

### General Description

The AAT9121 30V N-Channel Power MOSFET is a member of AnalogicTech's TrenchDMOS™ product family. Using the ultra-high density proprietary TrenchDMOS technology, this product demonstrates high power handling and small size.

### Features

- $V_{DS(MAX)} = 30V$
- $I_{D(MAX)} = 8A @ 25^{\circ}C$
- Low Gate Charge
- Low  $R_{DS(ON)}$ :
  - $24 m\Omega @ V_{GS} = 10V$
  - $35 m\Omega @ V_{GS} = 4.5V$

### Applications

- DC-DC converters for mobile CPUs
- Battery-powered portable equipment
- High power density DC - DC supplies
- Power supplies

### SOP-8 Package

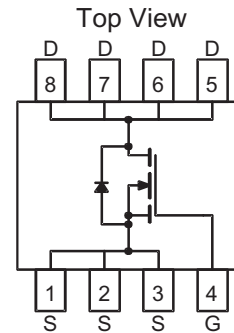

### Absolute Maximum Ratings ( $T_A=25^{\circ}C$ unless otherwise noted)

Symbol	Description	Value	Units	
$V_{DS}$	Drain-Source Voltage	30	V	
$V_{GS}$	Gate-Source Voltage	$\pm 20$		
$I_D$	Continuous Drain Current @ $T_J=150^{\circ}C$ <sup>1</sup>	$T_A = 25^{\circ}C$	$\pm 8.0$	A
		$T_A = 70^{\circ}C$	$\pm 6.4$	
$I_{DM}$	Pulsed Drain Current	$\pm 24$		
$I_S$	Continuous Source Current (Source-Drain Diode) <sup>1</sup>	2.25		
$P_D$	Maximum Power Dissipation <sup>1</sup>	$T_A = 25^{\circ}C$	2.5	W
		$T_A = 70^{\circ}C$	1.6	
$T_J, T_{STG}$	Operating Junction and Storage Temperature Range	-55 to 150	$^{\circ}C$	

### Thermal Characteristics

Symbol	Description	Value	Units
$R_{\theta JA}$	Typical Junction-to-Ambient <sup>1</sup>	50	$^{\circ}C/W$
$R_{\theta JC}$	Typical Junction-to-Case	28	$^{\circ}C/W$

Note 1: Mounted on 1" x 1" FR4 Copper Board, 10 sec pulse width.

### Electrical Characteristics (T<sub>J</sub>=25°C unless otherwise noted)

Symbol	Description	Conditions	Min	Typ	Max	Units
<b>DC Characteristics</b>						
BV <sub>DSS</sub>	Drain-Source Breakdown Voltage	V <sub>GS</sub> =0V, I <sub>D</sub> =250μA	30			V
R <sub>DS(ON)</sub>	Drain-Source ON-Resistance <sup>2</sup>	V <sub>GS</sub> =10V, I <sub>D</sub> =8A		16	24	mΩ
		V <sub>GS</sub> =4.5V, I <sub>D</sub> =6.6A		28	35	
I <sub>D(ON)</sub>	On-State Drain Current <sup>2</sup>	V <sub>GS</sub> =10V, V <sub>DS</sub> =5V (Pulsed)	24			A
V <sub>GS(th)</sub>	Gate Threshold Voltage	V <sub>GS</sub> =V <sub>DS</sub> , I <sub>D</sub> =250μA	1.0			V
I <sub>GSS</sub>	Gate-Body Leakage Current	V <sub>GS</sub> =±20V, V <sub>DS</sub> =0V			±100	nA
I <sub>DSS</sub>	Drain Source Leakage Current	V <sub>GS</sub> =0V, V <sub>DS</sub> =30V			1	μA
		V <sub>GS</sub> =0V, V <sub>DS</sub> =30V, T <sub>J</sub> =55°C			5	
g <sub>fs</sub>	Forward Transconductance <sup>2</sup>	V <sub>DS</sub> =15V, I <sub>D</sub> =8A		15		S
<b>Dynamic Characteristics <sup>3</sup></b>						
Q <sub>G</sub>	Total Gate Charge	V <sub>DS</sub> =15V, I <sub>D</sub> =8A, V <sub>GS</sub> =5V		10.5	16	nC
Q <sub>GT</sub>	Total Gate Charge	V <sub>DS</sub> =15V, I <sub>D</sub> =8A, V <sub>GS</sub> =10V		20.5	28	nC
Q <sub>GS</sub>	Gate-Source Charge	V <sub>DS</sub> =15V, I <sub>D</sub> =8A, V <sub>GS</sub> =10V		3.8		nC
Q <sub>GD</sub>	Gate-Drain Charge	V <sub>DS</sub> =15V, I <sub>D</sub> =8A, V <sub>GS</sub> =10V		2.9		nC
t <sub>D(ON)</sub>	Turn-ON Delay	V <sub>DD</sub> =15V, V <sub>GS</sub> =10V, R <sub>D</sub> =1.8Ω, R <sub>G</sub> =6Ω		9	15	ns
t <sub>R</sub>	Turn-ON Rise Time	V <sub>DD</sub> =15V, V <sub>GS</sub> =10V, R <sub>D</sub> =1.8Ω, R <sub>G</sub> =6Ω		12	20	ns
t <sub>D(OFF)</sub>	Turn-OFF Delay	V <sub>DD</sub> =15V, V <sub>GS</sub> =10V, R <sub>D</sub> =1.8Ω, R <sub>G</sub> =6Ω		38	55	ns
t <sub>F</sub>	Turn-OFF Fall Time	V <sub>DD</sub> =15V, V <sub>GS</sub> =10V, R <sub>D</sub> =1.8Ω, R <sub>G</sub> =6Ω		19	28	ns
<b>Source-Drain Diode Characteristics</b>						
V <sub>SD</sub>	Source-Drain Forward Voltage <sup>2</sup>	V <sub>GS</sub> =0, I <sub>S</sub> =2.25A			1.1	V
I <sub>S</sub>	Continuous Diode Current <sup>2</sup>	T <sub>A</sub> =25°C			2.25	A

Note 2: Pulse test: Pulse Width = 300μs

Note 3: Guaranteed by design. Not subjected to production testing.

### Typical Characteristics

( $T_J = 25^\circ\text{C}$  unless otherwise noted)

**Forward Characteristics**

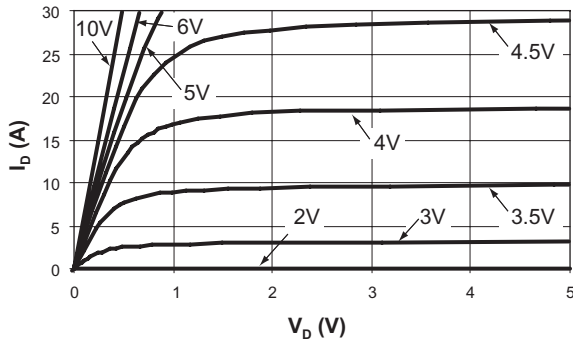

**Normalized  $R_{DS(ON)}$**

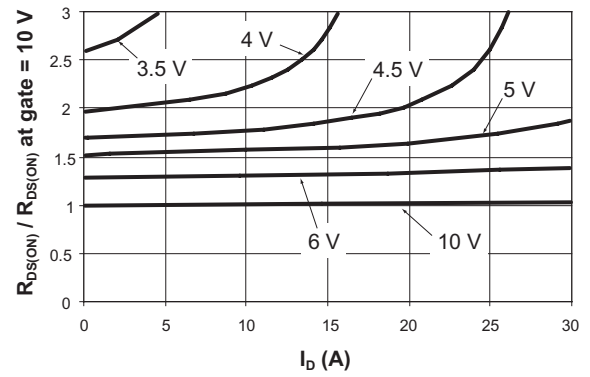

**$R_{DS(ON)}$  vs.  $V_G$**

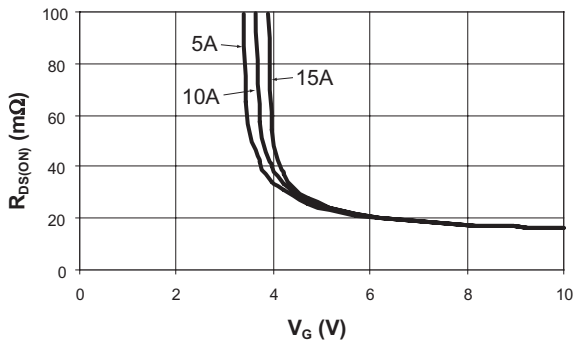

**Transfer**

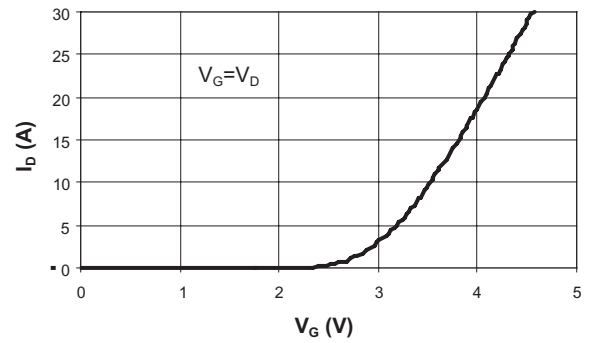

**Source to Drain Voltage**

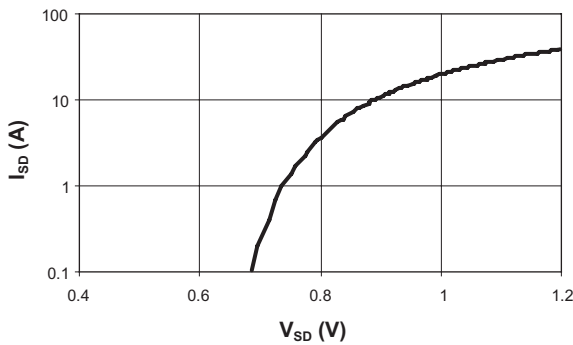

**Gate Charge Characteristics**

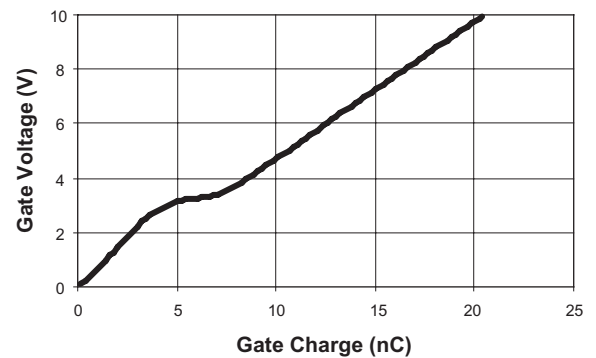

### Ordering Information

Package	Marking	Part Number	
		Bulk	Tape and Reel
SOP-8		AAT9121IAS-B1	AAT9121IAS-T1

### Package Information

SOP-8

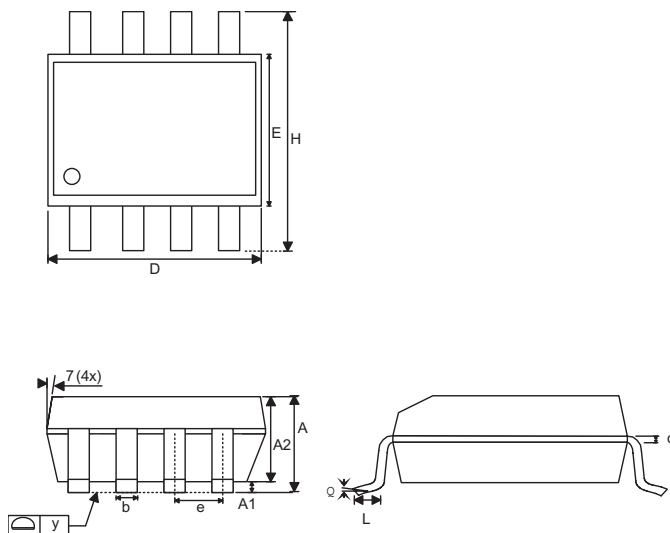

Dim	Millimeters		Inches	
	Min	Max	Min	Max
A	1.35	1.75	0.053	0.069
A1	0.10	0.25	0.004	0.010
A2	1.45		0.057	
B	0.33	0.51	0.013	0.020
C	0.19	0.25	0.007	0.010
D	4.80	5.00	0.189	0.197
E	3.80	4.00	0.150	0.157
e	1.27		0.050	
H	5.80	6.20	0.228	0.244
L	0.40	1.27	0.016	0.050
Y	0.00	0.10	0.000	0.004
θ1	0°	8°	0°	8°

Note:

1. PACKAGE BODY SIZES EXCLUDE MOLD FLASH PROTRUSIONS OR GATE BURRS.
2. TOLERANCE 0.1000mm (4mil) UNLESS OTHERWISE SPECIFIED
3. COPLANARITY: 0.1000mm
4. DIMENSION L IS MEASURED IN GAGE PLANE.
5. CONTROLLING DIMENSION IS MILLIMETER; CONVERTED INCH DIMENSIONS ARE NOT NECESSARILY EXACT.