



Low Distortion 1.5 Watt Audio Power Amplifier

SSM2211*

FEATURES

- 1.5 Watt Output¹
- Differential (BTL²) Output
- Single-Supply Operation: 2.7 V to 5.5 V
- Functions Down to 1.75 V
- Wide Bandwidth: 4 MHz
- Highly Stable, Phase Margin: > 80 Degrees
- Low Distortion: 0.2% THD @ 1 W Output
- Excellent Power Supply Rejection

APPLICATIONS

- Portable Computers
- Personal Wireless Communicators
- Hands-Free Telephones
- Speakerphones
- Intercoms
- Musical Toys and Speaking Games

GENERAL DESCRIPTION

The SSM2211 is a high performance audio amplifier that delivers 1 W RMS of low distortion audio power into a bridge-connected 8 Ω speaker load, (or 1.5 W RMS into 4 Ω load). It operates over a wide temperature range and is specified for single-supply voltages between 2.7 V and 5.5 V. When operating from batteries, it will continue to operate down to 1.75 V. This makes the SSM2211 the best choice for unregulated applications such as toys and games. Featuring a 4 MHz bandwidth, distortion below 0.2 % THD @ 1 W, and the patented Thermal Coastline leadframe, superior performance is delivered at higher power or lower speaker load impedance than competitive units. The advanced mechanical packaging of the SSM2211 gives lower chip temperature, which ensures highly reliable operation and enhanced trouble free life.

FUNCTIONAL BLOCK DIAGRAM

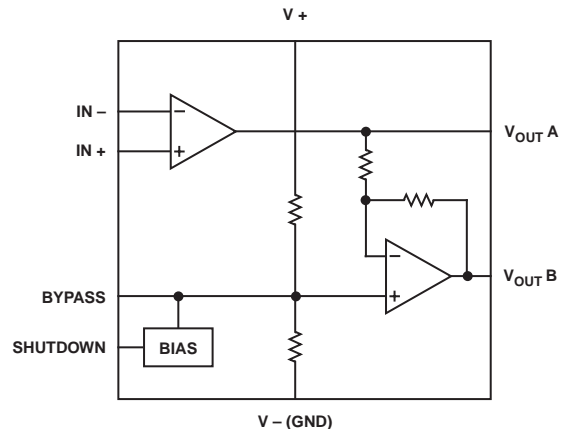

The low differential dc output voltage results in negligible losses in the speaker winding, and makes high value dc blocking capacitors unnecessary. Battery life is extended by using the Shutdown mode, which reduces quiescent current drain to typically 100 nA.

The SSM2211 is designed to operate over the -20°C to $+85^{\circ}\text{C}$ temperature range. See Figure 49 for information on the Thermal Coastline lead frame. The SSM2211 is available in an SO-8 surface mount package. DIP samples are available; you should request a special quotation on production quantities. An evaluation board is available upon request of your local Analog Device sales office.

Applications include personal portable computers, hands-free telephones and transceivers, talking toys, intercom systems and other low voltage audio systems requiring 1 W output power.

*Protected by U.S. Patent No. 5,519,576

¹1.5 W @ 4 Ω , +25 $^{\circ}\text{C}$ ambient, < 1% THD, 5 V supply, 4 layer PCB.

²Bridge Tied Load

REV. 0

Information furnished by Analog Devices is believed to be accurate and reliable. However, no responsibility is assumed by Analog Devices for its use, nor for any infringements of patents or other rights of third parties which may result from its use. No license is granted by implication or otherwise under any patent or patent rights of Analog Devices.

One Technology Way, P.O. Box 9106, Norwood, MA 02062-9106, U.S.A.
Tel: 781/329-4700 World Wide Web Site: <http://www.analog.com>
Fax: 781/326-8703 © Analog Devices, Inc., 1997

SSM2211–SPECIFICATIONS

ELECTRICAL CHARACTERISTICS ($V_S = +5.0\text{ V}$, $T_A = +25^\circ\text{C}$, $R_L = 8\ \Omega$, $C_B = 0.1\ \mu\text{F}$, $V_{CM} = V_D/2$ unless otherwise noted)

Parameter	Symbol	Conditions	Min	Typ	Max	Units
GENERAL CHARACTERISTICS						
Differential Output Offset Voltage	V_{OOS}	$A_{VD} = 2$		4	50	mV
Output Impedance	Z_{OUT}			0.1		Ω
SHUTDOWN CONTROL						
Input Voltage High	V_{IH}	$I_{SY} < 100\ \mu\text{A}$	3.0			V
Input Voltage Low	V_{IL}	$I_{SY} = \text{Normal}$			1.3	V
POWER SUPPLY						
Power Supply Rejection Ratio	PSRR	$V_S = 4.75\text{ V to } 5.25\text{ V}$		66		dB
Supply Current	I_{SY}	$V_{O1} = V_{O2} = 2.5\text{ V}$		9.5		mA
Supply Current, Shutdown Mode	I_{SD}	Pin 1 = V_{DD} , See Figure 29		100		nA
DYNAMIC PERFORMANCE						
Gain Bandwidth	GBP			4		MHz
Phase Margin	ϕ^0			86		degrees
AUDIO PERFORMANCE						
Total Harmonic Distortion	THD + N	P = 0.5 W into 8 Ω , f = 1 kHz		0.15		%
Total Harmonic Distortion	THD + N	P = 1.0 W into 8 Ω , f = 1 kHz		0.2		%
Voltage Noise Density	e_n	f = 1 kHz		85		$\text{nV}\sqrt{\text{Hz}}$

ELECTRICAL CHARACTERISTICS ($V_S = +3.3\text{ V}$, $T_A = +25^\circ\text{C}$, $R_L = 8\ \Omega$, $C_B = 0.1\ \mu\text{F}$, $V_{CM} = V_D/2$ unless otherwise noted)

Parameter	Symbol	Conditions	Min	Typ	Max	Units
GENERAL CHARACTERISTICS						
Differential Output Offset Voltage	V_{OOS}	$A_{VD} = 2$		5	50	mV
Output Impedance	Z_{OUT}			0.1		Ω
SHUTDOWN INPUT						
Input Voltage High	V_{IH}	$I_{SY} < 100\ \mu\text{A}$	1.7			V
Input Voltage Low	V_{IL}				1	V
POWER SUPPLY						
Supply Current	I_{SY}	$V_{O1} = V_{O2} = 1.65\text{ V}$		5.2		mA
Supply Current, Shutdown Mode	I_{SD}	Pin 1 = V_{DD} , See Figure 29		100		nA
AUDIO PERFORMANCE						
Total Harmonic Distortion	THD + N	P = 0.35 W into 8 Ω , f = 1 kHz		0.1		%

ELECTRICAL CHARACTERISTICS ($V_S = +2.7\text{ V}$, $T_A = +25^\circ\text{C}$, $R_L = 8\ \Omega$, $C_B = 0.1\ \mu\text{F}$, $V_{CM} = V_S/2$ unless otherwise noted)

Parameter	Symbol	Conditions	Min	Typ	Max	Units
GENERAL CHARACTERISTICS						
Differential Output Offset Voltage	V_{OOS}	$A_{VD} = 2$		5	50	mV
Output Impedance	Z_{OUT}			0.1		Ω
SHUTDOWN CONTROL						
Input Voltage High	V_{IH}	$I_{SY} < 100\ \mu\text{A}$	1.5			V
Input Voltage Low	V_{IL}	$I_{SY} = \text{Normal}$			0.8	V
POWER SUPPLY						
Supply Current	I_{SY}	$V_{O1} = V_{O2} = 1.35\text{ V}$		4.2		mA
Supply Current, Shutdown Mode	I_{SD}	Pin 1 = V_{DD} , See Figure 29		100		nA
AUDIO PERFORMANCE						
Total Harmonic Distortion	THD + N	P = 0.25 W into 8 Ω , f = 1 kHz		0.1		%

Specifications subject to change without notice

ABSOLUTE MAXIMUM RATINGS^{1,2}

Supply Voltage	+6 V
Input Voltage	V_{DD}
Common Mode Input Voltage	V_{DD}
ESD Susceptibility	2000 V
Storage Temperature Range	-65°C to +150°C
Operating Temperature Range	-20°C to +85°C
Junction Temperature Range	-65°C to +165°C
Lead Temperature Range (Soldering, 60 sec)	+300°C

NOTES

¹Absolute maximum ratings apply at +25°C, unless otherwise noted.

²Stresses above those listed under Absolute Maximum Ratings may cause permanent damage to the device. This is a stress rating only; the functional operation of the device at these or any other conditions above those indicated in the operational sections of this specification is not implied. Exposure to absolute maximum rating conditions for extended periods may affect device reliability.

Package Type	θ_{JA} ¹	θ_{JC}	Units
8-Lead SOIC (S)	98	43	°C/W
8-Lead PDIP (P) ²	103	43	°C/W

NOTES

¹For the SOIC package, θ_{JA} is measured with the device soldered to a 4-layer printed circuit board.

²Special order only.

ORDERING GUIDE

Model	Temperature Range	Package Description	Package Options
SSM2211S	-20°C to +85°C	8-Lead SOIC	SO-8
SSM2211S-reel	-20°C to +85°C	8-Lead SOIC	SO-8
SSM2211S-reel7	-20°C to +85°C	8-Lead SOIC	SO-8
SSM2211P	-20°C to +85°C	8-Lead PDIP	N-8*

*Special order only.

PIN CONFIGURATIONS

8-Lead SOIC (SO-8)

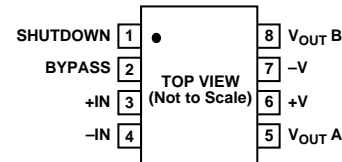

8-Lead Plastic DIP (N-8)

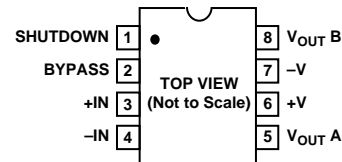

CAUTION

ESD (electrostatic discharge) sensitive device. Electrostatic charges as high as 4000 V readily accumulate on the human body and test equipment and can discharge without detection. Although the SSM2211 features proprietary ESD protection circuitry, permanent damage may occur on devices subjected to high energy electrostatic discharges. Therefore, proper ESD precautions are recommended to avoid performance degradation or loss of functionality.

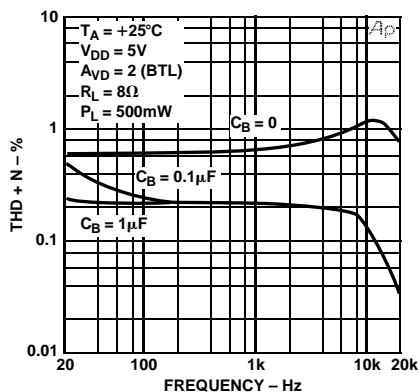

Figure 1. THD+N vs. Frequency

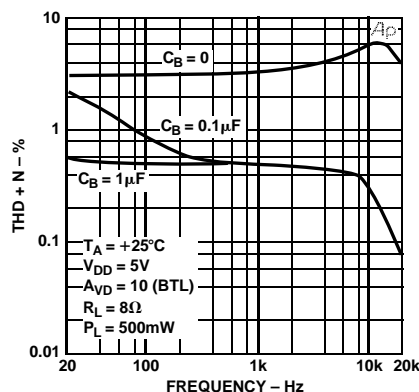

Figure 2. THD+N vs. Frequency

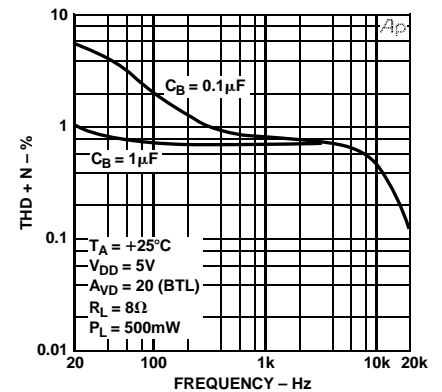

Figure 3. THD+N vs. Frequency

SSM2211–Typical Performance Characteristics

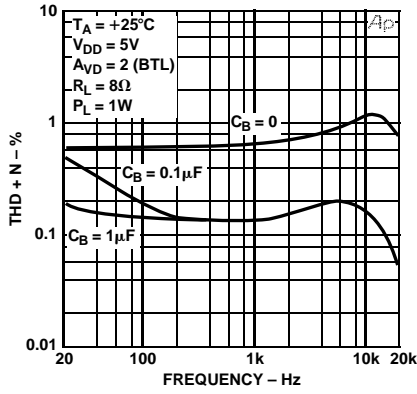

Figure 4. THD+N vs. Frequency

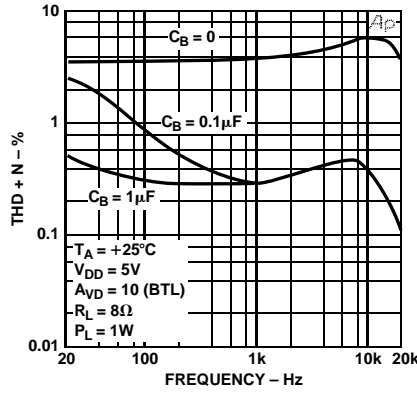

Figure 5. THD+N vs. Frequency

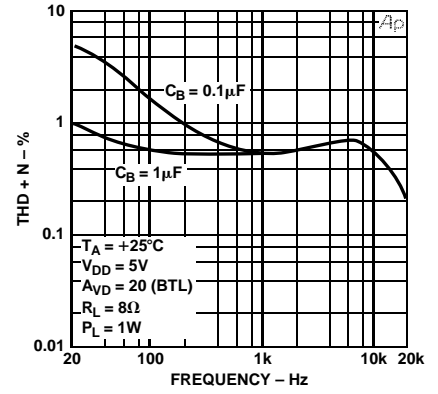

Figure 6. THD+N vs. Frequency

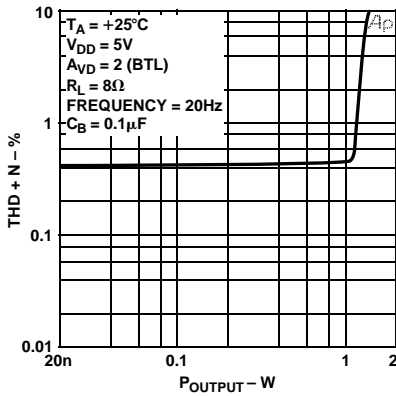

Figure 7. THD+N vs. P_{OUTPUT}

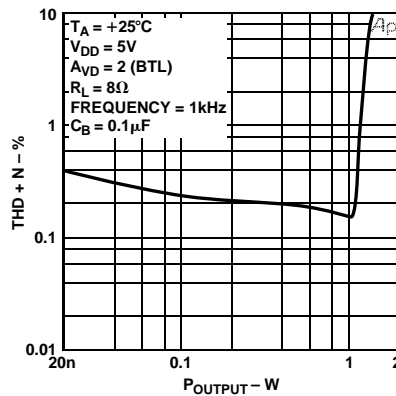

Figure 8. THD+N vs. P_{OUTPUT}

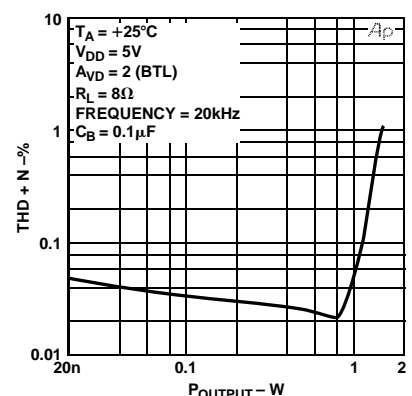

Figure 9. THD+N vs. P_{OUTPUT}

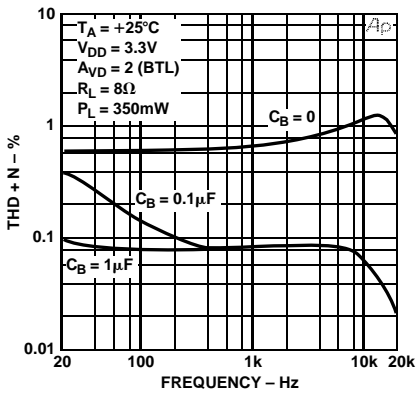

Figure 10. THD+N vs. Frequency

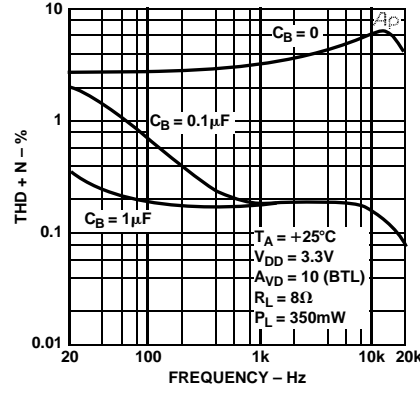

Figure 11. THD+N vs. Frequency

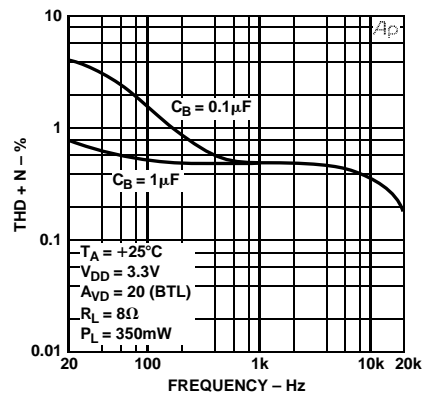

Figure 12. THD+N vs. Frequency

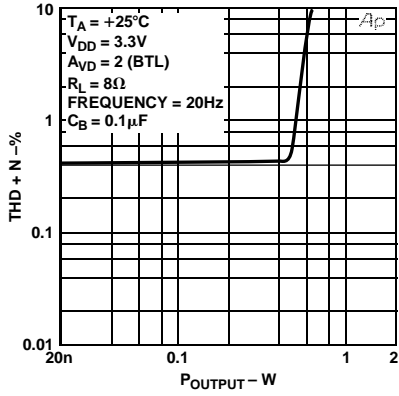

Figure 13. THD+N vs. P_{OUTPUT}

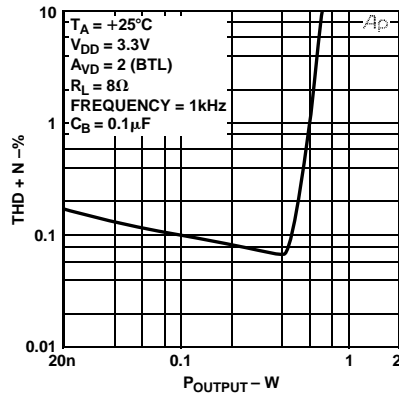

Figure 14. THD+N vs. P_{OUTPUT}

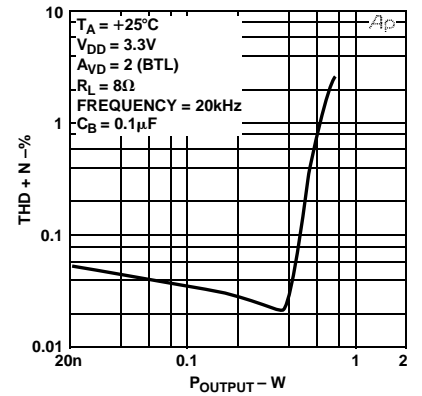

Figure 15. THD+N vs. Frequency

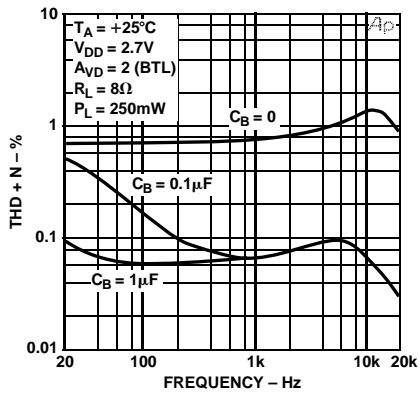

Figure 16. THD+N vs. Frequency

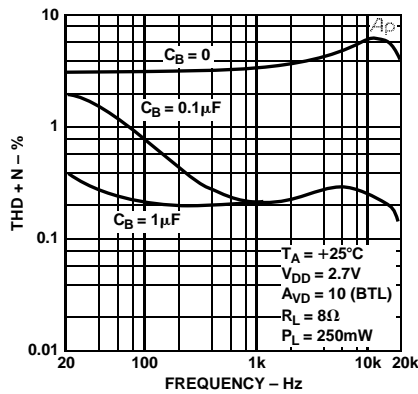

Figure 17. THD+N vs. Frequency

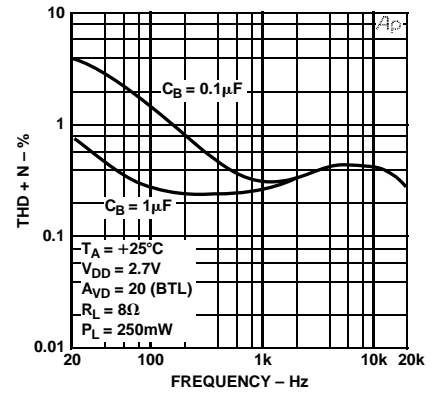

Figure 18. THD+N vs. Frequency

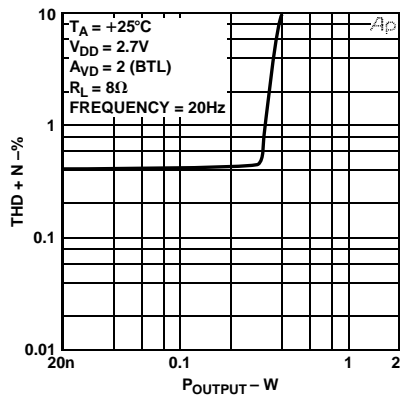

Figure 19. THD+N vs. P_{OUTPUT}

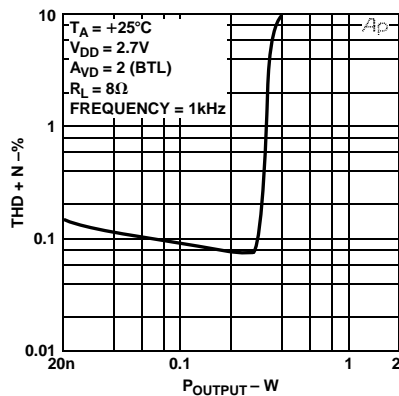

Figure 20. THD+N vs. P_{OUTPUT}

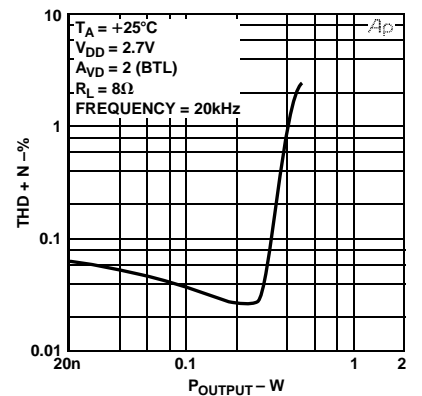

Figure 21. THD+N vs. P_{OUTPUT}

SSM2211–Typical Performance Characteristics

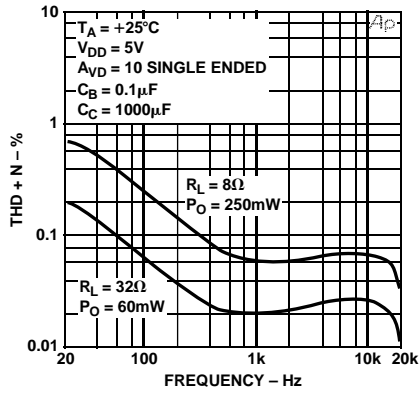

Figure 22. THD+N vs. Frequency

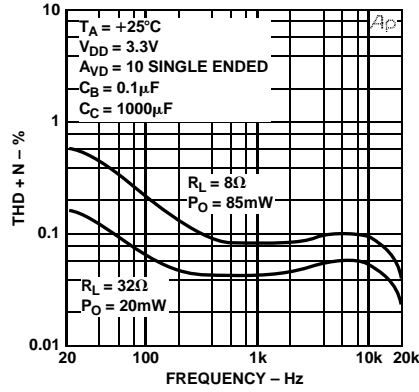

Figure 23. THD+N vs. Frequency

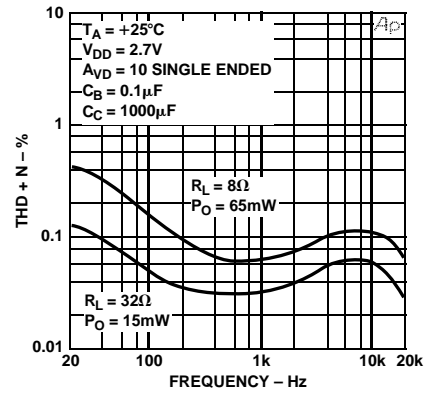

Figure 24. THD+N vs. Frequency

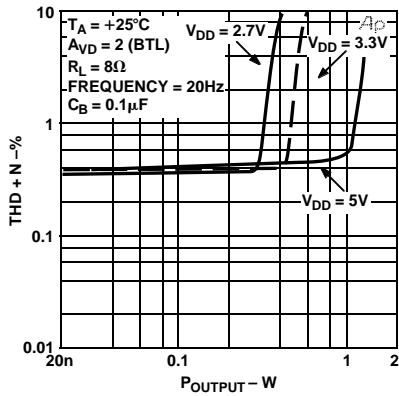

Figure 25. THD+N vs. P_{OUTPUT}

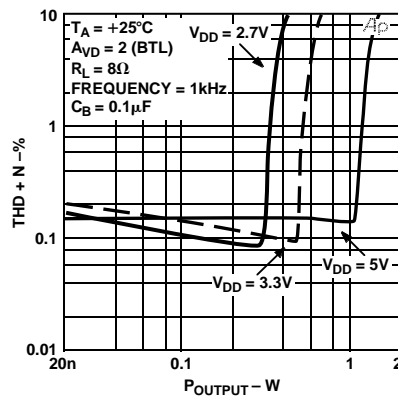

Figure 26. THD+N vs. P_{OUTPUT}

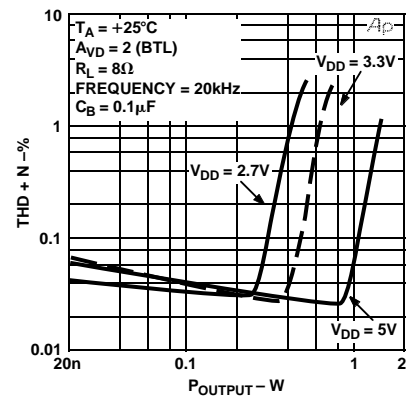

Figure 27. THD+N vs. P_{OUTPUT}

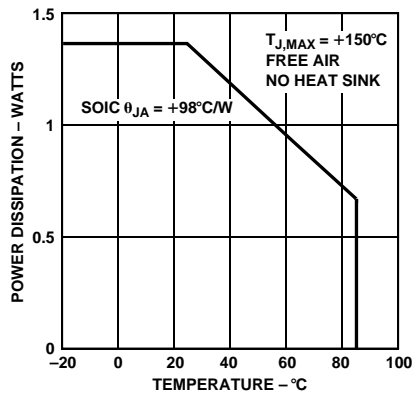

Figure 28. Maximum Power Dissipation vs. Ambient Temperature

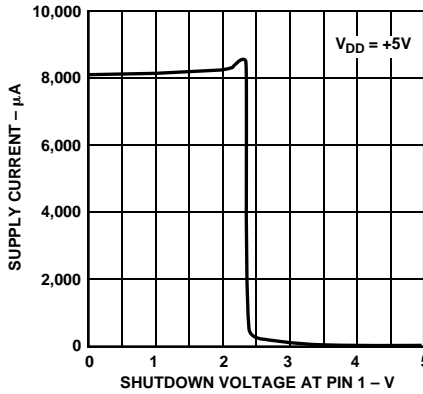

Figure 29. Supply Current vs. Shutdown Voltage

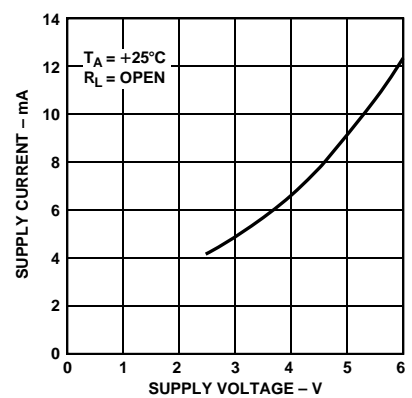

Figure 30. Supply Current vs. Supply Voltage

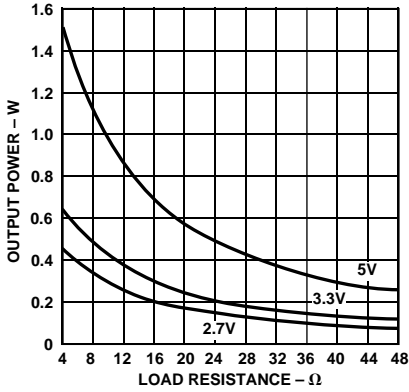

Figure 31. P_{OUTPUT} VS. Load Resistance

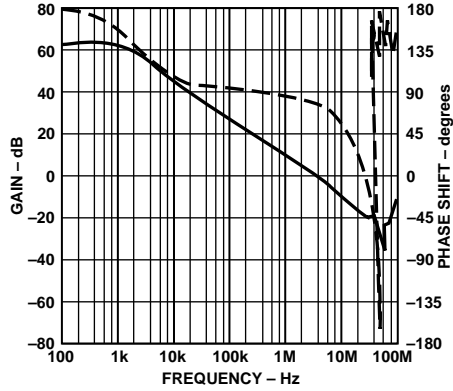

Figure 32. Gain, Phase vs. Frequency (Single Amplifier)

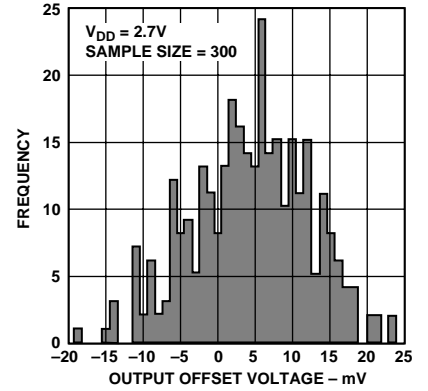

Figure 33. Output Offset Voltage Distribution

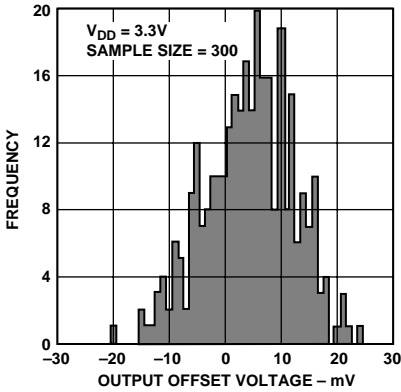

Figure 34. Output Offset Voltage Distribution

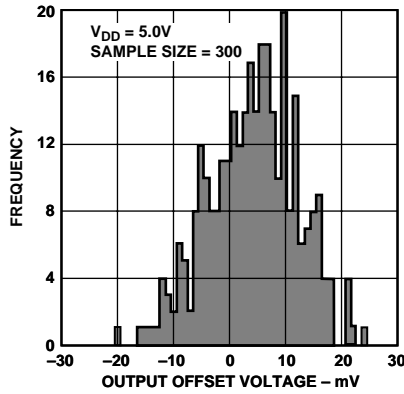

Figure 35. Output Offset Voltage Distribution

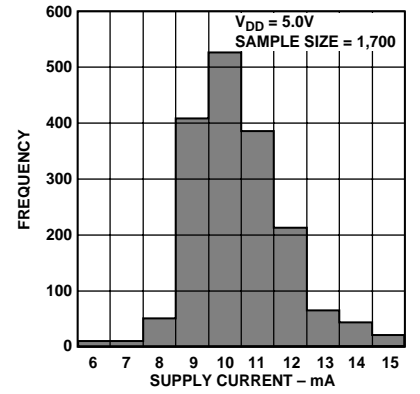

Figure 36. Supply Current Distribution

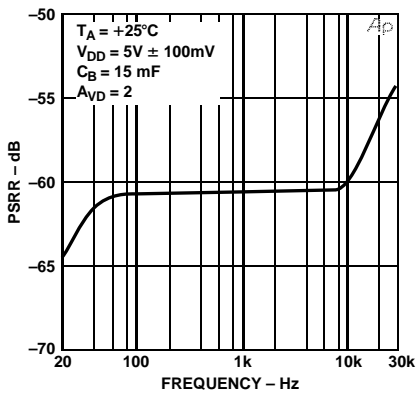

Figure 37. PSRR vs. Frequency

SSM2211

SSM2211 PRODUCT OVERVIEW

The SSM2211 is a low distortion speaker amplifier that can run from a 1.7 V to 5.5 V supply. It consists of a rail-to-rail input and a differential output that can be driven within 400 mV of either supply rail while supplying a sustained output current of 350 mA. The SSM2211 is unity-gain stable, requiring no external compensation capacitors, and can be configured for gains of up to 40 dB. Figure 38 shows the simplified schematic.

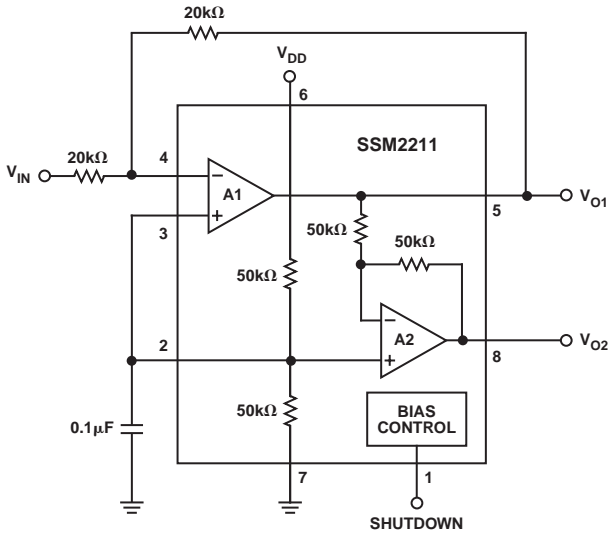

Figure 38. Simplified Schematic

Pin 4 and Pin 3 are the inverting and noninverting terminals to A1. An offset voltage is provided at Pin 2, which should be connected to Pin 3 for use in single supply applications. The output of A1 appears at Pin 5. A second op amp, A2, is configured with a fixed gain of $A_v = -1$ and produces an inverted replica of Pin 5 at Pin 8. The SSM2211 outputs at Pins 5 and 8 produce a bridged configuration output to which a speaker can be connected. This bridge configuration offers the advantage of a more efficient power transfer from the input to the speaker. Because both outputs are symmetric, the dc bias at Pins 5 and 8 are exactly equal, resulting in zero dc differential voltage across the outputs. This eliminates the need for a coupling capacitor at the output.

The SSM2211 can achieve 1 W continuous output into 8 Ω, even at ambient temperatures up to +85°C. This is due to a proprietary SOIC package from Analog Devices that makes use of an internal structure called a Thermal Coastline. The Thermal Coastline provides a more efficient heat dissipation from the die than in standard SOIC packages. This increase in heat dissipation allows the device to operate in higher ambient temperatures or at higher continuous output currents without overheating the die.

For a standard SOIC package, typical junction to ambient temperature thermal resistance (θ_{JA}) is +158°C/W. In a Thermal Coastline SOIC package, θ_{JA} is +98°C/W. Simply put, a die in a Thermal Coastline package will not get as hot as a die in a standard SOIC package at the same current output.

Because of the large amounts of power dissipated in a speaker amplifier, competitor's parts operating from a 5 V supply can only drive 1 W into 8 Ω in ambient temperatures less than +44°C, or +111°F. With the Thermal Coastline SOIC package, the SSM2211 can drive an 8 Ω speaker with 1 W from a 5 V supply with ambient temperatures as high as +85°C (+185°F), without a heat sink or forced air flow.

TYPICAL APPLICATION

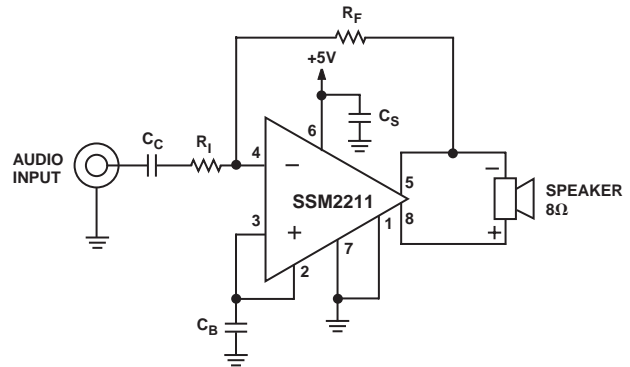

Figure 39. A Typical Configuration

Figure 39 shows how the SSM2211 would be connected in a typical application. The SSM2211 can be configured for gain much like a standard op amp. The gain from the audio input to the speaker is:

$$A_v = 2 \times \frac{R_F}{R_I} \quad (1)$$

The $\times 2$ factor comes from the fact that Pin 8 is opposite polarity from Pin 5, providing twice the voltage swing to the speaker from the bridged output configuration.

C_S is a supply bypass capacitor to provide power supply filtering. Pin 2 is connected to Pin 3 to provide an offset voltage for single supply use, with C_B providing a low AC impedance to ground to help power supply rejection. Because Pin 4 is a virtual AC ground, the input impedance is equal to R_I . C_C is the input coupling capacitor which also creates a high-pass filter with a corner frequency of:

$$f_{HP} = \frac{1}{2 \pi R_I \times C_C} \quad (2)$$

Because the SSM2211 has an excellent phase margin, a feedback capacitor in parallel with R_F to band-limit the amplifier is not required, as it is in some competitor's products.

Bridged Output vs. Single Ended Output Configurations

The power delivered to a load with a sinusoidal signal can be expressed in terms of the signal's peak voltage and the resistance of the load:

$$P_L = \frac{V_{PK}^2}{2 R_L} \quad (3)$$

By driving a load from a bridged output configuration, the voltage swing across the load doubles. An advantage in using a bridged output configuration becomes apparent from Equation 3 as doubling the peak voltage results in four times the power delivered to the load. In a typical application operating from a 5 V supply, the maximum power that can be delivered by the SSM2211 to an 8 Ω speaker in a single ended configuration is 250 mW. By driving this speaker with a bridged output, 1 W of power can be delivered. This translates to a 12 dB increase in sound pressure level from the speaker.

Driving a speaker differentially from a bridged output offers another advantage in that it eliminates the need for an output coupling capacitor to the load. In a single supply application, the quiescent voltage at the output is 1/2 of the supply voltage. If a speaker were connected in a single ended configuration, a coupling capacitor would be needed to prevent dc current from flowing through the speaker. This capacitor would also need to be large enough to prevent low frequency roll-off. The corner frequency is given by:

$$f_{-3dB} = \frac{1}{2\pi R_L C_C} \quad (4)$$

Where R_L is the speaker resistance and,
 C_C is the coupling capacitance

For an 8 Ω speaker and a corner frequency of 20 Hz, a 1000 μ F capacitor would be needed, which is quite physically large and costly. By connecting a speaker in a bridged output configuration, the quiescent differential voltage across the speaker becomes nearly zero, eliminating the need for the coupling capacitor.

Speaker Efficiency and Loudness

The effective loudness of 1 W of power delivered into an 8 Ω speaker is a function of the efficiency of the speaker. The efficiency of a speaker is typically rated as the sound pressure level (SPL) at 1 meter in front of the speaker with 1 W of power applied to the speaker. Most speakers are between 85 dB and 95 dB SPL at 1 meter at 1 W. Table I shows a comparison of the relative loudness of different sounds.

Table I. Typical Sound Pressure Levels

Source of Sound	dB SPL
Threshold of Pain	120
Heavy Street Traffic	95
Cabin of Jet Aircraft	80
Average Conversation	65
Average Home at Night	50
Quiet Recording Studio	30
Threshold of Hearing	0

It can easily be seen that 1 W of power into a speaker can produce quite a bit of acoustic energy.

Power Dissipation

Another important advantage in using a bridged output configuration is the fact that bridged output amplifiers are more efficient than single ended amplifiers in delivering power to a load. Efficiency is defined as the ratio of power from the power supply

to the power delivered to the load $\left(\eta = \frac{P_L}{P_{SY}}\right)$. An amplifier

with a higher efficiency has less internal power dissipation, which results in a lower die-to-case junction temperature, as compared to an amplifier that is less efficient. This is important when considering the amplifier device's maximum power dissipation rating versus ambient temperature. An internal power dissipation versus output power equation can be derived to fully understand this.

The internal power dissipation of the amplifier is the internal voltage drop multiplied by the average value of the supply current. An easier way to find internal power dissipation is to take the difference between the power delivered by the supply voltage source and the power delivered into the load. The waveform of the supply current for a bridged output amplifier is shown in Figure 40.

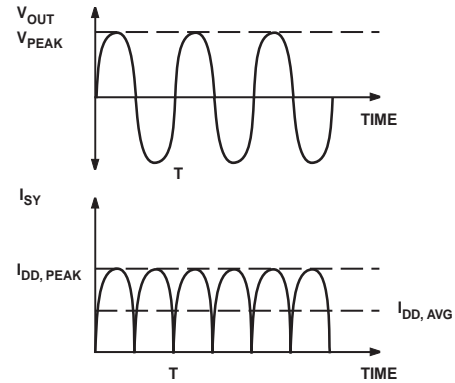

Figure 40. Bridged Amplifier Output Voltage and Supply Current vs. Time

By integrating the supply current over a period T, then dividing the result by T, $I_{DD,AVG}$ can be found. Expressed in terms of peak output voltage and load resistance:

$$I_{DD,AVG} = \frac{2V_{PEAK}}{\pi R_L} \quad (5)$$

therefore power delivered by the supply, neglecting the bias current for the device is,

$$P_{SY} = \frac{2V_{DD}V_{PEAK}}{\pi R_L} \quad (6)$$

Now, the power dissipated by the amplifier internally is simply the difference between Equation 6 and Equation 3. The equation for internal power dissipated, P_{DISS} , expressed in terms of power delivered to the load and load resistance is:

$$P_{DISS} = \frac{2\sqrt{2} \times V_{DD} \sqrt{P_L} - P_L}{\pi \sqrt{R_L}} \quad (7)$$

The graph of this equation is shown in Figure 41.

SSM2211

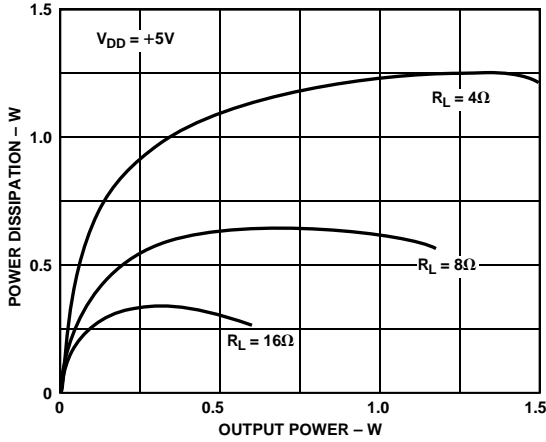

Figure 41. Power Dissipation vs. Output Power with $V_{DD} = 5\text{ V}$

Because the efficiency of a bridged output amplifier (Equation 3 divided by Equation 6) increases with the square root of P_L , the power dissipated internally by the device stays relatively flat, and will actually decrease with higher output power. The maximum power dissipation of the device can be found by differentiating Equation 7 with respect to load power, and setting the derivative equal to zero. This yields:

$$\frac{\partial P_{DISS}}{\partial P_L} = \frac{\sqrt{2} \times V_{DD}}{\pi R_L} P_L^{-1/2} - 1 = 0 \quad (8)$$

And this occurs when:

$$P_{DISS,MAX} = \frac{2 V_{DD}^2}{\pi^2 R_L} \quad (9)$$

Using Equation 9 and the power derating curve in Figure 28, the maximum ambient temperature can be easily found. This insures that the SSM2211 will not exceed its maximum junction temperature of 150°C.

The power dissipation for a single ended output application where the load is capacitively coupled is given by:

$$\partial P_{DISS} = \frac{2\sqrt{2} \times V_{DD}}{\pi \sqrt{R_L}} \sqrt{P_L} - P_L \quad (10)$$

The graph of Equation 10 is shown in Figure 42.

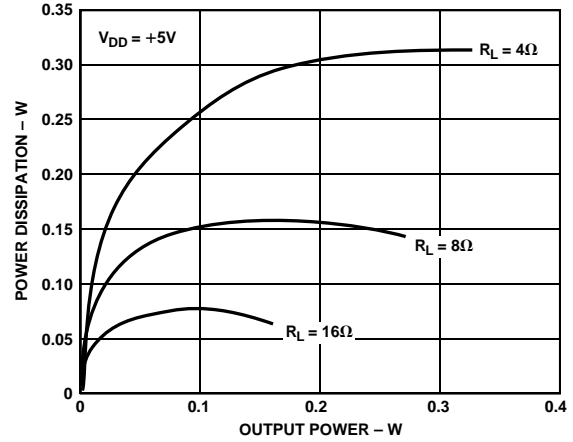

Figure 42. Power Dissipation vs. Single Ended Output Power with ($V_{DD} = 5\text{ V}$)

The maximum power dissipation for a single ended output is:

$$P_{DISS,MAX} = \frac{V_{DD}^2}{2 \pi^2 R_L} \quad (11)$$

Output Voltage Headroom

The outputs of both amplifiers in the SSM2211 can come to within 400 mV of either supply rail while driving an 8 Ω load. As compared to other competitors' equivalent products, the SSM2211 has a higher output voltage headroom. This means that the SSM2211 can deliver an equivalent maximum output power while running from a lower supply voltage. By running at a lower supply voltage, the internal power dissipation of the device is reduced, as can be seen from Equation 9. This extended output headroom, along with the Thermal Coastline package, allows the SSM2211 to operate in higher ambient temperatures than other competitors' devices.

The SSM2211 is also capable of providing amplification even at supply voltages as low as 1.7 V. Of course, the maximum power available at the output is a function of the supply voltage. Therefore, as the supply voltage decreases, so does the maximum power output from the device. Figure 43 shows the maximum output power versus supply voltage at various bridged-tied load resistances. The maximum output power is defined as the point at which the output has 1% THD.

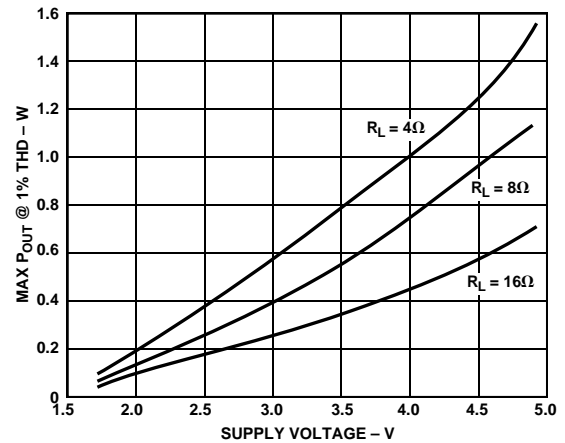

Figure 43. Maximum Output Power vs. V_{SY}

To find the minimum supply voltage needed to achieve a specified maximum undistorted output power, simply use Figure 43.

For example, an application requires only 500 mW to be output for an 8 Ω speaker. With the speaker connected in a bridged output configuration, the minimum supply voltage required is 3.3 V.

Shutdown Feature

The SSM2211 can be put into a low power consumption shutdown mode by connecting Pin 1 to 5 V. In shutdown mode, the SSM2211 has an extremely low supply current of less than 10 nA. This makes the SSM2211 ideal for battery powered applications.

Pin 1 should be connected to ground for normal operation. Connecting Pin 1 to V_{DD} will mute the outputs and put the SSM2211 into shutdown mode. A pull-up or pull-down resistor is not required. Pin 1 should always be connected to a fixed potential, either V_{DD} or ground, and never be left floating. Leaving Pin 1 unconnected could produce unpredictable results.

Automatic Shutdown Sensing Circuit

Figure 44 shows a circuit that can be used to automatically take the SSM2211 in and out of shutdown mode. This circuit can be set to turn the SSM2211 on when an input signal of a certain amplitude is detected. The circuit will also put the SSM2211 into its low-power shutdown mode once an input signal is not sensed within a certain amount of time. This can be useful in a variety of portable radio applications where power conservation is critical.

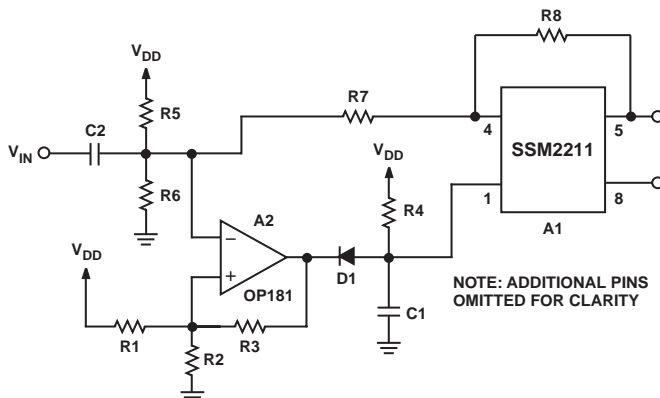

Figure 44. Automatic Shutdown Circuit

The input signal to the SSM2211 is also connected to the non-inverting terminal of A2. R1, R2, and R3 set the threshold voltage of when the SSM2211 will be taken out of shutdown mode. D1 half-wave rectifies the output of A2, discharging C1 to ground when an input signal greater than the set threshold voltage is detected. R4 controls the charge time of C1, which sets the time until the SSM2211 is put back into shutdown mode after the input signal is no longer detected.

R5 and R6 are used to establish a voltage reference point equal to half of the supply voltage. R7 and R8 set the gain of the SSM2211. D1 should be a 1N914 or equivalent diode and A2 should be a rail-to-rail output amplifier, such as an OP181 or equivalent. This will ensure that C1 will discharge sufficiently to bring the SSM2211 out of shutdown mode.

To find the appropriate component values, first the gain of A2 must be determined by:

$$A_{V, MIN} = \frac{V_{SY}}{V_{THS}} \quad (12)$$

Where, V_{SY} is the single supply voltage and, V_{THS} is the threshold voltage.

A_V should be set to a minimum of 2 for the circuit to work properly. Next choose R1 and set R2 to:

$$R2 = R1 \left(1 - \frac{2}{A_V} \right) \quad (13)$$

Find R3 as:

$$R3 = \frac{R1 \times R2}{R1 + R2} (A_V - 1) \quad (14)$$

C1 can be arbitrarily set, but should be small enough to not cause A2 to become capacitively overloaded. R4 and C1 will control the shutdown rate. To prevent intermittent shutdown with low frequency input signals, the minimum time constant should be:

$$R4 \times C1 \geq \frac{10}{f_{LOW}} \quad (15)$$

Where, f_{LOW} is the lowest input frequency expected.

Shutdown Circuit Design Example

In this example a portable radio application requires the SSM2211 to be turned on when an input signal greater than 50 mV is detected. The device should return to shutdown mode within 500 ms after the input signal is no longer detected. The lowest frequency of interest is 200 Hz, and a +5 V supply is being used.

The minimum gain of the shutdown circuit from Equation 12 is $A_V = 100$. R1 is set to 100 kΩ, and using Equation 13 and Equation 14, R2 = 98 kΩ and R3 = 4.9 MΩ. C1 is set to 0.01 μF, and based on Equation 15, R4 is set to 10 MΩ. To minimize power supply current, R5 and R6 are set to 10 MΩ.

The above procedure will provide an adequate starting point for the shutdown circuit. Some component values may need to be adjusted empirically to optimize performance.

Turn On Popping Noise

During power-up or release from shutdown mode, the midrail bypass capacitor, C_B , determines the rate at which the SSM2211 starts up. By adjusting the charging time constant of C_B , the start-up pop noise can be pushed into the sub-audible range, greatly reducing startup popping noise. On power-up, the midrail bypass capacitor is charged through an effective resistance of 25 kΩ. To minimize start-up popping, the charging time constant for C_B should be greater than the charging time constant for the input coupling capacitor, C_C .

$$C_B \times 25 \text{ k}\Omega > C_C R_I \quad (16)$$

SSM2211

For an application where $R_1 = 10\text{ k}\Omega$ and $C_C = 0.22\text{ }\mu\text{F}$, the midrail bypass capacitor, C_B , should be at least $0.1\text{ }\mu\text{F}$ to minimize start-up popping noise.

SSM2211 Amplifier Design Example

Given:

Maximum Output Power	1 W
Input Impedance	20 k Ω
Load Impedance	8 Ω
Input Level	1 V rms
Bandwidth	20 Hz – 20 kHz \pm 0.25 dB

The configuration shown in Figure 39 will be used. The first thing to determine is the minimum supply rail necessary to obtain the specified maximum output power. From Figure 43, for 1 W of output power into an 8 Ω load, the supply voltage must be at least 4.6 V. A supply rail of 5 V can be easily obtained from a voltage reference. The extra supply voltage will also allow the SSM2211 to reproduce peaks in excess of 1 W without clipping the signal. With $V_{DD} = 5\text{ V}$ and $R_L = 8\text{ }\Omega$, Equation 9 shows that the maximum power dissipation for the SSM2211 is 633 mW. From the power derating curve in Figure 28, the ambient temperature must be less than $+85^\circ\text{C}$.

The required gain of the amplifier can be determined from Equation 17:

$$A_V = \frac{\sqrt{P_L R_L}}{V_{IN,rms}} = 2.8 \quad (17)$$

From Equation 1, $\frac{R_F}{R_1} = \frac{A_V}{2}$, or $R_F = 1.4 \times R_1$. Since the desired input impedance is 20 k Ω , $R_1 = 20\text{ k}\Omega$ and $R_2 = 28\text{ k}\Omega$.

The final design step is to select the input capacitor. Because adding an input capacitor, C_C , high pass filter, the corner frequency needs to be far enough away for the design to meet the bandwidth criteria. For a 1st order filter to achieve a passband response within 0.25 dB, the corner frequency should be at least 4.14 times away from the passband frequency. So, $(4.14 \times f_{HP}) < 20\text{ Hz}$. Using Equation 2, the minimum size of input capacitor can be found:

$$C_C > \frac{1}{2\pi(20\text{ k}\Omega)\left(\frac{20\text{ Hz}}{4.14}\right)} \quad (18)$$

So $C_C > 1.65\text{ }\mu\text{F}$. Using a $2.2\text{ }\mu\text{F}$ is a practical choice for C_C .

The gain-bandwidth product for each internal amplifier in the SSM2211 is 4 MHz. Because 4 MHz is much greater than $4.14 \times 20\text{ kHz}$, the design will meet the upper frequency bandwidth criteria. The SSM2211 could also be configured for higher differential gains without running into bandwidth limitations.

Equation 16 shows an appropriate value for C_B to reduce start-up popping noise:

$$C_B > \frac{(2.2\text{ }\mu\text{F})(20\text{ k}\Omega)}{25\text{ k}\Omega} = 1.76\text{ }\mu\text{F} \quad (19)$$

Selecting C_B to be $2.2\text{ }\mu\text{F}$ for a practical value of capacitor will minimize start-up popping noise.

To summarize the final design:

V_{DD}	5 V
R_1	20 k Ω
R_F	28 k Ω
C_C	2.2 μF
C_B	2.2 μF
Max. T_A	$+85^\circ\text{C}$

Single Ended Applications

There are applications where driving a speaker differentially is not practical. An example would be a pair of stereo speakers where the minus terminal of both speakers is connected to ground. Figure 45 shows how this can be accomplished.

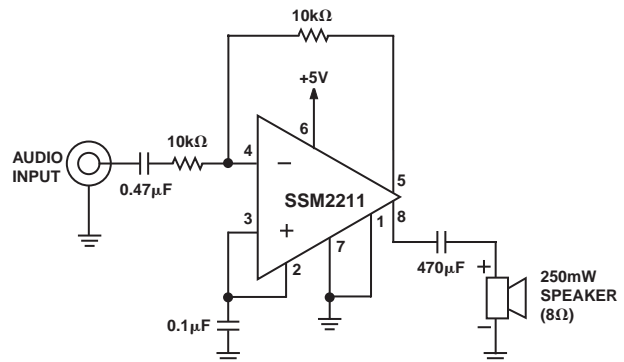

Figure 45. A Single Ended Output Application

It is not necessary to connect a dummy load to the unused output to help stabilize the output. The $470\text{ }\mu\text{F}$ coupling capacitor creates a high pass frequency cutoff as given in Equation 4 of 42 Hz, which is acceptable for most computer speaker applications.

The overall gain for a single ended output configuration is $A_V = R_F/R_1$, which for this example is equal to 1.

Driving Two Speakers Single Endedly

It is possible to drive two speakers single endedly with both outputs of the SSM2211.

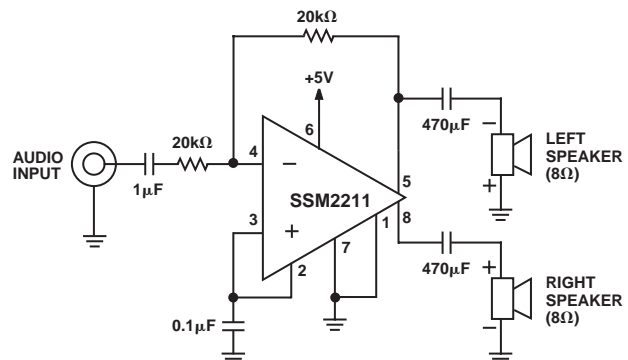

Figure 46. SSM2211 Used as a Dual Speaker Amplifier

Each speaker is driven by a single ended output. The trade-off is that only 250 mW sustained power can be put into each speaker. Also, a coupling capacitor must be connected in series with each of the speakers to prevent large DC currents from flowing through the 8 Ω speakers. These coupling capacitors

will produce a high pass filter with a corner frequency given by Equation 4. For a speaker load of $8\ \Omega$ and a coupling capacitor of $470\ \mu\text{F}$, this results in a $-3\ \text{dB}$ frequency of $42\ \text{Hz}$.

Because the power of a single ended output is one quarter that of a bridged output, both speakers together would still be half as loud ($-6\ \text{dB SPL}$) as a single speaker driven with a bridged output.

The polarity of the speakers is important, as each output is 180° out of phase with the other. By connecting the minus terminal of Speaker 1 to Pin 5, and the plus terminal of Speaker 2 to Pin 8, proper speaker phase can be established.

The maximum power dissipation of the device can be found by doubling Equation 11, assuming both loads are equal. If the loads are different, use Equation 11 to find the power dissipation caused by each load, then take the sum to find the total power dissipated by the SSM2211.

Evaluation Board

An evaluation board for the SSM2211 is available. Contact your local sales representative or call 1-800-ANALOGD for more information.

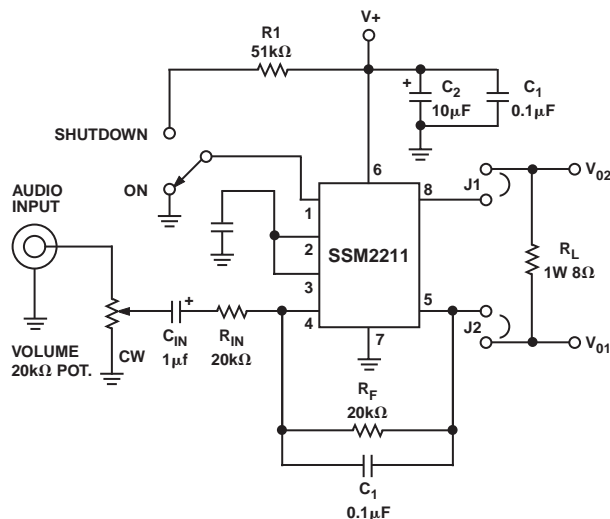

Figure 47. Evaluation Board Schematic

The voltage gain of the SSM2211 is given by Equation 20 below:

$$A_V = 2 \times \frac{R_F}{R_{IN}} \quad (20)$$

If desired, the input signal may be attenuated by turning the $10\ \text{k}\Omega$ potentiometer in the CW direction. C_{IN} isolates the input common mode voltage ($V+/2$) present at Pin 2 and 3. With $V+ = 5\ \text{V}$, there is $+2.5\ \text{V}$ common-mode voltage present at both output terminals V_{O1} and V_{O2} as well.

CAUTION: The ground lead of the oscilloscope probe, or any other instrument used to measure the output signal, must not be connected to either output, as this would short out one of the amplifier's outputs and possibly damage the device.

A safe method of displaying the differential output signal using a grounded scope is shown in Figure 48. Simply connect the Channel A probe to V_{O2} terminal post, connect the Channel B probe to V_{O1} post, invert Channel B and add the two channels together. Most multichannel oscilloscopes have this feature built in. If you

must connect the ground lead of the test instrument to either output signal pins, a power line isolation transformer must be used to isolate the instrument ground from power supply ground.

Recall that $V = \sqrt{P \times R}$, so for $P_O = 1\ \text{W}$ and $R_L = 8\ \Omega$, $V = 2.8\ \text{V rms}$, or $8\ \text{V p-p}$. If the available input signal is $1.4\ \text{V rms}$ or more, use the board as is, with $R_F = R_I = 20\ \text{k}\Omega$. If more gain is needed, increase the value of R_F to obtain the desired gain.

When you have determined the closed-loop gain required by your source level, and can develop $1\ \text{W}$ across the $8\ \Omega$ load resistor with the normal input signal level, replace the resistor with your speaker. Your speaker may be connected across the V_{O1} and V_{O2} posts for bridged mode operation only after the $8\ \Omega$ load resistor is removed. For no phase inversion, V_{O2} should be connected to the (+) terminal of the speaker.

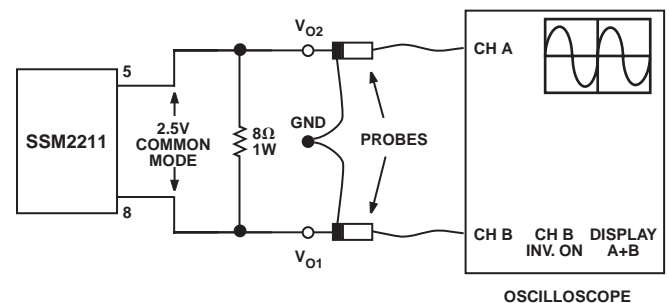

Figure 48. Using an Oscilloscope to Display the Bridged Output Voltage

To use the SSM2211 in a single ended output configuration, replace J1 and J2 jumpers with electrolytic capacitors of a suitable value, with the NEGATIVE terminals to the output terminals V_{O1} and V_{O2} . The single ended loads may then be returned to ground. Note that the maximum output power is reduced to $250\ \text{mW}$, one quarter of the rated maximum, due to the maximum swing in the non-bridged mode being one-half, and power being proportional to the square of the voltage. For frequency response down $3\ \text{dB}$ at $100\ \text{Hz}$, a $200\ \mu\text{F}$ capacitor is required with $8\ \Omega$ speakers.

The SSM2211 evaluation board also comes with a SHUTDOWN switch which allows the user to switch between ON (normal operation) and the power conserving shutdown mode.

Printed Circuit Board Layout Consideration

All surface mount packages rely on the traces of the PC board to conduct heat away from the package.

In standard packages, the dominant component of the heat resistance path is the plastic between the die attach pad and the individual leads. In typical thermally enhanced packages, one or more of the leads are fused to the die attach pad, significantly decreasing this component. To make the improvement meaningful, however, a significant copper area on the PCB must be attached to these fused pins.

The patented Thermal Coastline lead frame design used in the SSM2211 (Figure 49) uniformly minimizes the value of the dominant portion of the thermal resistance. It ensures that heat is conducted away by all pins of the package. This yields a very low, 98°C/W , thermal resistance for an SO-8 package, without any special board layer requirements, relying on the normal traces connected to the leads. The thermal resistance can be decreased by approximately an additional 10% by attaching a few

SSM2211

square cm of copper area to the ground pins. It is recommended that the solder mask and/or silk screen on the PCB traces adjacent to the SSM2211 pins be deleted, thus reducing further the junction to ambient thermal resistance of the package.

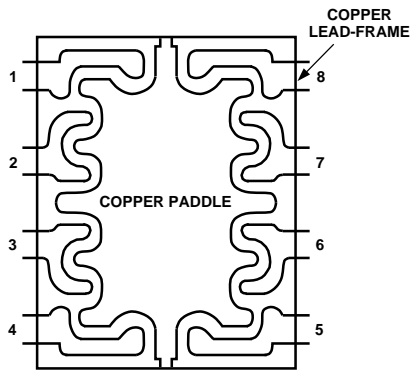
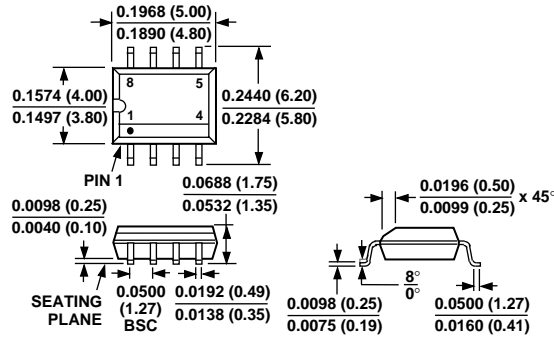

Figure 49. Thermal Coastline

OUTLINE DIMENSIONS

Dimensions shown in inches and (mm).

**8-Lead SOIC
(S0-8)**



**8-Lead Plastic DIP
(N-8)***

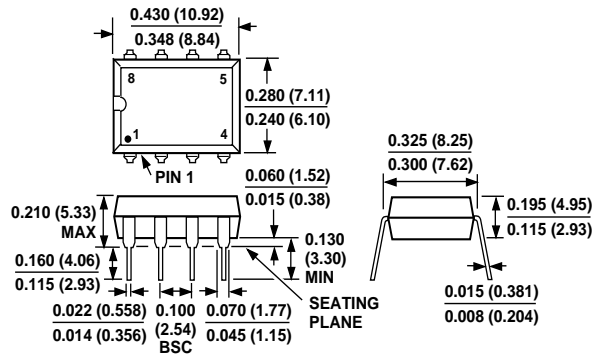

*Special order only.

