

FEATURES

- 80 μ A Supply Current
- 4V to 36V Operation
- 0.5 $^{\circ}$ C Typical Initial Accuracy
- Compatible with Standard Thermocouples (E, J, K, R, S, T)
- Auxiliary 10mV/ $^{\circ}$ C Output
- Bow Corrected

APPLICATIONS

- Thermocouple Cold Junction Compensator
- Centigrade Thermometer
- Temperature Compensation Network

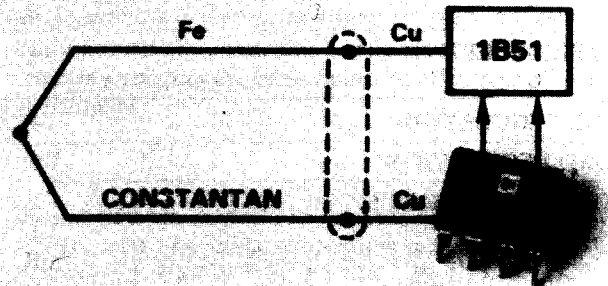

PRODUCT DESCRIPTION

The AC1226 is a micropower thermocouple cold junction compensator for use with type E, J, K, R, S and T thermocouples. It utilizes wafer level and post-package trimming to achieve typical 0.5 $^{\circ}$ C initial accuracy. Special curvature correction circuitry is used to match the "bow" found in all thermocouples so that accurate cold junction compensation is maintained over a wider temperature range.

The AC1226 will operate with a supply voltage from 4V to 36V.

Typical supply current is 80 μ A, resulting in less than 0.1 $^{\circ}$ C internal temperature rise for supply voltages under 10V. A 10mV/ $^{\circ}$ C output is available at low impedance in addition to the direct thermocouple voltages of 60.9 μ V/ $^{\circ}$ C (E), 51.7 μ V/ $^{\circ}$ C (J), 40.3 μ V/ $^{\circ}$ C (K, T) and 5.95 μ V/ $^{\circ}$ C (R, S). All outputs are essentially independent of power supply voltage.

The AC1226 is available in an 8-pin plastic miniDIP for temperatures between 0 and +70 $^{\circ}$ C.

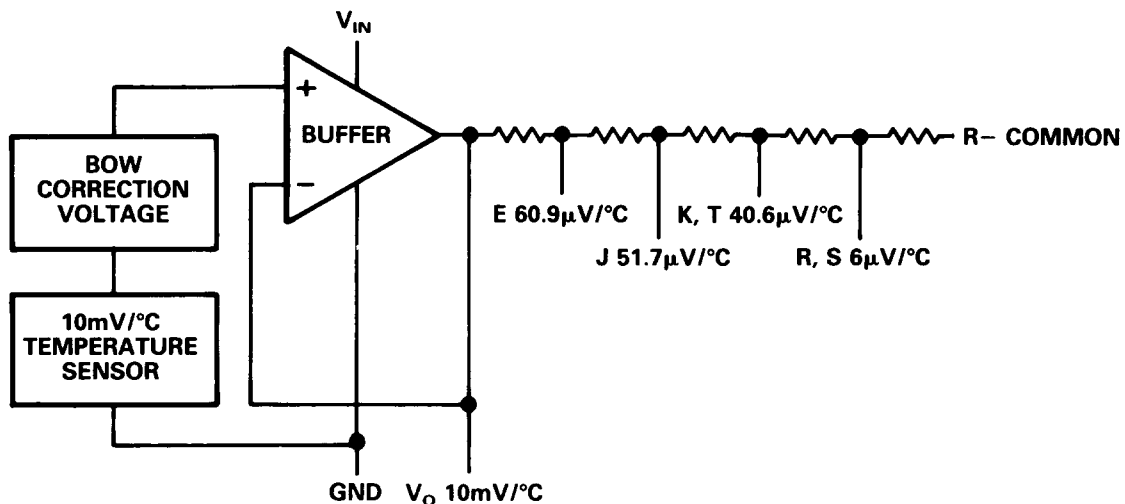

AC1226 Block Diagram

Information furnished by Analog Devices is believed to be accurate and reliable. However, no responsibility is assumed by Analog Devices for its use; nor for any infringements of patents or other rights of third parties which may result from its use. No license is granted by implication or otherwise under any patent or patent rights of Analog Devices.

One Technology Way; P.O. Box 9106; Norwood, MA 02062-9106
Tel: 617/329-4700 TWX: 710/394-6577

West Coast
714/641-9391

Central
214/231-5094

Atlantic
215/643-7790

SPECIFICATIONS

Electrical Characteristics ($V_S = 5V$, $T_A = +25^\circ C$, Pin 5 tied to Pin 4, unless otherwise noted.)

Parameter	Conditions	Min	Typ	Max	Units
TEMPERATURE ERROR AT 10mV/°C OUTPUT ^{1,2}	$T_J = +25^\circ C$ Full Temperature Span*		0.5 See Curve	2.0	°C
RESISTOR DIVIDER ACCURACY ^{1,3}	$V_{OUT} = 10mV/^\circ C$				$\mu V/^\circ C$
	E	60.4	60.9	61.6	
	J	51.2	51.7	52.3	
	K, T	40.2	40.6	41.2	
	R, S	5.75	5.95	6.3	
SUPPLY CURRENT	$4V \leq V_{IN} \leq 36V$ *	50 50	80	100 150	μA
LINE REGULATION ⁴	$4V \leq V_{IN} \leq 36V^*$		0.003	0.02	°C/V
LOAD REGULATION ⁴	$0 \leq I_O \leq 1mA^*$		0.04	0.2	°C
DIVIDER IMPEDANCE	E J K, T R, S		2.5 2.1 4.4 3.8		k Ω
CHANGE IN SUPPLY CURRENT	$4V \leq V_{IN} \leq 36V$		0.01	0.05	$\mu A/V$

PRICES

1-9	\$10
100s	\$ 7

NOTES

¹To calculate total temperature error at individual thermocouple outputs, add 10mV/°C output error to the resistor divider error. Total error for type K output at +25°C with an AC1226 is 2.0°C plus (0.6 $\mu V/^\circ C$) (25°C)/(40.6 $\mu V/^\circ C$) = 2.0°C + 0.37°C = 2.37°C.

²Temperature error is defined as the deviation from the following formula: $V_{OUT} = 10mV(T) + (10mV)(5.5 \times 10^{-4})(T - 25^\circ C)^2$. The second term is a built-in nonlinearity designed to help compensate the nonlinearity of the cold junction. This "bow" is $\approx 0.34^\circ C$ for a 25°C temperature change.

³Divider accuracy is measured by applying a 10.000V signal to the output divider and measuring the individual outputs.

⁴Regulation does not include the effects of self-heating. See "Internal Temperature Rise" in Application Guide. Load regulation is $30\mu A \leq I_O \leq 1mA$ for $T_A \leq 0^\circ C$.

*Denotes the specifications which apply over the full operating temperature range. Specifications subject to change without notice.

PIN CONFIGURATION

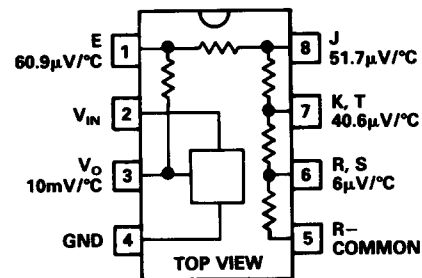

ABSOLUTE MAXIMUM RATINGS

Input Supply Voltage	.36V
Output Voltage (Forced)	.5V
Output Short Circuit Duration	Indefinite
Operating Temperature Range	0 to +70°C
Storage Temperature Range	-55°C to +150°C
Lead Temperature (Soldering, 10sec)	+300°C

Typical Performance Characteristics

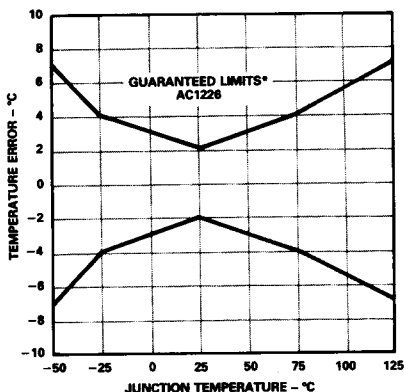

*ERROR CURVE FACTORS IN THE NONLINEARITY TERM BUILT IN TO THE AC1226 SEE THEORY OF OPERATION IN APPLICATION GUIDE SECTION.

10mV/°C Output Temperature Error

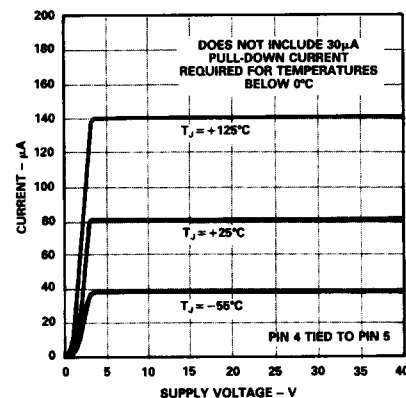

Supply Current

APPLICATION GUIDE

The AC1226 was designed to be extremely easy to use, but the following ideas and suggestions should be helpful in obtaining the best possible performance and versatility from this new cold junction compensator.

THEORY OF OPERATION

A thermocouple consists of two dissimilar metals joined together. A voltage (Seebeck EMF) will be generated if the two ends of the thermocouple are at different temperatures. In Figure 1, iron and constantan are joined at the temperature measuring point T1. Two additional thermocouple junctions are formed where the iron and constantan connect to ordinary copper wire. For the purposes of this discussion it is assumed that these two junctions are at the same temperature, T2. The Seebeck voltage, V_S , is the product of the Seebeck coefficient α , and the temperature difference, $T_1 - T_2$; $V_S = \alpha (T_1 - T_2)$. The junctions at T2 are commonly called the cold junction because a common practice is to immerse the T2 junction in 0°C ice/water slurry to make T2 independent of room temperature variations. Thermocouple tables are based on a cold junction temperature of 0°C.

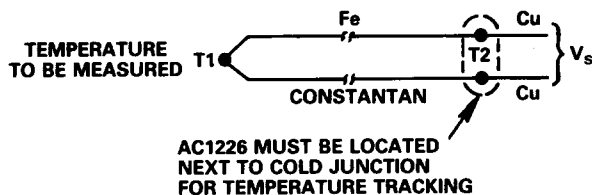

Figure 1.

For most applications an electronically simulated cold junction is required. The idea is basically to add a temperature dependent voltage to V_S such that the voltage sum is the same as if the T2 junction were at a constant 0°C instead of at room temperature. This voltage source is called a cold junction compensator. Its output is designed to be 0V at 0°C and have a slope equal to the Seebeck coefficient over the expected range of T2 temperatures.

To operate properly, a cold junction compensator must be at exactly the same temperature as the cold junction of the thermocouple (T2). Therefore, it is important to locate the AC1226 physically close to the cold junction with local temperature gradients minimized. If this is not possible, an extender made of matching thermocouple wire can be used. This shifts the cold junction from the user termination to the end of the extender so that the AC1226 can be located remotely from the user termination as shown in Figure 2.

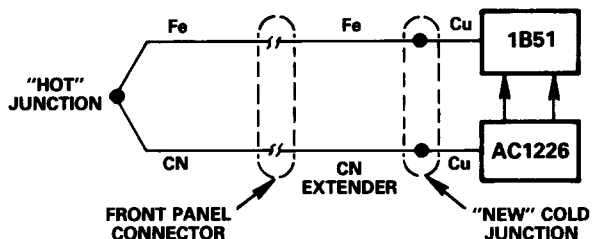

Figure 2.

The four thermocouple outputs on the AC1226 are 60.9 $\mu\text{V}/^\circ\text{C}$ (E), 51.7 $\mu\text{V}/^\circ\text{C}$ (J), 40.6 $\mu\text{V}/^\circ\text{C}$ (K and T) and 6 $\mu\text{V}/^\circ\text{C}$ (R and S). These particular coefficients are chosen to match the room temperature (+25°C) slope of the thermocouples. Over wide temperature ranges, however, the slope of thermocouples changes, yielding a quasi-parabolic error compared to a constant slope. The AC1226 outputs have a deliberate parabolic "bow" to help compensate for this effect. The outputs can be mathematically described as the sum of a linear term equal to room temperature slope plus a quadratic term proportional to temperature deviation from +25°C squared. The coefficient (β) of the quadratic term is a compromise value chosen to offer improvement in all the outputs.

$$V_{\text{OUT}} = \alpha T + \beta (T - 25^\circ\text{C})^2$$

$$\beta \approx 5.5 \times 10^{-4}$$

The actual β term which would be required to best compensate each thermocouple type in the temperature range of 0 to +50°C is: E, 6.6×10^{-4} ; J, 4.8×10^{-4} ; K, 4.3×10^{-4} ; R, 1.9×10^{-3} ; S, 1.9×10^{-3} ; T, 1×10^{-3} .

The temperature error specification for the AC1226 (shown as a graph) assumes a β of 5.5×10^{-4} . For example, an AC1226 is considered "perfect" if its 10mV/°C output fits the equation $V_O = 10\text{mV}(T) + 5.5 \times 10^{-4}(T - 25)^2$.

OPERATING AT NEGATIVE TEMPERATURES

The AC1226 is designed to operate with a single positive supply. It therefore cannot deliver proper outputs for temperatures below zero unless an external pull-down resistor is added to the V_O output. This resistor can be connected to any convenient negative supply. It should be selected to sink at least 30 μA of current. Suggested value for a -5V supply is 150k Ω , and for a -15V supply, 470k Ω . Smaller resistors must be used if an external load is connected to the 10mV/°C output. The AC1226 can source up to 1mA of current, but there is a trade-off with internal temperature rise.

INTERNAL TEMPERATURE RISE

The AC1226 is specified for temperature accuracy assuming no internal temperature rise. At low supply voltages this rise is usually negligible ($\approx 0.05^\circ\text{C}$ @ 5V), but at higher supply voltages or with external loads or pull-down current, internal rise could become significant. This effect can be calculated from a simple thermal formula, $\Delta T = (\theta_{JA}) (V^+) (I_Q + I_L)$, where θ_{JA} is thermal resistance from junction to ambient ($\approx 130^\circ\text{C}/\text{W}$), V^+ is the AC1226 supply voltage, I_Q is the AC1226 supply current ($\approx 80 \mu\text{A}$), and I_L is the total load current including actual load to ground and any pull-down current needed to generate negative outputs. A sample calculation with a 15V supply and 50 μA pull-down current would yield, $(130^\circ\text{C}/\text{W}) (15\text{V}) (80 + 50 \mu\text{A}) = 0.32^\circ\text{C}$. This is a significant rise in some applications. It can be reduced by lowering supply voltage (a simple fix is to insert a 10V Zener in the V_{IN} lead) or the system can be calibrated and specified after an initial warm-up period of several minutes.

THERMOCOUPLE EFFECTS IN LEADS

Thermocouple voltages are generated whenever dissimilar materials are joined. This includes the leads of IC packages, which may be kovar in TO-5 cans, alloy 42 or copper in dual-in-line packages, and a variety of other materials in plating finishes and solders. The net effect of these thermocouples is "zero" if all are at exactly the same temperature, but temperature gradients exist within IC packages and across PC boards whenever power is dissipated. For this reason, extreme care must be used to ensure that no temperature gradients exist in the vicinity of thermocouple terminations, the AC1226, or the thermocouple amplifier. If a gradient cannot be eliminated, leads should be positioned isothermally, especially the AC1226 R⁻ and appropriate output pins, the amplifier input pins and the gain setting resistor leads. An effect to watch for is amplifier offset voltage warm-up drift caused by mismatched thermocouple materials in the wire bond/lead system of the package. This effect can be as high as tens of microvolts in TO-5 cans with kovar leads. It has nothing to do with the actual offset drift specification of the amplifier and can occur in amplifiers with measured "zero" drift. Warm-up drift is directly proportional to amplifier power dissipation. It can be minimized by avoiding TO-5 cans, using low supply

current amplifiers and by using the lowest possible supply voltages. Finally, it can be accommodated by calibrating and specifying the system after a five minute warm-up period.

Figure 3 shows how to connect the AC1226 to the IB51 to compensate for the cold junction. This circuit is a conditioned and isolated channel for E, J, K, R, S or T thermocouples.

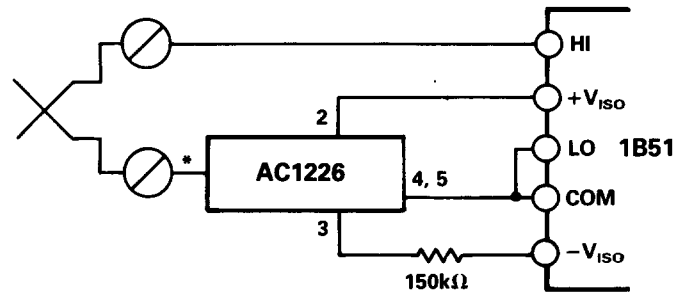

*PIN NUMBER DEPENDS ON THERMOCOUPLE TYPE.

Figure 3. Using the AC1226 with the IB51, Isolated mV/Thermocouple Signal Conditioner

MECHANICAL INFORMATION

OUTLINE DIMENSIONS

Dimensions shown in inches and (mm).

