

FEATURES

- Complete Dual 12-Bit DAC
- Pretrimmed Internal Voltage Reference
- Single +3 V Operation
- 0.5 mV/Bit with 2.0475 V Full Scale
- Low Power: 9.6 mW
- 3-Wire Serial SPI Compatible Interface
- Power Shutdown $I_{DD} < 1 \mu A$
- Compact SO-14, 1.75 mm Height Package

APPLICATIONS

- Portable Communications
- Digitally Controlled Calibration
- Servo Controls
- PC Peripherals

FUNCTIONAL BLOCK DIAGRAM

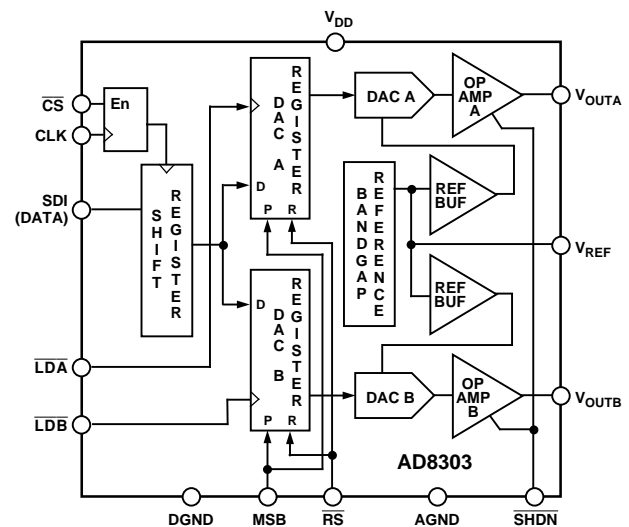

GENERAL DESCRIPTION

The AD8303 is a complete (includes internal reference) dual, 12-bit, voltage output digital-to-analog converter designed to operate from a single +3 volt supply. Built using a CBCMOS process, this monolithic DAC offers the user low cost and ease-of-use in single-supply +3 volt systems. Operation is guaranteed over the supply voltage range of +2.7 V to +5.5 V making this device ideal for battery operated applications.

The 2.0475 V full-scale voltage output is laser-trimmed to maintain accuracy over the operating temperature range of the device. The binary input data format provides an easy-to-use one-half millivolt-per-bit software programmability. The voltage outputs are capable of sourcing 3 mA.

A double buffered serial data interface offers high speed, three-wire, DSP and SPI microcontroller compatible inputs using data in (SDI), clock (CLK) and load strobe ($\overline{LDA} + \overline{LDB}$) pins. A chip-select (\overline{CS}) pin simplifies connection of multiple DAC packages by enabling the clock input when active low. Additionally, an \overline{RS} input sets the output to zero scale or to 1/2 scale based on the level applied to the MSB pin. A power shutdown feature reduces power dissipation to less than 3 μW .

The AD8303 is specified over the extended industrial ($-40^{\circ}C$ to $+85^{\circ}C$) temperature range. AD8303s are available in plastic DIP and low profile 1.75 mm height SO-14 surface mount packages. For single-channel DAC applications, see the AD8300 which is offered in the 8-lead DIP and SO-8 packages.

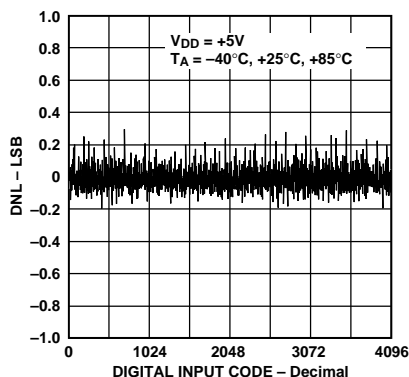

Figure 1. Differential Nonlinearity Error vs. Code

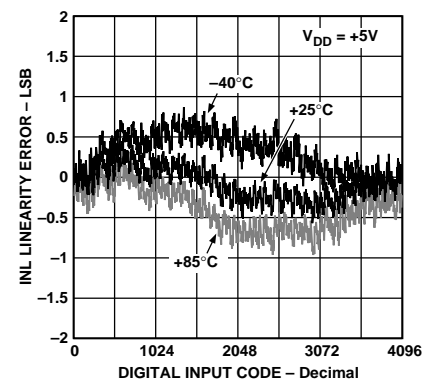

Figure 2. Linearity Error vs. Digital Code and Temperature

REV. 0

Information furnished by Analog Devices is believed to be accurate and reliable. However, no responsibility is assumed by Analog Devices for its use, nor for any infringements of patents or other rights of third parties which may result from its use. No license is granted by implication or otherwise under any patent or patent rights of Analog Devices.

© Analog Devices, Inc., 1996

One Technology Way, P.O. Box 9106, Norwood, MA 02062-9106, U.S.A.
Tel: 617/329-4700 Fax: 617/326-8703

AD8303—SPECIFICATIONS

+3 V OPERATION (@ $V_{DD} = +2.7\text{ V}$ to $+3.6\text{ V}$, $-40^{\circ}\text{C} \leq T_A \leq +85^{\circ}\text{C}$, unless otherwise noted)

Parameter	Symbol	Condition	Min	Typ ¹	Max	Units
STATIC PERFORMANCE						
Resolution ²	N		12			Bits
Relative Accuracy ²	INL		-2	±1/2	+2	LSB
Differential Nonlinearity ²	DNL	Monotonic, $T_A = +25^{\circ}\text{C}$	-3/4	±1/4	+3/4	LSB
Differential Nonlinearity ²	DNL	Monotonic	-1	±1/2	+1	LSB
Zero-Scale Error	V_{ZSE}	Data = 000 _H		1.25	+4.5	mV
Full-Scale Voltage ³	V_{FS}	Data = FFF _H ²	2.039	2.0475	2.056	Volts
Full-Scale Tempco ^{3,4}	TCV_{FS}			16		ppm/°C
ANALOG OUTPUTS						
Output Current	I_{OUT}	Data = 800 _H , $\Delta V_{OUT} < 3\text{ mV}$			±3	mA
Output Resistance to GND	R_{OUT}	Data = 000 _H		30		Ω
Capacitive Load ⁴	C_L	No Oscillation ³		500		pF
REFERENCE OUTPUT						
Output Voltage	V_{REF}	Load > 1 MΩ		1		V
LOGIC INPUTS						
Logic Input Low Voltage	V_{IL}				0.6	V
Logic Input High Voltage	V_{IH}		2.1			V
Input Leakage Current	I_{IL}				10	μA
Input Capacitance ⁴	C_{IL}				10	pF
INTERFACE TIMING SPECIFICATIONS^{4,5}						
Clock Width High	t_{CH}		40			ns
Clock Width Low	t_{CL}		40			ns
Load Pulse Width	t_{LDW}		40			ns
Data Setup	t_{DS}		15			ns
Data Hold	t_{DH}		15			ns
Reset Pulse Width	t_{RS}		40			ns
Load Setup	t_{LD1}		15			ns
Load Hold	t_{LD2}		40			ns
Select	t_{CSS}		40			ns
Deselect	t_{CSH}		40			ns
AC CHARACTERISTICS⁴						
Voltage Output Settling Time ⁶	t_S	To ±0.1% of Full Scale		4		μs
Voltage Output Settling Time ⁶	t_S	To ±1 LSB of Final Value		14		μs
Shutdown Recovery Time	t_{DSR}	To ±0.1% of Full Scale		10		μs
Output Slew Rate	SR	Data = 000 _H to FFF _H to 000 _H		2.0		V/μs
DAC Glitch	Q			15		nV/s
Digital Feedthrough	Q			15		nV/s
SUPPLY CHARACTERISTICS						
Power Supply Range	$V_{DD\text{ RANGE}}$	$DNL < \pm 1\text{ LSB}$	2.7		5.5	V
Shutdown Current	I_{DD_SD}	$\overline{SHDN} = 0$, No Load, $V_{IL} = 0\text{ V}$, $T_A = +25^{\circ}\text{C}$		0.02	1	μA
Supply Current ⁷	I_{DD}	$V_{DD} = 3\text{ V}$, $V_{IL} = 0\text{ V}$, No Load		2	3.2	mA
Power Dissipation	P_{DISS}	$V_{DD} = 3\text{ V}$, $V_{IL} = 0\text{ V}$, No Load		6	9.6	mW
Power Supply Sensitivity	PSS	$\Delta V_{DD} = \pm 5\%$		0.001	0.004	%/%

NOTES

¹Typical readings represent the average value of room temperature operation.

²1 LSB = 0.5 mV for 0 V to +2.0475 V output range. The first two codes (000_H, 001_H) are excluded from the linearity error measurement.

³Includes internal voltage reference error.

⁴These parameters are guaranteed by design and not subject to production testing.

⁵All input control signals are specified with $t_R = t_F = 2\text{ ns}$ (10% to 90% of +3 V) and timed from a voltage level of 1.6 V.

⁶The settling time specification does not apply for negative going transitions within the last 6 LSBs of ground.

⁷See Figure 6 for a plot of incremental supply current consumption as a function of the digital input voltage levels.

Specifications subject to change without notice.

SPECIFICATIONS

AD8303

+5 V OPERATION (@ $V_{DD} = +5 V \pm 10\%$, $-40^{\circ}\text{C} \leq T_A \leq +85^{\circ}\text{C}$, unless otherwise noted)

Parameter	Symbol	Condition	Min	Typ ¹	Max	Units
STATIC PERFORMANCE						
Resolution ²	N		12			Bits
Relative Accuracy ²	INL		-2	±1/2	+2	LSB
Differential Nonlinearity ²	DNL	Monotonic, $T_A = +25^{\circ}\text{C}$	-3/4	±1/4	+3/4	LSB
Differential Nonlinearity ²	DNL	Monotonic	-1	±1/2	+1	LSB
Zero-Scale Error	V_{ZSE}	Data = 000 _H		1.25	+4.5	mV
Full-Scale Voltage ³	V_{FS}	Data = FFF _H	2.039	2.0475	2.056	Volts
Full-Scale Tempco ^{3, 4}	TCV_{FS}			16		ppm/°C
ANALOG OUTPUTS						
Output Current	I_{OUT}	Data = 800 _H , $\Delta V_{OUT} < 3 \text{ mV}$			±3	mA
Output Resistance to GND	R_{OUT}	Data = 000 _H		30		Ω
Capacitive Load ⁴	C_L	No Oscillation		500		pF
REFERENCE OUTPUT						
Output Voltage	V_{REF}	Load > 1 MΩ		1		V
LOGIC INPUTS						
Logic Input Low Voltage	V_{IL}				0.8	V
Logic Input High Voltage	V_{IH}		2.4			V
Input Leakage Current	I_{IL}				10	μA
Input Capacitance ⁴	C_{IL}				10	pF
INTERFACE TIMING SPECIFICATIONS^{4, 5}						
Clock Width High	t_{CH}		30			ns
Clock Width Low	t_{CL}		30			ns
Load Pulse Width	t_{LDW}		30			ns
Data Setup	t_{DS}		15			ns
Data Hold	t_{DH}		15			ns
Reset Pulse Width	t_{RS}		30			ns
Load Setup	t_{LD1}		15			ns
Load Hold	t_{LD2}		30			ns
Select	t_{CSS}		30			ns
Deselect	t_{CSH}		30			ns
AC CHARACTERISTICS⁴						
Voltage Output Settling Time ⁶	t_S	To ±0.1% of Full Scale		4		μs
Voltage Output Settling Time ⁶	t_S	To ±1 LSB of Final Value ⁵		12		μs
Shutdown Recovery Time	t_{SDR}	To ±0.1% of Full Scale		10		μs
Output Slew Rate	SR	Data = 000 _H to FFF _H to 000 _H		2		V/μs
DAC Glitch	Q			15		nV s
Digital Feedthrough	Q			15		nV s
SUPPLY CHARACTERISTICS						
Power Supply Range	$V_{DD \text{ RANGE}}$	$DNL < \pm 1 \text{ LSB}$	2.7	3.0	5.5	V
Shutdown Supply Current	$I_{DD \text{ SD}}$	$\overline{\text{SHDN}} = 0$, No Load, $V_{IL} = 0 \text{ V}$, $T_A = +25^{\circ}\text{C}$		0.02	1	μA
Positive Supply Current ⁷	I_{DD}	$V_{DD} = 5 \text{ V}$, $V_{IL} = 0 \text{ V}$, No Load		2.1	3.4	mA
Power Dissipation	P_{DISS}	$V_{DD} = 5 \text{ V}$, $V_{IL} = 0 \text{ V}$, No Load		10.5	17	mW
Power Supply Sensitivity	PSS	$\Delta V_{DD} = \pm 10\%$		0.001	0.004	%/%

NOTES

¹Typical readings represent the average value of room temperature operation.

²1 LSB = 0.5 mV for 0 V to +2.0475 V output range. The first two codes (000_H, 001_H) are excluded from the linearity error measurement.

³Includes internal voltage reference error.

⁴These parameters are guaranteed by design and not subject to production testing.

⁵All input control signals are specified with $t_R = t_F = 2 \text{ ns}$ (10% to 90% of +5 V) and timed from a voltage level of 1.6 V.

⁶The settling time specification does not apply for negative going transitions within the last 6 LSBs of ground.

⁷See Figure 6 for a plot of incremental supply current consumption as a function of the digital input voltage levels.

Specifications subject to change without notice.

AD8303

ABSOLUTE MAXIMUM RATINGS*

V_{DD} to GND-0.3 V, +8 V
Logic Inputs to GND-0.3 V, +8 V
V_{OUT} to GND-0.3 V, $V_{DD} + 0.3$ V
I_{OUT} Short Circuit to GND 50 mA
Package Power Dissipation $(T_{JMAX} - T_A) / \theta_{JA}$
Thermal Resistance θ_{JA}	
14-Pin Plastic DIP Package (N-14) 103°C/W
14-Lead SOIC Package (R-14) 158°C/W
Maximum Junction Temperature (T_{JMAX}) 150°C
Operating Temperature Range -40°C to +85°C
Storage Temperature Range -65°C to +150°C
Lead Temperature (Soldering, 10 secs) +300°C

*Stress above those listed under “Absolute Maximum Ratings” may cause permanent damage to the device. This is a stress rating only and functional operation of the device at these or any other conditions above those indicated in the operational sections of this specification is not implied. Exposure to absolute maximum rating conditions for extended periods may affect device reliability.

ORDERING GUIDE

Model	DNL	Temperature Range	Package Description	Package Option
AD8303AN	± 0.75	-40°C to +85°C	14-Pin P-DIP	N-14
AD8303AR	± 0.75	-40°C to +85°C	14-Lead SOIC	R-14

The AD8303 contains 700 transistors. The die size measures 70 mil \times 99 mil.

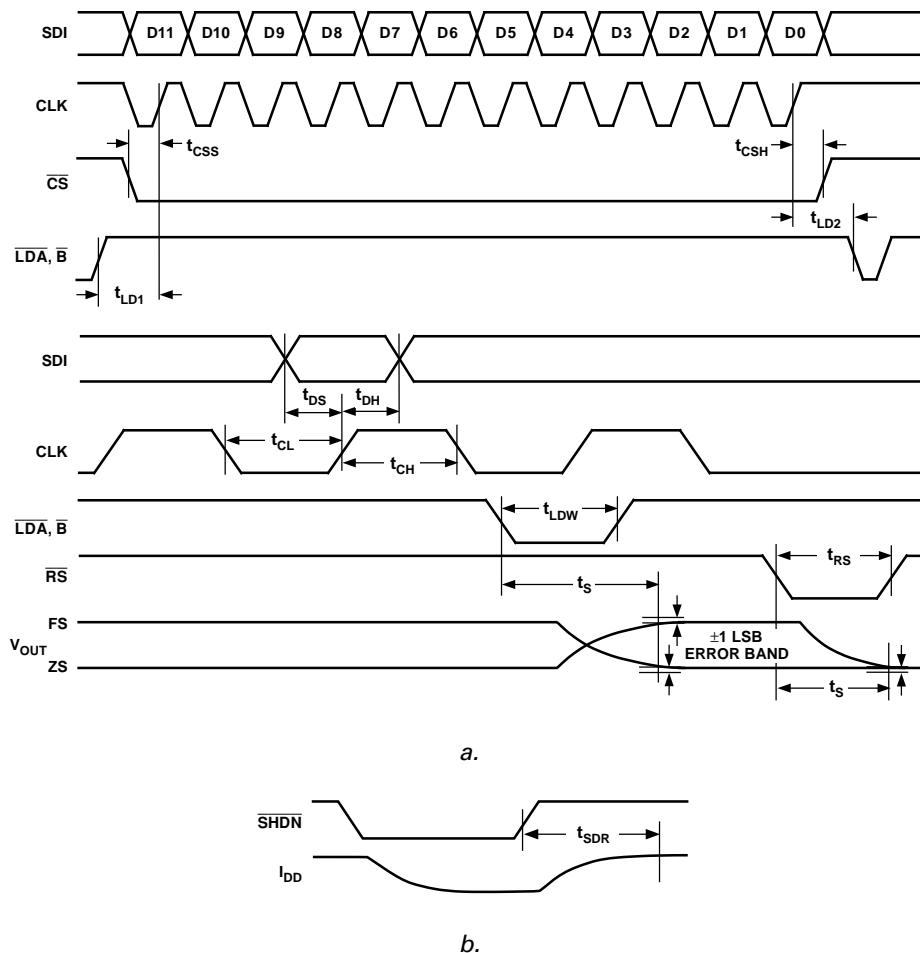

Figure 3. Timing Diagrams

CAUTION

ESD (electrostatic discharge) sensitive device. Electrostatic charges as high as 4000 V readily accumulate on the human body and test equipment and can discharge without detection. Although the AD8303 features proprietary ESD protection circuitry, permanent damage may occur on devices subjected to high energy electrostatic discharges. Therefore, proper ESD precautions are recommended to avoid performance degradation or loss of functionality.



Table I. Control-Logic Truth Table

\overline{CS}	CLK	\overline{RS}	MSB	\overline{SHDN}	$\overline{LDA/B}$	Serial Shift Register Function	DAC Register Function
H	X	H	X	H	H	No Effect	Latched
L	L	H	X	H	H	No Effect	Latched
L	H	H	X	H	H	No Effect	Latched
L	$\uparrow+$	H	X	H	H	Shift-Register-Data Advanced One Bit	Latched
$\uparrow+$	L	H	X	H	H	No Effect	Latched
H	X	H	X	H	$\downarrow-$	No Effect	Updated with Current Shift Register Contents
H	X	H	X	H	L	No Effect	Transparent
X	X	L	H	H	X	No Effect	Loaded with 800 _H
X	X	$\uparrow+$	H	H	H	No Effect	Latched with 800 _H
X	X	L	L	H	X	No Effect	Loaded with All Zeros
X	X	$\uparrow+$	X	H	H	No Effect	Latched All Zeros
X	X	X	X	L	X	No Effect	No Effect

NOTES

¹ $\uparrow+$ positive logic transition; $\downarrow-$ negative logic transition; X Don't Care.

²Do not clock in serial data while \overline{LDA} or \overline{LDB} is LOW.

PIN DESCRIPTIONS

Pin No.	Name	Function
1	AGND	Analog Ground.
2	V _{OUTA}	DAC voltage output, 2.0475 V full scale with 0.5 mV per bit. An internal temperature stabilized reference maintains a fixed full-scale voltage independent of time, temperature and power supply variations.
3	V _{REF}	Reference Voltage Output Terminal. Very high output resistance must be buffered if used as a virtual ground.
4	DGND	Digital Ground
5	\overline{CS}	Chip Select, Active Low Input. Disables shift register loading when high. Does not effect \overline{LDA} or \overline{LDB} operation.
6	CLK	Clock Input, positive edge clocks data into shift register.
7	SDI	Serial Data Input, input data loads directly into the shift register.
8	\overline{LDA}	Load DAC register strobes, active low. Transfers shift register data to DAC A register. Asynchronous active low input. See Control Logic Truth Table for operation.
9	\overline{RS}	Resets DAC register to zero condition or half-scale depending on MSB pin. Asynchronous active low input.
10	\overline{LDB}	Load DAC register strobes, active low. Transfers shift register data to DAC B register. Asynchronous active low input. See Control Logic Truth Table for operation.
11	MSB	Digital Input: Logic High presets DAC registers to half-scale 800 _H (sets MSB bit to one) when the \overline{RS} pin is strobed; Logic Low clears all DAC registers to zero (000 _H) when the \overline{RS} pin is strobed.
12	\overline{SHDN}	Active low shutdown control input. Does not affect register contents as long as power is present on V _{DD} .
13	V _{DD}	Positive power supply input. Specified range of operation +2.7 V to +5.5 V
14	V _{OUTB}	DAC voltage output, 2.0475 V full scale with 0.5 mV per bit. An internal temperature stabilized reference maintains a fixed full-scale voltage independent of time, temperature and power supply variations.

PIN CONFIGURATION

14-Pin P-DIP (N-14)

14-Lead SOIC (R-14)

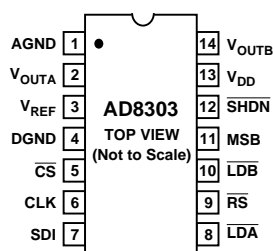

AD8303—Typical Performance Characteristics

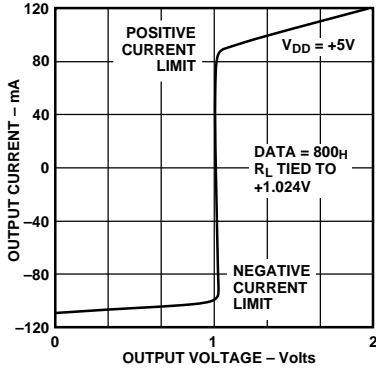

Figure 4. I_{OUT} vs. V_{OUT}

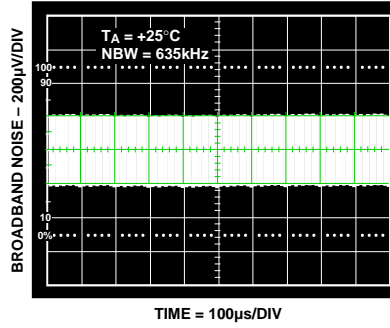

Figure 5. Broadband Noise

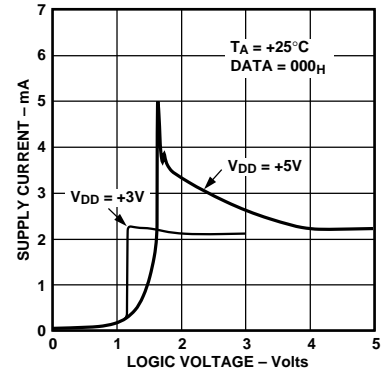

Figure 6. Supply Current vs. Logic Input Voltage

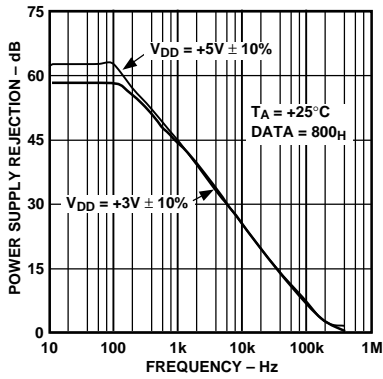

Figure 7. Power Supply Rejection vs. Frequency

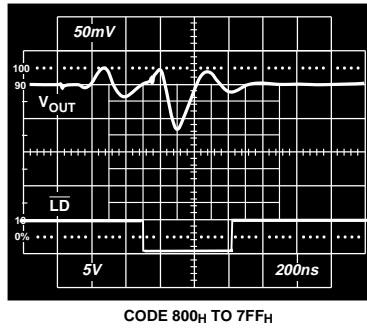

Figure 8. Midscale Transition Performance

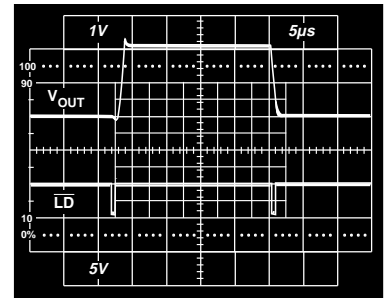

Figure 9. Large Signal Settling Time

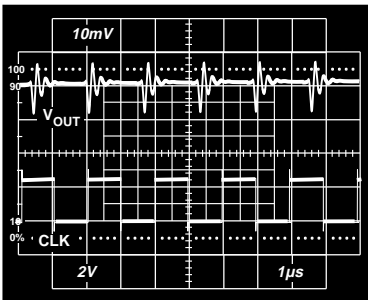

Figure 10. Clock Feedthrough vs. Time

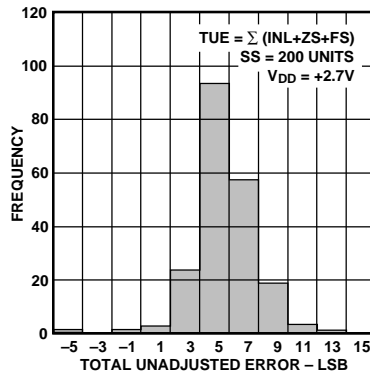

Figure 11. Total Unadjusted Error Histogram

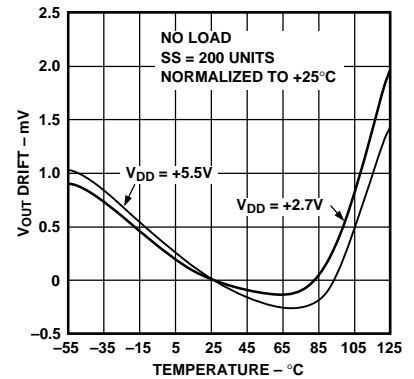

Figure 12. Full-Scale Voltage Drift vs. Temperature

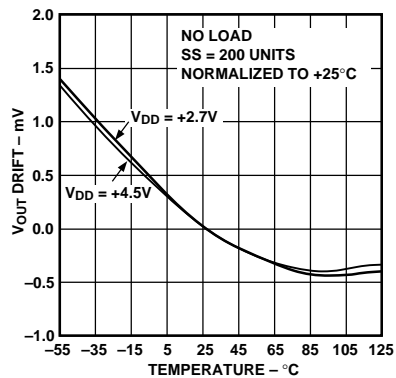

Figure 13. Zero-Scale Voltage Drift vs. Temperature

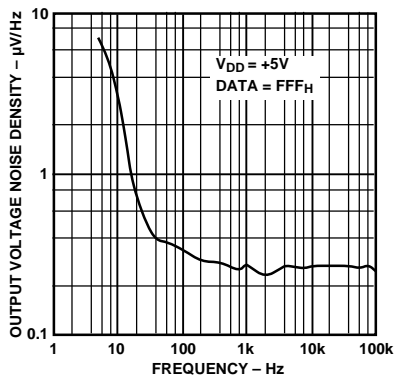

Figure 14. Output Voltage Noise Density vs. Frequency

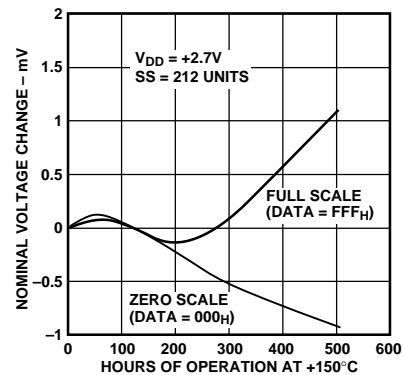

Figure 15. Long-Term Drift Accelerated by Burn-In

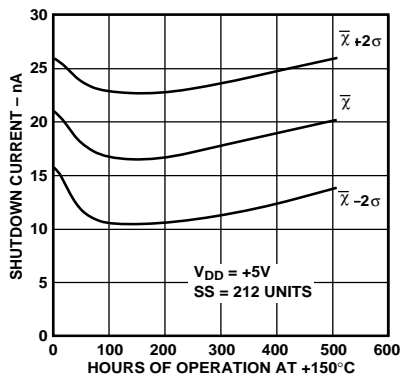

Figure 16. Shutdown Current vs. Time Accelerated by Burn-In

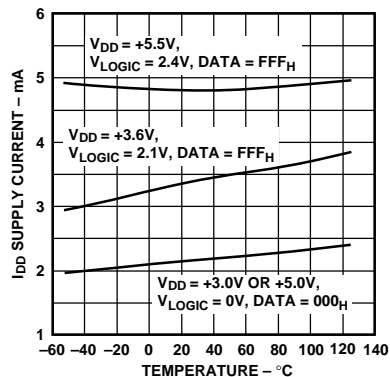

Figure 17. Supply Current vs. Temperature

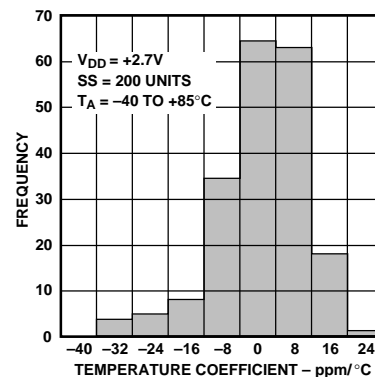

Figure 18. Full-Scale Output Tempco Histogram

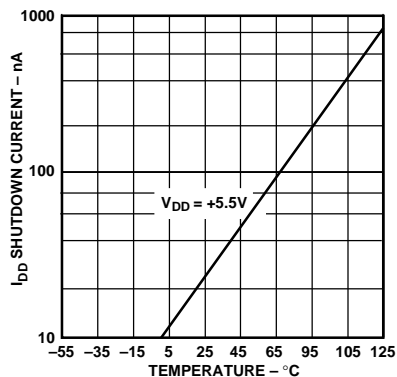

Figure 19. Shutdown Current vs. Temperature

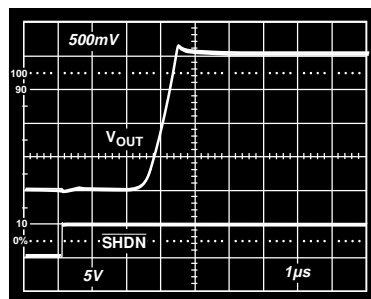

Figure 20. Shutdown Recovery Time

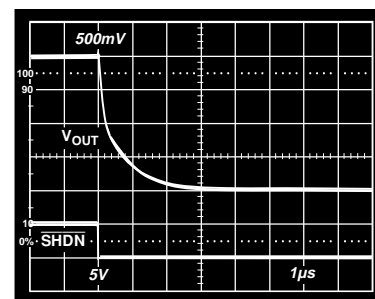

Figure 21. Shutdown Time

AD8303

THEORY OF OPERATION

The AD8303 is a complete, ready-to-use, dual, 12-bit digital-to-analog converter. Only one +2.7 V to +5.5 V power supply is necessary for operation. It contains two voltage-switched, 12-bit, laser-trimmed digital-to-analog converters, a curvature-corrected bandgap reference, rail-to-rail output op amps, input shift register, and two DAC registers. The serial data interface consists of a serial data input (SDI), clock (CLK), chip select ($\overline{\text{CS}}$) and two DAC load strobe pins ($\overline{\text{LDA}}$ and $\overline{\text{LDB}}$).

For battery operation and similar low power applications, a shutdown feature (SHDN) is available to reduce power supply current to less than 1 μA . In addition an asynchronous reset pin ($\overline{\text{RS}}$) will set both DAC outputs to either zero volts or to midscale, depending on the logic value applied to the MSB pin. This function is useful for power-on reset or system failure recovery to a known state.

D/A CONVERTER SECTION

Each of the two DACs is a 12-bit device with an output that swings from GND potential to 0.4 V generated from the internal bandgap voltage (Figure 22). Each DAC uses a laser-trimmed segmented R-2R ladder that is switched by n-channel MOSFETs. The output voltage of the DAC has a constant resistance independent of digital input code. The DAC output is internally connected to the rail-to-rail output op amp.

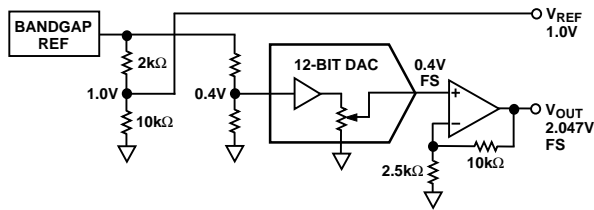

Figure 22. AD8303 Equivalent Schematic of Analog Section

AMPLIFIER SECTION

The internal DAC's output is buffered by a low power consumption, precision amplifier. This low power amplifier contains a differential PNP pair input stage that provides low offset voltage and low noise, as well as the ability to amplify the zero-scale DAC output voltages. The rail-to-rail amplifier is configured with a gain of approximately five in order to set the 2.0475 volt full-scale output (0.5 mV/LSB). An equivalent circuit schematic for the amplifier section is shown in Figure 22.

The op amp has a 4 μs typical settling time to 0.1% of full scale. There are slight differences in settling time for negative slewing signals versus positive. Also, negative transition settling time to within the last 6 LSBs of zero volts has an extended settling time. See the oscilloscope photos in the typical performances section of this data sheet.

OUTPUT SECTION

The rail-to-rail output stage of this amplifier has been designed to provide precision performance while operating near either power supply. Figure 23 shows an equivalent output schematic of the rail-to-rail amplifier with its N-channel pull-down FETs that will pull an output load directly to GND. The output sourcing current is provided by a P-channel pull-up device that can source current to GND terminated loads.

The rail-to-rail output stage permits operation at supply voltages down to +2.7 V. The N-channel output pull-down MOSFET shown in Figure 23 has a 35 Ω ON resistance which sets the sink current capability near ground. In addition to resistive load driving capability, the amplifier has also been carefully designed and characterized for up to 500 pF capacitive load driving capability.

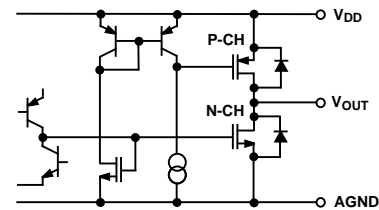

Figure 23. Equivalent Analog Output Circuit

REFERENCE SECTION

The internal curvature-corrected bandgap voltage reference is laser trimmed for both initial accuracy and low temperature coefficient. Figure 18 provides a histogram of total output performance of full-scale versus temperature, which is dominated by the reference performance.

V_{REF} Output

The internal reference drives two resistor-divider networks. One divider provides a 0.4 V reference for the DAC. The second divider is trimmed to 1.0 V and is available at the V_{REF} pin. The V_{REF} output is useful for ratiometric applications, and also for generating a “false ground” or bipolar offset. See Figures 30 and Figure 31 for typical applications. Since V_{REF} has a high output impedance, it must be buffered if it is required to deliver current to an external load.

POWER SUPPLY

The very low power consumption of the AD8303 is a direct result of a circuit design optimizing the use of a CBCMOS process. By using the low power characteristics of CMOS for the logic, and the low noise, tight matching of the complementary bipolar transistors, excellent analog accuracy is achieved.

One advantage of the rail-to-rail output amplifiers used in the AD8303 is the wide range of usable supply voltage. The part is fully specified and tested for operation from +2.7 V to +5.5 V. If reduced linearity and source current capability near full scale can be tolerated, operation of the AD8303 is possible down to +2.7 V.

POWER SUPPLY BYPASSING AND GROUNDING

Precision analog products, such as the AD8303, require a well filtered power source. Since the AD8303 operates from a single +3 V to +5 V supply, it seems convenient to simply tap into the digital logic power supply. Unfortunately, the logic supply is often a switch-mode design, which generates noise in the 20 kHz to 1 MHz range. In addition, fast logic gates can generate glitches hundred of millivolts in amplitude due to wiring resistances and inductances. The power supply noise generated thereby means that special care must be taken to insure that the inherent precision of the DAC is maintained. Good engineering judgment should be exercised when addressing the power supply grounding and bypassing of the AD8303.

The AD8303 should be powered directly from the system power supply. This arrangement, shown in Figure 24, employs an LC filter and separate power and ground connections to isolate the analog section from the logic switching transients. Analog and digital ground pins of the AD8303 should be connected together directly at the IC package.

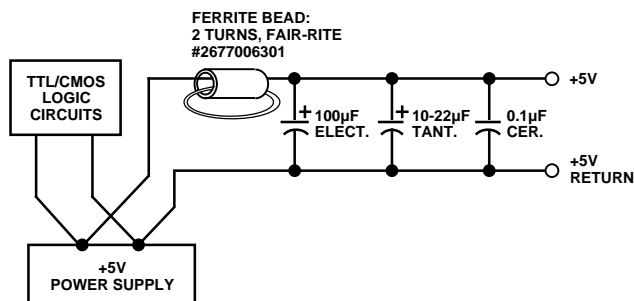

Figure 24. Use Separate Traces to Reduce Power Supply Noise

Whether or not a separate power supply trace is available, however, generous supply bypassing will reduce supply-line induced errors. Local supply bypassing consisting of a 10 µF tantalum electrolytic in parallel with a 0.1 µF ceramic capacitor is recommended in all applications (Figure 25).

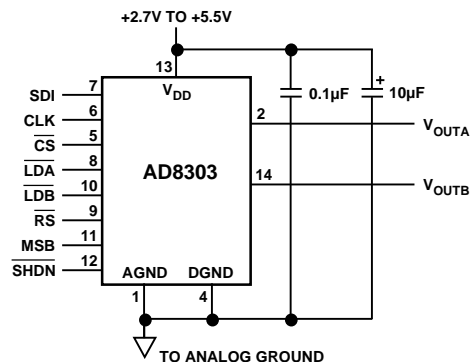

Figure 25. Recommended Supply Bypassing for the AD8303

INPUT LOGIC LEVELS

All digital inputs are protected with a Zener-type ESD protection structure (Figure 26) that allows logic input voltages to exceed the V_{DD} supply voltage. This feature can be useful if the user is driving one or more of the digital inputs with a 5 V CMOS logic input voltage level while operating the AD8303 on a +3 V power supply. If this mode of interface is used, make sure that the V_{OL} of the 5 V CMOS meets the V_{IL} input requirement of the AD8303 operating at 3 V. See Figure 6 for a graph for digital logic input threshold versus operating V_{DD} supply voltage.

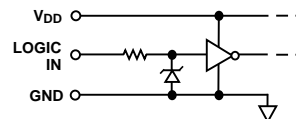

Figure 26. Equivalent Digital Input ESD Protection

For power consumption-sensitive applications, it is important to note that the internal power consumption of the AD8303 is strongly dependent on the actual logic input voltage levels present in the SDI, CLK, CS, LDA, LDB, SHDN, RS and MSB pins. Since these inputs are standard CMOS logic structures, they contribute static power dissipation which depends on the actual driving logic V_{OH} and V_{OL} voltage levels. Consequently, using CMOS logic versus TTL will provide minimal dissipation in the static state.

AD8303

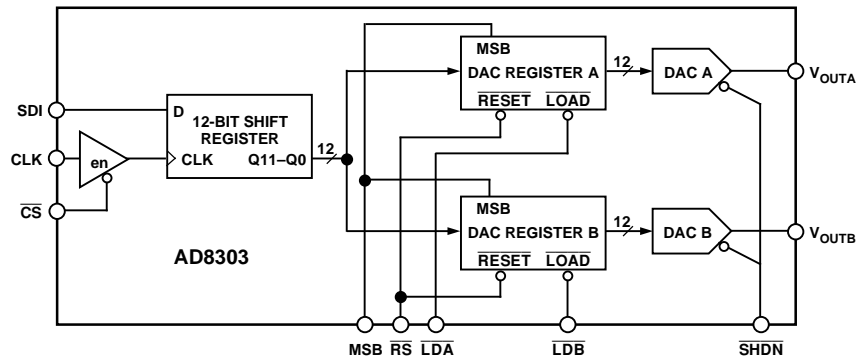

Figure 27. AD8303 Digital Section Functional Block Diagram

DIGITAL INTERFACE

The AD8303 has a double-buffered serial data input. The serial-input register is separate from the two DAC registers, which allows preloading of a new data value into the serial register without disturbing the present DAC values. A functional block diagram of the digital section is shown in Figure 27, while Table I contains the truth table for the control logic inputs.

Three pins control the serial data input. Data at the Serial Data Input (SDI) is clocked into the shift register on the rising edge of CLK. Data is entered in MSB-first format. Twelve clock pulses are required to load the 12-bit DAC value. If additional bits are clocked into the shift register, for example when a μC sends two 8-bit bytes, the MSBs are ignored (Figure 28). The CLK pin is only enabled when Chip Select ($\overline{\text{CS}}$) is low. If only one AD8303 is connected to a serial data bus, then $\overline{\text{CS}}$ can be tied (hardwired) to ground.

BYTE 1									BYTE 2								
MSB								LSB	MSB								LSB
B15	B14	B13	B12	B11	B10	B9	B8	B7	B6	B5	B4	B3	B2	B1	B0		
X	X	X	X	D11	D10	D9	D8	D7	D6	D5	D4	D3	D2	D1	D0		

D11–D0: 12-BIT DAC VALUE

X = DON'T CARE

THE MSB OF BYTE 1 IS THE FIRST BIT THAT IS LOADED INTO THE DAC

Figure 28. Typical AD8303-Microprocessor Serial Data Input Format

Separate Load pins ($\overline{\text{LDA}}$ and $\overline{\text{LDB}}$) are provided to control the flow of data from the shift register to the DAC registers. After the new value is loaded in the serial-input register, it can be asynchronously transferred to either DAC register by strobing the appropriate Load pin ($\overline{\text{LDA}}$ or $\overline{\text{LDB}}$). The Load pins are level sensitive, so they should be returned high before any new data is loaded into the serial-input register.

RESET ($\overline{\text{RS}}$) AND MSB PINS

The $\overline{\text{RS}}$ pin forces both of the DAC registers to a known state, based on the logic level on the MSB pin. If MSB is a logic zero, then forcing $\overline{\text{RS}}$ low will set the DAC latches to all zeros and the DAC output voltage will be zero volts. If MSB is a logic one, then $\overline{\text{RS}}$ will force the DAC latches to one-half scale (800_{H}) and the DAC outputs will be 1.024 V. The half-scale reset is useful for systems where the DAC output is referenced to a “false ground” (see the Generating Bipolar Outputs with a Single Supply section of this data sheet for more information).

The reset function is useful for setting the DAC outputs to zero at power-up or after a power supply interruption. Test systems and motor controllers are two of many applications which benefit from powering up to a known state. The reset pulse can be generated by the microprocessor’s power-on RESET signal, by an output from the microprocessor (Figure 33), or by an external resistor and capacitor (Figure 34).

$\overline{\text{RS}}$ and MSB have level-sensitive thresholds. The $\overline{\text{RS}}$ input overrides other logic inputs (specifically, $\overline{\text{LDA}}$ and $\overline{\text{LDB}}$). However, $\overline{\text{LDA}}$ and $\overline{\text{LDB}}$ should be set high before $\overline{\text{RS}}$ goes high. If $\overline{\text{LDA}}$ or $\overline{\text{LDB}}$ are kept low, then the contents of the shift register will be transferred to the DAC register as soon as $\overline{\text{RS}}$ goes high.

SHUTDOWN ($\overline{\text{SHDN}}$)

The shutdown feature is activated when $\overline{\text{SHDN}}$ is pulled low. While the AD8303 is in shutdown mode, the voltage reference, DACs, and output amplifiers are all turned off. Supply current is less than 1 μA . The DAC output voltage goes to 0 V, pulled to GND by the 12.5 k Ω feedback resistors (Figure 22).

If power (i.e., V_{DD}) is maintained to the AD8303 during shutdown, the value stored in the DAC input latches will not change. When the $\overline{\text{SHDN}}$ pin is driven high, the DACs will return to the same voltages as before shutdown. The CMOS logic section of the AD8303 remains active while $\overline{\text{SHDN}}$ is low. Thus, new data can be loaded while the DACs are shut down and, when $\overline{\text{SHDN}}$ goes high, the DACs will assume the new output voltage. The AD8303 recovers from shutdown very quickly. The voltage output settling time after shutdown is typically only a few microseconds longer than the normal settling time (Figure 20).

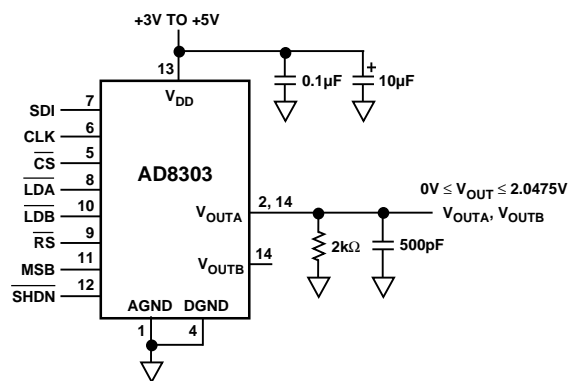

Figure 29. Unipolar Output Operation

UNIPOLAR OUTPUT OPERATION

This is the basic mode of operation for the AD8303. As shown in Figure 29, the AD8303 has been designed to drive loads as low as 2 k Ω in parallel with 500 pF. The code table for this operation is shown in Table II.

Table II. Unipolar Code Table

Hexadecimal Number in DAC Register	Decimal Number in DAC Register	Analog Output Voltage (V)
FFF	4095	2.0475
801	2049	1.0245
800	2048	1.024
7FF	2047	1.0235
000	0	0

GENERATING “BIPOLAR” OUTPUTS WITH A SINGLE SUPPLY

To maximize output signal swings in single supply operation, many circuit designs employ a “false-ground” configuration. This method defines a voltage, usually at one half of full scale or at one half of the power supply, as the “ground” reference. Signals are then measured differentially from the false ground, which produces a “quasi-bipolar” output swing.

The AD8303’s voltage reference output, combined with an op amp, can provide a temperature compensated false-ground reference, as shown in Figure 30. The op amp amplifies the AD8303’s 1.0 V reference by 1.024 to provide an analog common (false ground) at one-half scale (1.024 V). With this method, the DAC output is ± 1.024 V (referenced to the false ground). The “Quasi-Bipolar” code table is given in Table III.

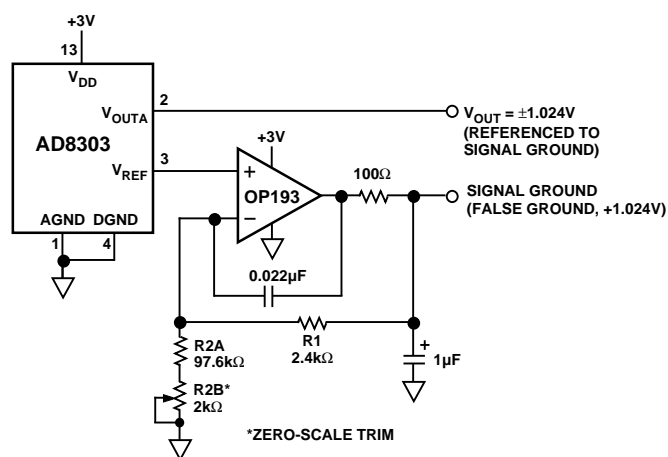

Figure 30. A False-Ground Generator

Table III. Quasi-Bipolar Code Table

Hexadecimal Number in DAC Register	Decimal Number In DAC Register	DAC Output Voltage (V)	Analog Common (False-Ground) Voltage (V)	“Bipolar” Analog Voltage (V)
FFF	4095	2.0475	1.024	+1.2035
801	2049	1.0245	1.024	0.0005
800	2048	1.024	1.024	0
7FF	2047	1.0235	1.024	-0.0005
000	0	0	1.024	-1.024

Since the AD8303’s reference voltage output limits are typical, a trim potentiometer is included so that the “false-ground” output can be adjusted to exactly 1.024 V. To maintain accuracy, resistors R1 and R2A must be of the same type (preferably metal film) to insure temperature coefficient matching. The circuit includes compensation to allow for a 1 μF bypass capacitor at the false-ground output. The benefit of a large capacitor is that not only does the false ground present a very low dc resistance to the load, but its ac impedance is low as well.

AD8303

BIPOLAR OUTPUT OPERATION

Although the AD8303 has been designed for single-supply operation, the output can also be configured for bipolar operation. A typical circuit is shown in Figure 31. This circuit uses the AD8303's internal voltage reference to generate a bipolar offset. Since V_{REF} must source current in this application, one half of an OP293 dual op amp is used as a buffer. The other op amp then amplifies the DAC output voltage to produce a bipolar output swing. The output voltage is coded in offset binary and is given by:

$$V_O = 0.5 \text{ mV} \times \text{Digital Code} \times \left(\frac{R_4}{R_3 + R_4} \right) \times \left(1 + \frac{R_2}{R_1} \right) - 1.0 \text{ V} \times \frac{R_2}{R_1}$$

where 0.5 mV represents the pretrimmed value for one LSB of the AD8303, Digital Code is the digital code sent to the DAC, and 1.0 V is the AD8303 reference voltage.

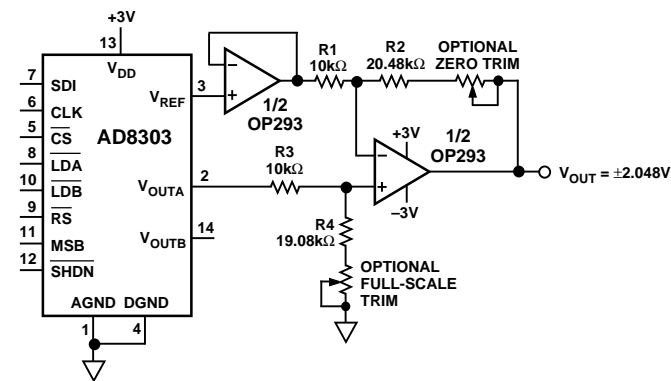

Figure 31. Bipolar Output Operation

For a $\pm 2.048 \text{ V}$ full scale using the circuit values shown, the transfer function becomes:

$$V_O = 1 \text{ mV} \times \text{Digital Code} - 2.048 \text{ V}$$

Note that the full-scale span has increased from 2.048 V to 4.096 V ($\pm 2.048 \text{ V}$). Therefore, although each AD8303 LSB represents 0.5 mV, each output LSB of the bipolar circuit has been scaled to 1 mV. The code table for this circuit is shown in Table IV.

Table IV. Bipolar Code Table

Hexadecimal Number in DAC Register	Decimal Number in DAC Register	Analog Output Voltage (V)
FFF	4095	2.047
801	2049	0.001
800	2048	0
7FF	2047	-0.001
000	0	-2.048

As with the false-ground generator circuit, resistor matching is

important to maintain accuracy. Resistor pairs R1-R2 and R3-R4 should be selected to match within 0.01%. In addition, these resistors must be of the same type (preferably metal film) to insure temperature coefficient matching. Mismatching between R1 and R2 causes offset and gain errors while an R3 to R4 mismatch yields gain errors.

GENERATING A NEGATIVE SUPPLY VOLTAGE

Some applications may require a bipolar output configuration, as shown in Figure 31, but only have a single power supply rail available. This is very common in data acquisition systems using microprocessor-based systems. In these systems, +12 V, +15 V, and/or +5 V only are available. Single supply rails are, of course, common in battery-powered systems. Shown in Figure 32 is a method of generating a negative supply using a single IC and two capacitors. The ADM8660 employs a charge pump technique to invert supply voltages as low as 1.5 V. A shutdown feature on the ADM8660 complements the shutdown of the AD8303. Note, however, that the ADM8660 requires about 500 μs to turn on after exiting the shutdown state.

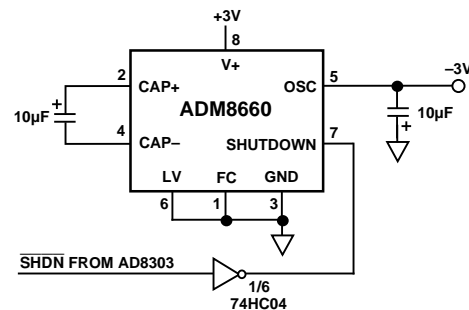

Figure 32. Generating a Negative Supply Voltage

MICROCOMPUTER INTERFACES

The AD8303 serial data input provides an easy interface to a variety of single-chip microcomputers (μCs). Many μCs have a built-in serial data capability which can be used for communicating with the DAC. In cases where no serial port is provided, or it is being used for some other purpose (such as an RS-232 communications interface), the AD8303 can easily be addressed in software.

Twelve data bits are required to load a value into the AD8303. If more than 12 bits are transmitted before the Chip Select input goes high, the extra (i.e., the most significant) bits are ignored. This feature is valuable because most μCs only transmit data in 8-bit increments. Thus, the μC sends 16 bits to the DAC instead of 12 bits. The AD8303 will only respond to the last 12 bits clocked into the SDI input, however, so the serial data interface is not affected.

AD8303-MC68HC11 INTERFACE

The circuit illustrated in Figure 33 shows a serial interface between the AD8303 and the MC68HC11 8-bit micro-processor. The MOSI output drives the AD8303's serial data input, SDI, while SCK drives the clock (CLK). The DAC's \overline{CS} , \overline{LDA} , \overline{LDB} , MSB and \overline{RS} inputs are driven by lines PD5 and PC0-PC3, respectively.

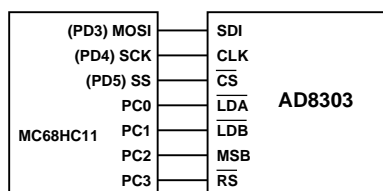

NOTE: ADDITIONAL PINS OMITTED FOR CLARITY

Figure 33. AD8303-MC68HC11 Serial Interface

To load data into the AD8303, the 68HC11's CPOL and CPHA bits are set high. This action configures the μC to transfer data on the rising edge of the serial clock. After \overline{CS} is set low, two bytes of data are sent to the AD8303 using the format shown in Figure 28. Then \overline{LDA} or \overline{LDB} are strobed low, transferring the serial-input register contents to the appropriate DAC. The \overline{RS} and MSB inputs allow the DAC to be reset to either zero volts or half scale at any time.

AN 8051 μC INTERFACE

A typical interface between the AD8303 and an 8051 μC is shown in Figure 34. This interface also uses the μC 's internal serial port. The serial port is programmed for Mode 0 operation, which functions as a simple 8-bit shift register. The 8051's Port 3.0 pin functions as the serial data output, while Port 3.1 serves as the serial clock. The \overline{LDA} and \overline{LDB} pins are controlled by the 8051's Port 1.0 and Port 1.1 lines, respectively.

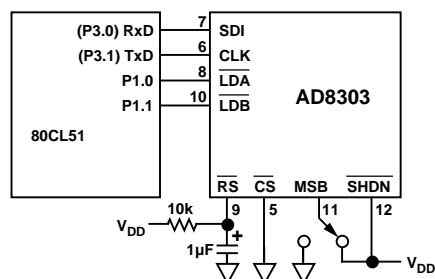

NOTE: ADDITIONAL PINS OMITTED FOR CLARITY

Figure 34. AD8303-80CL51 Serial Interface

The 8051's serial data transmission is straightforward. When data is written to the serial buffer register (SBUF, at Special Function Register location 99H), the data is automatically converted to serial format and clocked out via Port 3.0 and Port 3.1. After 8 bits have been transmitted, the Transmit Interrupt flag (SCON.1) is set and the next 8 bits can be transmitted.

The circuit of Figure 34 demonstrates "hardwiring" many of the AD8303 features which may not have to be changed within a given design. For example, the reset feature is controlled by a resistor and capacitor. This produces a power-on reset pulse without requiring a μC I/O pin. The MSB pin can be hardwired to V_{DD} or ground, depending on whether a reset to 0 V or half scale is required. If the AD8303 is the only device on the serial interface, \overline{CS} can also be tied to ground. Finally, \overline{SHDN} can be tied to V_{DD} if the shutdown feature will not be used.

Software for the interface of Figure 34 is shown in Figure 35. This routine sends the 12-bit value placed in registers DAC_VAL0 and DAC_VAL1 to the DAC addressed by the two LSBs of DAC_ADDR.

The subroutine begins by setting appropriate bits in the Serial Control register to configure the serial port for Mode 0 operation. The MSBs of the DAC value are obtained from memory location DAC_VAL1, adjusted to compensate for the 8051's serial data format, and moved to the serial buffer register. At this point, serial data transmission begins automatically. When all 8 bits have been sent, the Transmit Interrupt bit is set, and the subroutine then proceeds to send the LSBs of the DAC value, stored at location DAC_VAL0. Next the \overline{LDA} and \overline{LDB} bits from DAC_ADDR are logically ANDed with Port1. This action sets the appropriate AD8303 DAC select input low and transfers the DAC value from the serial-input register to the DAC register, causing the DAC output voltage to change. Finally the \overline{LDA} and \overline{LDB} inputs are driven high to await the next DAC update.

The 8051 sends data out of its shift register LSB first, while the AD8303 requires data MSB first. The subroutine therefore includes a BYTESWAP subroutine to reformat the data. This routine transfers the MSB-first byte at location SHIFTRREG to an LSB-first byte at location SENDBYTE. The routine rotates the MSB of the first byte into the carry with a Rotate Left Carry instruction, then rotates the carry into the MSB of the second byte with a Rotate Right Carry instruction. After 8 loops, SENDBYTE contains the data in the proper format. The BYTESWAP routine in Listing C is convenient because the DAC data can be calculated in normal LSB form.

AD8303

```
;AD8303.ASM
;
; This subroutine loads an AD8303 shift register with a 12-bit
; DAC value, and transfers the value to DAC A or DAC B.
; The DAC value is stored at location DAC_VAL1 (MSB) and DAC_VAL0 (LSB)
; The DAC address (A or B) is stored at DAC_ADDR, (b0=0 for A, b1=0 for B)
;
; Primary controls
$MOD51
$TITLE(AD8303 Interface, Using the Serial Port in Mode 0)
;
; Variable declarations
;
PORT1      DATA    90H          ;SFR register for port 1
DAC_VAL0   DATA    40H          ;LSBs of 12-bit DAC Value
DAC_VAL1   DATA    41H          ; MSBs of DAC Value
DAC_ADDR   DATA    42H          ;DAC address, format is:
                                       ; 1,1,1,1,1,1,LDB,LDA
                                       ; Set bit low to select DAC

LOOPCOUNT DATA    43H          ;Count loops for byte swap
SHIFTREG   DATA    44H          ;Shift reg. for byte swap
SENDBYTE   DATA    45H          ; Destination reg. for SR
;
DO_8303:   ORG      100H          ;arbitrary starting address
           CLR      SCON.7        ;set serial
           CLR      SCON.6        ; data mode 0
           CLR      SCON.5        ;Clr SM2 for mode 0
           CLR      SCON.1        ;Clr the transmit flag
           MOV      SHIFTREG,DAC_VAL1 ;Get Most Significant Byte
           ACALL    SEND_IT        ; send to AD8303
           MOV      SHIFTREG,DAC_VAL0 ;Get Least Significant Byte
           ACALL    SEND_IT        ; send it to the AD8303
           MOV      A,PORT1        ;Get I/O port contents
           ANL      A,DAC_ADDR     ;Clr LDA/LDB, other bits unchanged
           MOV      PORT1,A        ;Send to I/O port
           ORL      A,#00000011B   ;Set LDA and LDB high
           MOV      PORT1,A        ;Send to I/O port
           RET                    ;Done
;
           ;Convert the byte to LSB-first format and send it to the AD8303
SEND_IT:   MOV      LOOPCOUNT,#8  ;Shift 8 bits
BYTESWAP: MOV      A,SHIFTREG      ;Get source byte
           RLC      A              ;rotate MSB to carry
           MOV      SHIFTREG,A     ;Save new source byte
           MOV      A,SENDBYTE     ;get destination byte
           RRC      A              ;Move carry into MSB
           MOV      SENDBYTE,A     ;Save
           DJNZ    LOOPCOUNT,BYTESWAP ;Done?
           MOV      SBUF,SENDBYTE  ;Send the byte
SEND_WAIT: JNB     SCON.1,SEND_WAIT ;Wait until 8 bits are send
           CLR      SCON.1        ;Clear the serial flag
           RET                    ;Done
END
```

Figure 35. Software Listing for the AD8303-80CL51 Interface

OUTLINE DIMENSIONS

Dimensions shown in inches and (mm).

14-Lead Epoxy DIP (N-14)

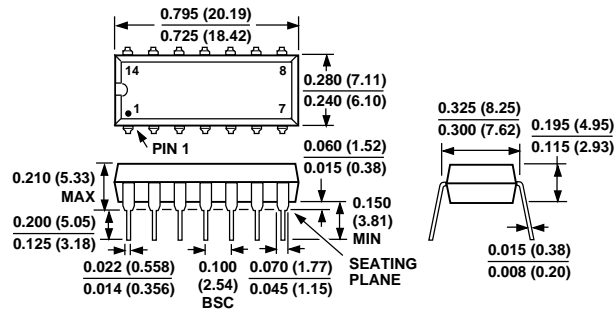

14-Lead Narrow Body SOIC (R-14)

