

ADG619/ADG620
FEATURES

6 Ω (Max) On Resistance
0.8 Ω (Max) On-Resistance Flatness
2.7 V to 5.5 V Single Supply
 ± 2.7 V to ± 5.5 V Dual Supply
Rail-to-Rail Operation
8-Lead SOT-23 Package, 8-Lead Micro-SOIC Package
Typical Power Consumption (<0.1 μ W)
TTL/CMOS Compatible Inputs

APPLICATIONS

Automatic Test Equipment
Power Routing
Communication Systems
Data Acquisition Systems
Sample and Hold Systems
Avionics
Relay Replacement
Battery-Powered Systems

GENERAL DESCRIPTION

The ADG619 and the ADG620 are monolithic, CMOS SPDT (single pole, double throw) switches. Each switch conducts equally well in both directions when on.

The ADG619/ADG620 offers low On-Resistance of 4 Ω , which is matched to within 0.7 Ω between channels. These switches also provide low power dissipation yet give high switching speeds. The ADG619 exhibits break-before-make switching action, thus preventing momentary shorting when switching channels. The ADG620 exhibits make-before-break action.

The ADG619/ADG620 are available in 8-lead SOT-23 packages and 8-lead Micro-SOIC packages.

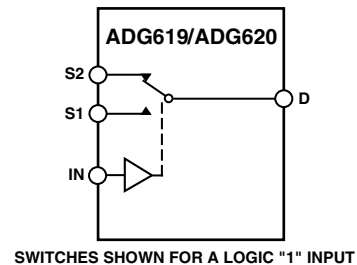
FUNCTIONAL BLOCK DIAGRAM

Table I. Truth Table for the ADG619/ADG620

IN	Switch S1	Switch S2
0	ON	OFF
1	OFF	ON

PRODUCT HIGHLIGHTS

1. Low On Resistance (R_{ON}) (4 Ω typ)
2. Dual ± 2.7 V to ± 5.5 V or Single 2.7 V to 5.5 V
3. Low Power Dissipation. CMOS construction ensures low power dissipation.
4. Fast t_{ON}/t_{OFF}
5. Tiny 8-Lead SOT-23 Package and 8-Lead Micro-SOIC Package

REV. 0

Information furnished by Analog Devices is believed to be accurate and reliable. However, no responsibility is assumed by Analog Devices for its use, nor for any infringements of patents or other rights of third parties that may result from its use. No license is granted by implication or otherwise under any patent or patent rights of Analog Devices.

ADG619/ADG620—SPECIFICATIONS

DUAL SUPPLY¹ ($V_{DD} = +5\text{ V} \pm 10\%$, $V_{SS} = -5\text{ V} \pm 10\%$, $GND = 0\text{ V}$. All specifications -40°C to $+85^{\circ}\text{C}$ unless otherwise noted.)

Parameter	B Version -40°C to +85°C		Unit	Test Conditions/Comments
	+25°C			
ANALOG SWITCH				
Analogue Signal Range		V_{SS} to V_{DD}	V	$V_{DD} = +4.5\text{ V}$, $V_{SS} = -4.5\text{ V}$
On Resistance (R_{ON})	4 6	8	Ω typ Ω max	$V_S = \pm 4.5\text{ V}$, $I_S = -10\text{ mA}$, Test Circuit 1
On Resistance Match Between Channels (ΔR_{ON})	0.7 1.1	1.35	Ω typ Ω max	$V_S = \pm 4.5\text{ V}$, $I_S = -10\text{ mA}$
On-Resistance Flatness ($R_{FLAT(ON)}$)	0.7	0.8 1.2	Ω typ Ω max	$V_S = \pm 3.3\text{ V}$, $I_S = -10\text{ mA}$
LEAKAGE CURRENTS				
Source OFF Leakage I_S (OFF)	± 0.01 ± 0.25	± 1	nA typ nA max	$V_{DD} = +5.5\text{ V}$, $V_{SS} = -5.5\text{ V}$ $V_S = \pm 4.5\text{ V}$, $V_D = \mp 4.5\text{ V}$, Test Circuit 2
Channel ON Leakage I_D , I_S (ON)	± 0.01 ± 0.25	± 1	nA typ nA max	$V_S = V_D = \pm 4.5\text{ V}$, Test Circuit 3
DIGITAL INPUTS				
Input High Voltage, V_{INH}		2.4	V min	
Input Low Voltage, V_{INL}		0.8	V max	
Input Current I_{INL} or I_{INH}	0.005	± 0.1	μA typ μA max	$V_{IN} = V_{INL}$ or V_{INH}
C_{IN} , Digital Input Capacitance	2		pF typ	
DYNAMIC CHARACTERISTICS²				
ADG619				
t_{ON}	80 120	155	ns typ ns max	$R_L = 300\ \Omega$, $C_L = 35\text{ pF}$ $V_S = 3.3\text{ V}$, Test Circuit 4
t_{OFF}	45 75	90	ns typ ns max	$R_L = 300\ \Omega$, $C_L = 35\text{ pF}$ $V_S = 3.3\text{ V}$, Test Circuit 4
Break-Before-Make Time Delay, t_{BBM}	40	10	ns typ ns min	$R_L = 300\ \Omega$, $C_L = 35\text{ pF}$ $V_{S1} = V_{S2} = 3.3\text{ V}$, Test Circuit 5
ADG620				
t_{ON}	40 65	85	ns typ ns max	$R_L = 300\ \Omega$, $C_L = 35\text{ pF}$ $V_S = 3.3\text{ V}$, Test Circuit 4
t_{OFF}	200 330	400	ns typ ns max	$R_L = 300\ \Omega$, $C_L = 35\text{ pF}$ $V_S = 3.3\text{ V}$, Test Circuit 4
Make-Before-Break Time Delay, t_{MBB}	160	10	ns typ ns min	$R_L = 300\ \Omega$, $C_L = 35\text{ pF}$ $V_S = 0\text{ V}$, Test Circuit 6
Charge Injection	110		pC typ	$V_S = 0\text{ V}$, $R_S = 0\ \Omega$, $C_L = 1\text{ nF}$, Test Circuit 7
Off Isolation	-67		dB typ	$R_L = 50\ \Omega$, $C_L = 5\text{ pF}$, $f = 1\text{ MHz}$, Test Circuit 8
Channel-to-Channel Crosstalk	-67		dB typ	$R_L = 50\ \Omega$, $C_L = 5\text{ pF}$, $f = 1\text{ MHz}$, Test Circuit 10
Bandwidth -3 dB	190		MHz typ	$R_L = 50\ \Omega$, $C_L = 5\text{ pF}$, Test Circuit 9
C_S (OFF)	25		pF typ	$f = 1\text{ MHz}$
C_D , C_S (ON)	95		pF typ	$f = 1\text{ MHz}$
POWER REQUIREMENTS				
I_{DD}	0.001	1.0	μA typ μA max	$V_{DD} = +5.5\text{ V}$, $V_{SS} = -5.5\text{ V}$ Digital Inputs = 0 V or 5.5 V
I_{SS}	0.001	1.0	μA typ μA max	Digital Inputs = 0 V or 5.5 V

NOTES

¹Temperature ranges are as follows: B Version, -40°C to $+85^{\circ}\text{C}$.

²Guaranteed by design, not subject to production test.

Specifications subject to change without notice.

SINGLE SUPPLY¹ ($V_{DD} = +5\text{ V} \pm 10\%$, $V_{SS} = 0\text{ V}$, $GND = 0\text{ V}$. All specifications -40°C to $+85^{\circ}\text{C}$ unless otherwise noted.)

Parameter	B Version		Unit	Test Conditions/Comments
	+25°C	-40°C to +85°C		
ANALOG SWITCH				
Analog Signal Range		0 V to V_{DD}	V	$V_{DD} = 4.5\text{ V}$, $V_{SS} = 0\text{ V}$
On Resistance (R_{ON})	7		Ω typ	$V_S = 0\text{ V}$ to 4.5 V, $I_S = -10\text{ mA}$, Test Circuit 1
	$\beta 10$	12.5	Ω max	
On Resistance Match Between Channels (ΔR_{ON})	0.8		Ω typ	$V_S = 0\text{ V}$ to 4.5 V, $I_S = -10\text{ mA}$
	1	1.2	Ω max	
On-Resistance Flatness ($R_{FLAT(ON)}$)	0.5	0.5	Ω typ	$V_S = 1.5\text{ V}$ to 3.3 V, $I_S = -10\text{ mA}$
		0.8	Ω max	
LEAKAGE CURRENTS				
Source OFF Leakage I_S (OFF)	± 0.01		nA typ	$V_{DD} = 5.5\text{ V}$ $V_S = 1\text{ V}/4.5\text{ V}$, $V_D = 4.5\text{ V}/1\text{ V}$, Test Circuit 2
	± 0.25	± 1	nA max	
Channel ON Leakage I_D , I_S (ON)	± 0.01		nA typ	$V_S = V_D = 1\text{ V}/4.5\text{ V}$, Test Circuit 3
	± 0.25	± 1	nA max	
DIGITAL INPUTS				
Input High Voltage, V_{INH}		2.4	V min	
Input Low Voltage, V_{INL}		0.8	V max	
Input Current I_{INL} or I_{INH}	0.005		μA typ	$V_{IN} = V_{INL}$ or V_{INH}
		± 0.1	μA max	
C_{IN} , Digital Input Capacitance	2		pF typ	
DYNAMIC CHARACTERISTICS²				
ADG619				
t_{ON}	120		ns typ	$R_L = 300\ \Omega$, $C_L = 35\text{ pF}$
	220	280	ns max	$V_S = 3.3\text{ V}$, Test Circuit 4
t_{OFF}	50		ns typ	$R_L = 300\ \Omega$, $C_L = 35\text{ pF}$
	75	110	ns max	$V_S = 3.3\text{ V}$, Test Circuit 4
Break-Before-Make Time Delay, t_{BBM}	70		ns typ	$R_L = 300\ \Omega$, $C_L = 35\text{ pF}$, $V_{S1} = V_{S2} = 3.3\text{ V}$, Test Circuit 5
		10	ns min	
ADG620				
t_{ON}	50		ns typ	$R_L = 300\ \Omega$, $C_L = 35\text{ pF}$
	85	110	ns max	$V_S = 3.3\text{ V}$, Test Circuit 4
t_{OFF}	210		ns typ	$R_L = 300\ \Omega$, $C_L = 35\text{ pF}$
	340	420	ns max	$V_S = 3.3\text{ V}$, Test Circuit 4
Make-Before-Break Time Delay, t_{MBB}	170		ns typ	$R_L = 300\ \Omega$, $C_L = 35\text{ pF}$
		10	ns min	$V_S = 3.3\text{ V}$, Test Circuit 6
Charge Injection	6		pC typ	$V_S = 0\text{ V}$, $R_S = 0\ \Omega$, $C_L = 1\text{ nF}$, Test Circuit 7
Off Isolation	-67		dB typ	$R_L = 50\ \Omega$, $C_L = 5\text{ pF}$, $f = 1\text{ MHz}$, Test Circuit 8
Channel-to-Channel Crosstalk	-67		dB typ	$R_L = 50\ \Omega$, $C_L = 5\text{ pF}$, $f = 1\text{ MHz}$, Test Circuit 10
Bandwidth -3 dB	190		MHz typ	$R_L = 50\ \Omega$, $C_L = 5\text{ pF}$, Test Circuit 9
C_S (OFF)	25		pF typ	$f = 1\text{ MHz}$
C_D , C_S (ON)	95		pF typ	$f = 1\text{ MHz}$
POWER REQUIREMENTS				
I_{DD}	0.001		μA typ	$V_{DD} = 5.5\text{ V}$ Digital Inputs = 0 V or 5.5 V
		1.0	μA max	

NOTES

¹Temperature ranges are as follows: B Version, -40°C to $+85^{\circ}\text{C}$.²Guaranteed by design, not subject to production test.

Specifications subject to change without notice.

ADG619/ADG620

ABSOLUTE MAXIMUM RATINGS¹

(T_A = 25°C unless otherwise noted)

V _{DD} to V _{SS}	13 V
V _{DD} to GND	-0.3 V to +6.5 V
V _{SS} to GND	+0.3 V to -6.5 V
Analog Inputs ²	V _{SS} -0.3 V to V _{DD} +0.3 V
Digital Inputs ²	-0.3 V to V _{DD} +0.3 V or 30 mA, Whichever Occurs First
Peak Current, S or D	100 mA (Pulsed at 1 ms, 10% Duty Cycle max)
Continuous Current, S or D	50 mA
Operating Temperature Range	
Industrial (B Version)	-40°C to +85°C
Storage Temperature Range	-65°C to +150°C
Junction Temperature	150°C
Micro-SOIC Package	
θ _{JA} Thermal Impedance	206°C/W
θ _{JC} Thermal Impedance	44°C/W
SOT-23 Package	
θ _{JA} Thermal Impedance	229.6°C/W
θ _{JC} Thermal Impedance	91.99°C/W
Lead Temperature, Soldering (10 seconds)	300°C
IR Reflow, Peak Temperature	220°C

NOTES

¹Stresses above those listed under Absolute Maximum Ratings may cause permanent damage to the device. This is a stress rating only; functional operation of the device at these or any other conditions above those listed in the operational sections of this specification is not implied. Exposure to absolute maximum rating conditions for extended periods may affect device reliability. Only one absolute maximum rating may be applied at any one time.

²Overvoltages at IN, S or D will be clamped by internal diodes. Current should be limited to the maximum ratings given.

PIN CONFIGURATIONS

8-Lead SOT-23 (RT-8)

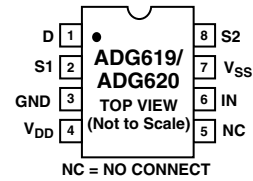

8-Lead Micro-SOIC (RM-8)

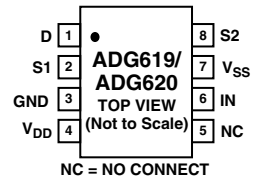

ORDERING GUIDE

Model	Temperature Range	Branding Information*	Package Description	Package Option
ADG619BRM	-40°C to +85°C	SVB	Micro-SOIC (microSmall Outline IC)	RM-8
ADG619BRT	-40°C to +85°C	SVB	SOT-23 (Plastic Surface Mount)	RT-8
ADG620BRM	-40°C to +85°C	SWB	Micro-SOIC (microSmall Outline IC)	RM-8
ADG620BRT	-40°C to +85°C	SWB	SOT-23 (Plastic Surface Mount)	RT-8

*Branding on SOT-23 and Micro-SOIC packages is limited to three characters due to space constraints.

CAUTION

ESD (electrostatic discharge) sensitive device. Electrostatic charges as high as 4000 V readily accumulate on the human body and test equipment and can discharge without detection. Although the ADG619/ADG620 features proprietary ESD protection circuitry, permanent damage may occur on devices subjected to high-energy electrostatic discharges. Therefore, proper ESD precautions are recommended to avoid performance degradation or loss of functionality.



TERMINOLOGY

Mnemonic	Description
V_{DD}	Most Positive Power Supply Potential
V_{SS}	Most Negative Power Supply in a Dual Supply Application. In single supply applications, this should be tied to ground at the device.
GND	Ground (0 V) Reference
I_{DD}	Positive Supply Current
I_{SS}	Negative Supply Current
S	Source Terminal. May be an input or output.
D	Drain Terminal. May be an input or output.
IN	Logic Control Input
R_{ON}	Ohmic Resistance Between D and S
DR_{ON}	On Resistance Match Between Any Two Channels, i.e., $R_{ON} \text{ Max} - R_{ON} \text{ Min}$.
$R_{FLAT(ON)}$	Flatness is Defined as the Difference Between the Maximum and Minimum Value of On Resistance as Measured Over the Specified Analog Signal Range.
I_S (OFF)	Source Leakage Current With the Switch "OFF"
I_D, I_S (ON)	Channel Leakage Current With the Switch "ON"
V_D (V_S)	Analog Voltage on Terminals D, S
V_{INL}	Maximum Input Voltage for Logic "0"
V_{INH}	Minimum Input Voltage for Logic "1"
I_{INL} (I_{INH})	Input Current of the Digital Input
C_S (OFF)	"OFF" Switch Source Capacitance
C_D, C_S (ON)	"ON" Switch Capacitance
t_{ON}	Delay Between Applying the Digital Control Input and the Output Switching On
t_{OFF}	Delay Between Applying the Digital Control Input and the Output Switching Off
t_{MBS}	"ON" Time, Measured Between the 80% Points of Both Switches, When Switching From One Address State to Another
t_{BBS}	"OFF" Time or "ON" Time Measured Between the 90% Points of Both Switches, When Switching from One Address State to Another
Charge Injection	A Measure of the Glitch Impulse Transferred From the Digital Input to the Analog Output During Switching
Crosstalk	A Measure of Unwanted Signal that is Coupled Through From One Channel to Another as a Result of Parasitic Capacitance
Off Isolation	A Measure of Unwanted Signal Coupling Through an "OFF" Switch
Bandwidth	The Frequency Response of the "ON" Switch
Insertion Loss	The Loss Due to the ON Resistance of the Switch

Typical Performance Characteristics

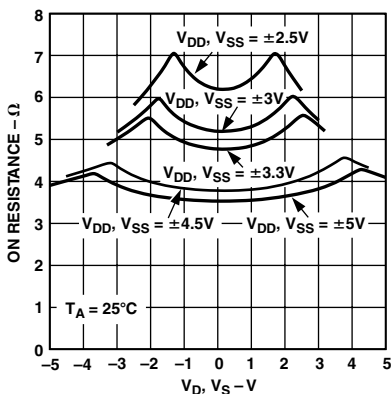

TPC 1. On Resistance vs. V_D (V_S) – Dual Supply

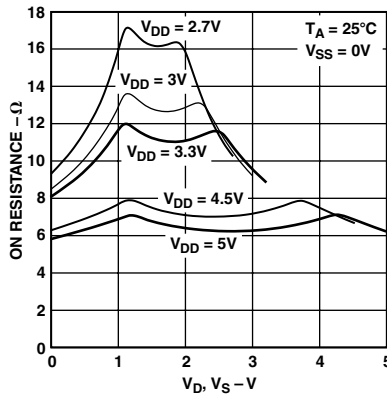

TPC 2. On Resistance vs. V_D (V_S) – Single Supply

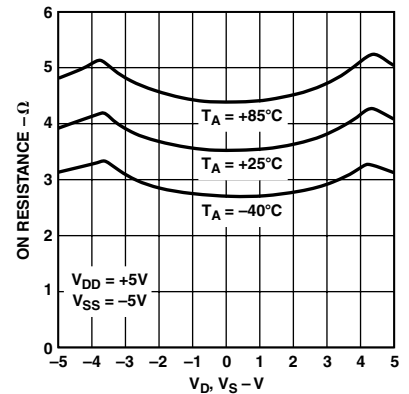

TPC 3. On Resistance vs. V_D (V_S) for Different Temperatures – Dual Supply

ADG619/ADG620—Typical Performance Characteristics

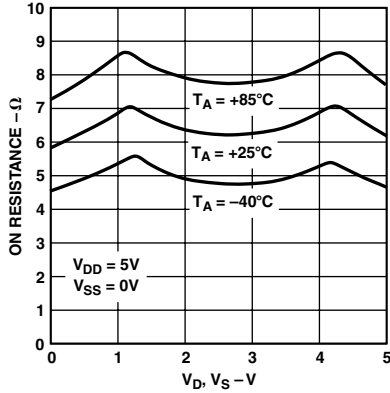

TPC 4. On Resistance vs. V_D (V_S) for Different Temperatures – Single Supply

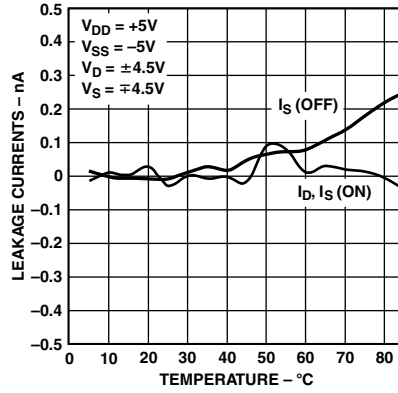

TPC 5. Leakage Currents vs. Temperature – Dual Supply

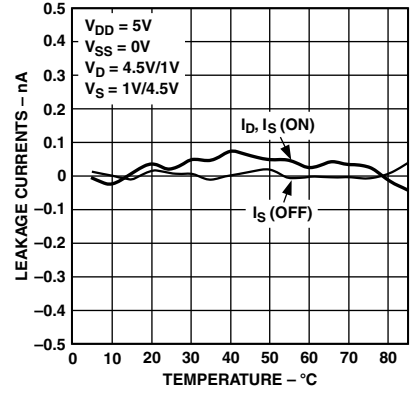

TPC 6. Leakage Currents vs. Temperature – Single Supply

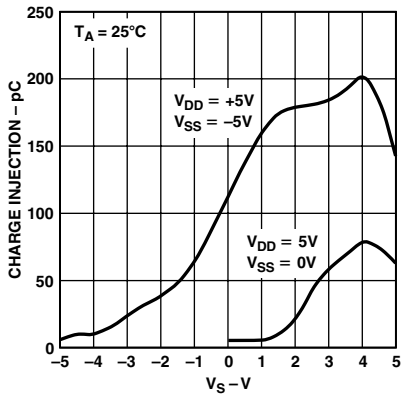

TPC 7. Charge Injection vs. Source Voltage

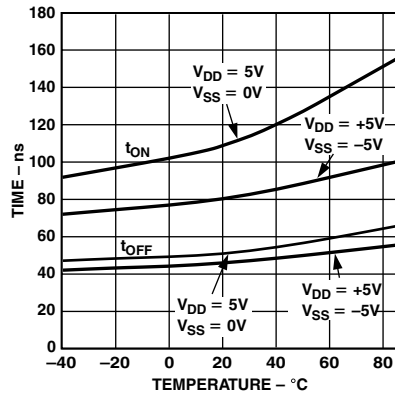

TPC 8. t_{ON}/t_{OFF} Times vs. Temperature

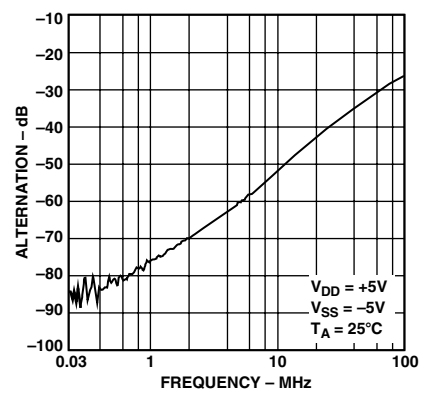

TPC 9. Off Isolation vs. Frequency

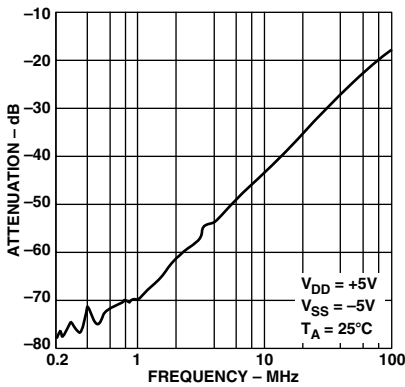

TPC 10. Crosstalk vs. Frequency

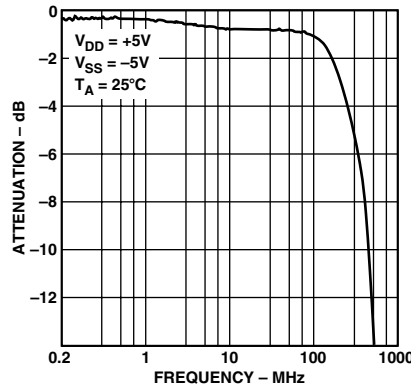

TPC 11. On Response vs. Frequency

TEST CIRCUITS

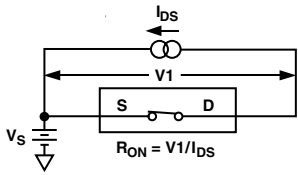

Test Circuit 1. On Resistance

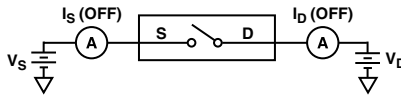

Test Circuit 2. Off Leakage

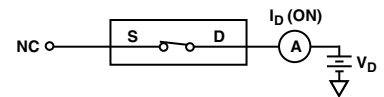

Test Circuit 3. On Leakage

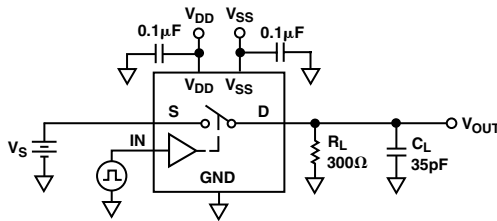

Test Circuit 4. Switching Times

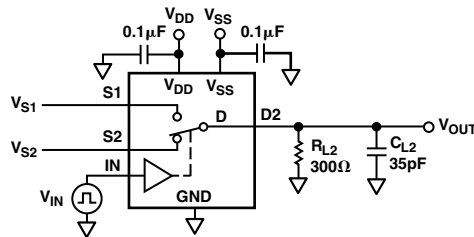

Test Circuit 5. Break-Before-Make Time Delay, t_{BBM} (ADG619 Only)

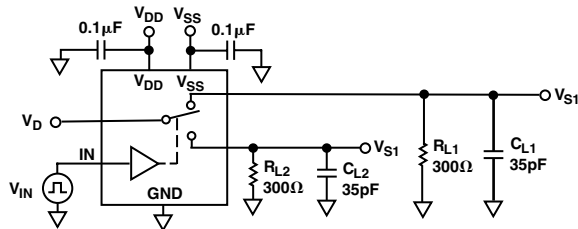

Test Circuit 6. Make-Before-Break Time Delay, t_{MBB} (ADG620 Only)

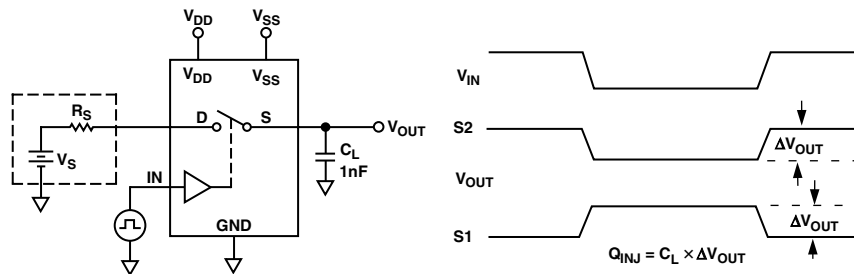

Test Circuit 7. Charge Injection

ADG619/ADG620

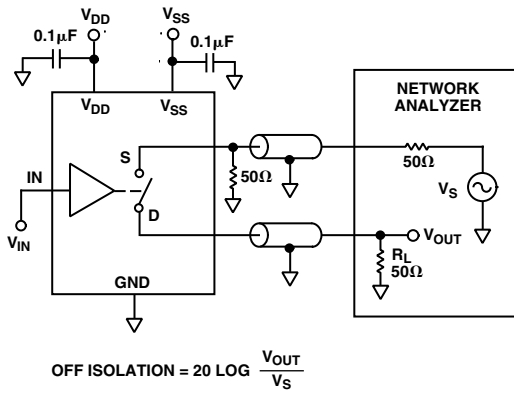

Test Circuit 8. Off Isolation

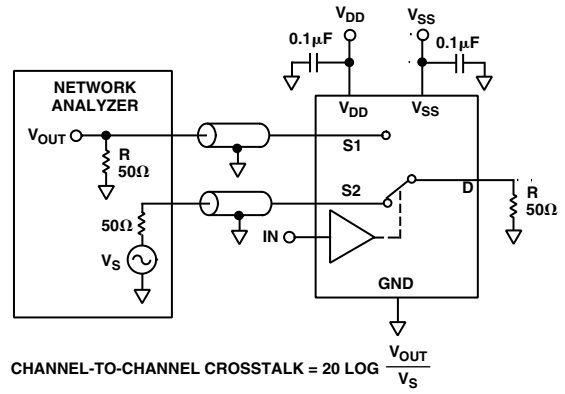

Test Circuit 10. Channel-to-Channel Crosstalk

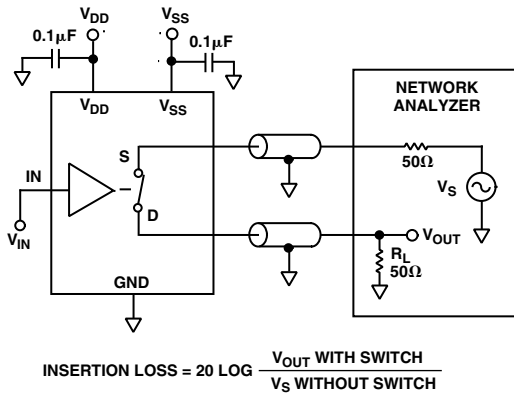

Test Circuit 9. Bandwidth

OUTLINE DIMENSIONS

Dimensions shown in inches and (mm).

8-Lead Micro-SOIC Package (RM-8)

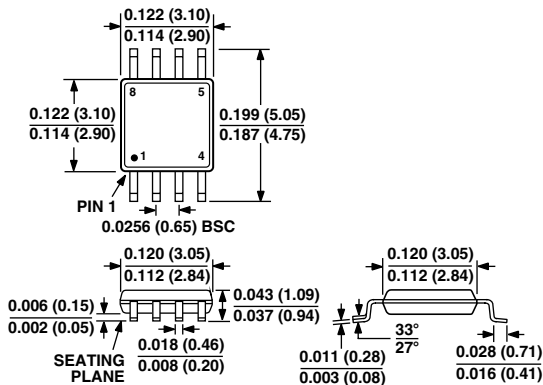

8-Lead Plastic Surface Mount Package (RT-8)

