



Evaluation Board for PC Temperature Monitor and Fan Control ASIC

EVAL-ADM1028

FEATURES

On chip Temperature Sensor
External Temperature Measurement with Remote Diode Interrupt and Overtemperature Outputs
Fault Tolerant Fan Control with Auto Hardware Trip Point Remote Reset and Power Down Functions
LDCM Support
System Management Bus (SMBus) Communications
Standby Mode to Minimize Power Consumption
Limit Comparison of all Monitored Values

APPLICATIONS

Network Servers and Personal Computers
Microprocessor-Based Office Equipment
Test Equipment and Measuring Instruments

INTRODUCTION

The ADM1028 evaluation board allows the ADM1028 PC Temperature Monitor and Fan Control ASIC to be quickly and easily evaluated using a personal computer. Using the evaluation board and the accompanying software the ADM1028 can be interfaced to any personal computer running Windows™ 95 or Windows™ 98, via the computers parallel port.

The evaluation board allows the input and output functions of the ADM1028 to be exercised without the need for external components. The software allows control and monitoring of the ADM1028's internal registers.

THE ADM1028

The following is a brief description of the ADM1028 and a system overview. Further information can be found on the ADM1028 datasheet.

The ADM1028 is a low cost temperature monitor and fan controller for microprocessor based systems. The device can measure the temperature of a microprocessor using an on-chip diode connected transistor or can use a low cost small signal transistor.

Measured values can be read out via the SMBus and values for limit comparisons can be programmed in over the same serial bus.

The ADM1028 also contains a DAC for fan speed control. An automatic hardware temperature trip point is provided and the fan will be driven to full speed if it is exceeded.

The chip also has remote reset and power down functionality, allowing it to be remotely shut down via the SMBus.

EVALUATION SYSTEM PACKAGE CONTENTS

The evaluation system contains the following items

1. The ADM1028 Evaluation Board
2. Centronics Cable
3. CD containing this application note, datasheet and the ADM1028 evaluation software.

EVALUATION BOARD HARDWARE

The ADM1028 evaluation board contains the following main components which can be identified from the block diagram, printed circuit board silk screen and schematic diagram of figures 1, 2 and 3 overleaf.

1. ADM1028 IC
2. NPN sensor transistor
3. LED indicators
4. Interface Buffers
5. Connector for parallel interface.
6. Test Connector for connecting to remote thermal sensor (J4)
7. Fan.

REV. PrA 05/2000

Information furnished by Analog Devices is believed to be accurate and reliable. However, no responsibility is assumed by Analog Devices for its use, nor for any infringements of patents or other rights of third parties which may result from its use. No license is granted by implication or otherwise under any patent or patent rights of Analog Devices.

One Technology Way, P.O. Box 9106, Norwood, MA 02062-9106, U.S.A.
Tel: 781/329-4700 World Wide Web Site: <http://www.analog.com>
Fax: 781/326-8703 Analog Devices, Inc., 1998

EVAL-ADM1028

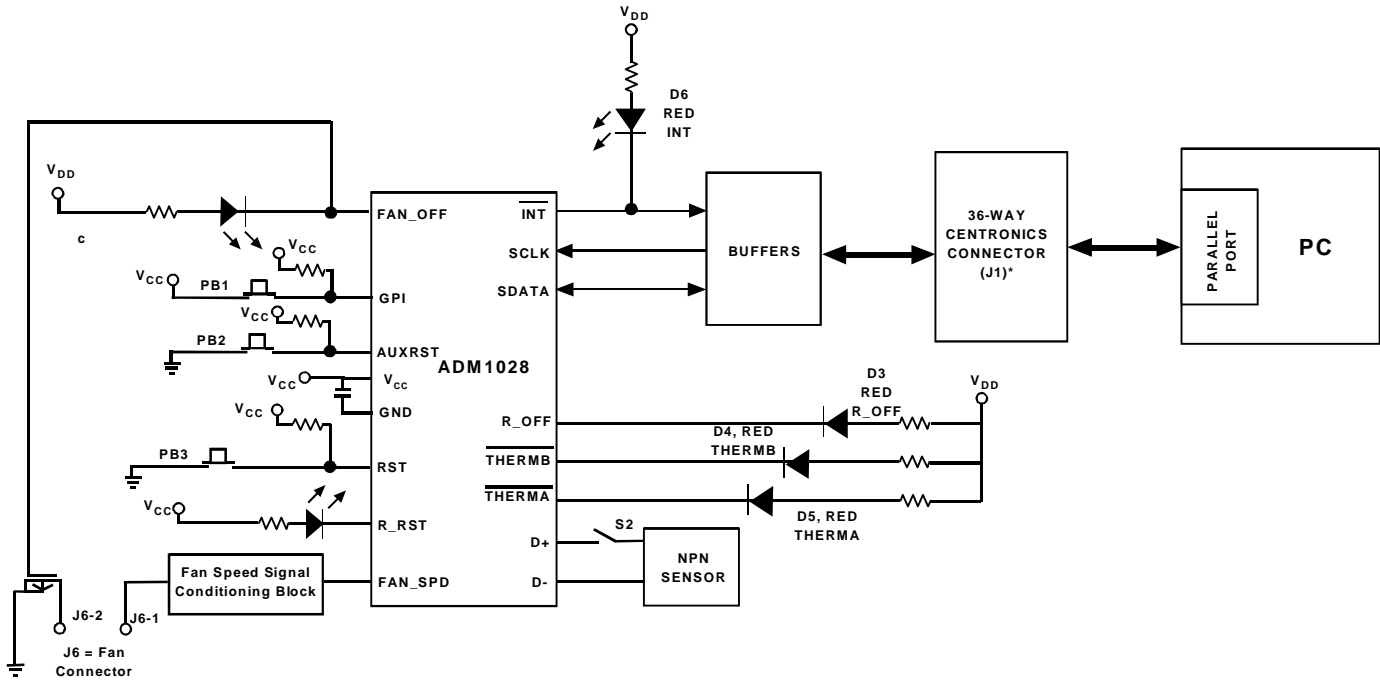

Figure1. ADM1028 Evaluation Board Block Diagram

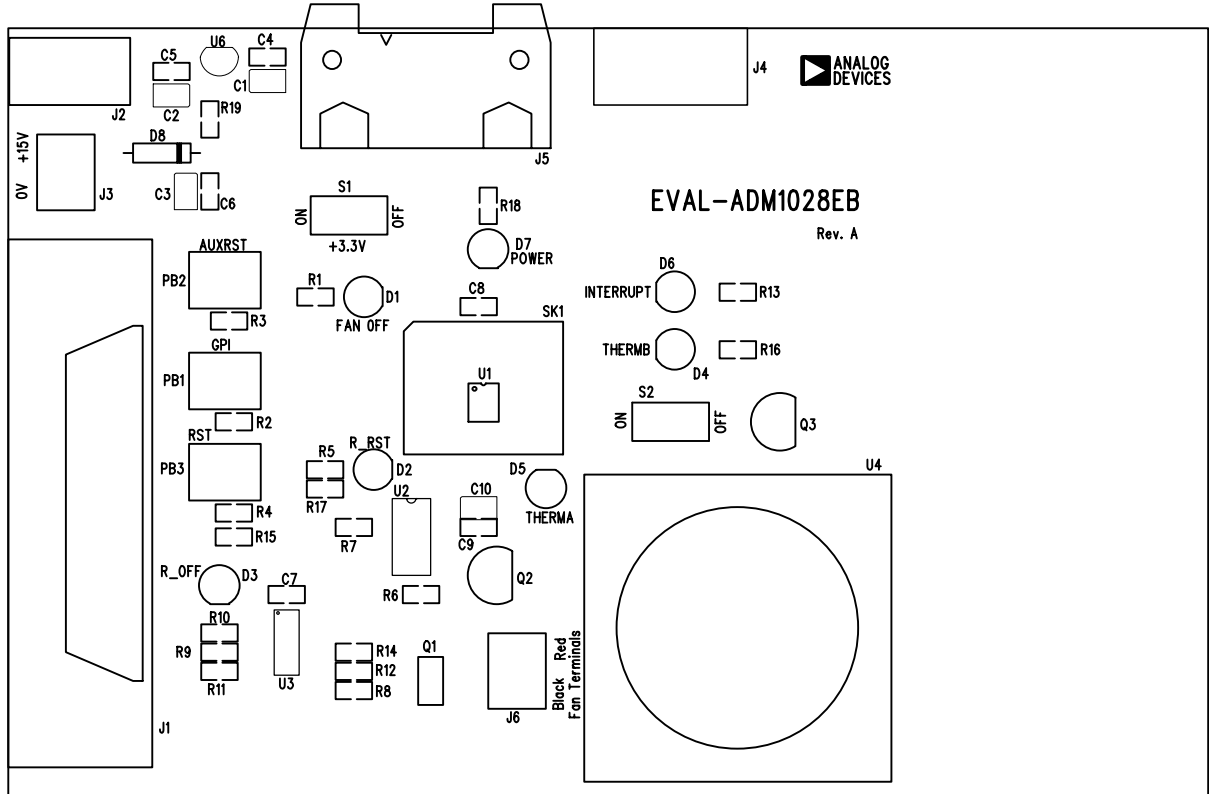

Figure2. ADM1028 Evaluation Board Silk Screen

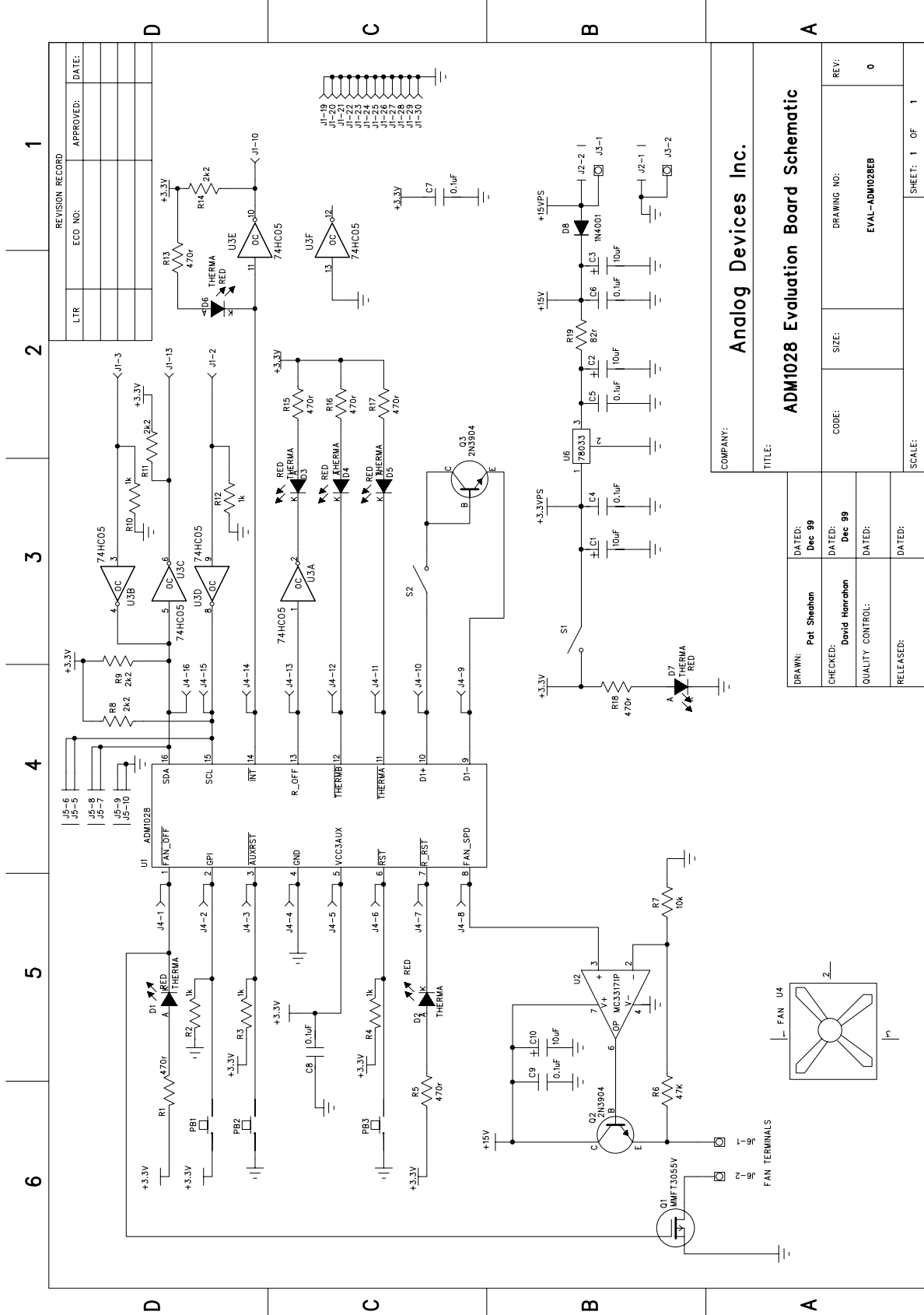

Figure3. ADM1028 Evaluation Board Schematic

EVAL-ADM1028

CONNECTORS AND SWITCHES AND INDICATORS

The function of the various connectors, switches and indicators on the evaluation board are explained below.

CENTRONICS CONNECTOR (J1)

The evaluation board may be connected to the personal computer via the parallel printer port using the centronics cable provided.

POWER CONNECTORS (J2 & J3)

Power is supplied to the board via J2 using a 15V Power Supply mains adaptor. This adaptor is not included in the evaluation kit. Alternatively power may be supplied to the board via J3 thus allowing a desktop power supply to be used.

TEST CONNECTOR (J4)

J4 is provided as a test connector on the ADM1028 evaluation board. Each pin of the ADM1028 is connected directly to the corresponding pin of the test connector thus allowing the user easy access to all signals to and from the ADM1028 (i.e. pin 1 of the ADM1028 is connected to pin 1 of the test connector).

An off board thermal sensor may be connected as the external sensor via pins 9 and 10 of the test connector.

SMBUS INTERFACE CONNECTOR (J5)

The SMBus interface connector allows the evaluation board to be connected to the SMBus of a personal computer using a DIMM interface card. To make this connection it may be necessary to remove one of the DIMM memory modules on the PC motherboard, if all DIMM sockets are occupied. This will affect the BIOS setup and Windows 95 and should only be attempted by a competent user.

ON/OFF SWITCH (S1)

This is simply an on/off switch for the evaluation board.

REMOTE DIODE SWITCH (S2)

This switch allows the user to choose between the on-board remote temperature sensor (Q3) and one that can be connected to the test connector J4. When the switch is in the on position the Q3 is selected. When it is in the off position the off board sensor is selected.

FAN_OFF INDICATOR (D1)

When the FAN_OFF pin is asserted low this indicates a request to switch off the fan regardless of the fan_spd output. When this occurs the FAN_OFF LED will light. When the pin is asserted high again the LED will switch off immediately. The FAN_OFF pin is asserted low when bit 5 of the configuration register is set to 0. This bit defaults to 1 on power up.

R_RST INDICATOR (D2)

Writing a 1 to the R_RST Register of the Remote Function Register causes the R_RST pin to be pulsed low for a minimum of 125µs. This bit will self clear to 0 when the R_RST pulse is complete. As a result the LED will only light for the duration of the pulse.

R_OFF INDICATOR (D3)

Writing a 1 to the R_OFF bit of the Remote Function Register causes the R_OFF output to be driven high. This in turn causes the R_OFF LED to light. This bit is cleared only when RST is asserted, i.e. the LED will remain lighting until the RST button (PB3) is pressed.

THERMA & THERMB INDICATORS (D4 & D5)

These LED's light when the THERM temperature limits are exceeded for more than three consecutive measurements. THERMA and THERMB are functionally identical. THERMA has an internal pullup to 3.3V while THERMB is open drain and can be pulled up to any required voltage. See datasheet for more information.

The LED's will switch off when the temperature falls to 5°C below the THERM limit for three consecutive measurements

INTERRUPT LED (D6)

This LED illuminates whenever the ADM1028 issues an interrupt signal (eg.when an out of limit measurement is made). For more information on the various conditions which cause INT to be pulled low please see the datasheet.

POWER LED (D7)

This LED will illuminate whenever power is supplied to the board and S1 is in the ON condition.

GPI INPUT SWITCH(PB1)

This switch essentially allows the user to generate an out of limit measurement for the GPI (General Purpose Input). This should result in an INT being generated if the GPI interrupt is not masked.

AUXRST SWITCH (PB2)

Pulling AUXRST low will reset the ADM1028. AUXRST is an input to the ADM1028. Pressing the AUXRST switch will reset the ADM1028, setting all the registers to their default values.

RST SWITCH (PB3)

This pin can be pulled low externally to indicate that to the ADM1028 that the main system power has been removed. This will cause the ADM1028 to shut off its FAN_SPD output and reset its R_OFF output.

THE SOFTWARE

The software allows the ADM1028's functions to be controlled from the PC via an easy to use interface operating under the Windows™ environment. The contents of the devices internal registers can easily be read or altered through a user friendly graphics interface, while the control center window allows the graphing of the temperature readings.

INSTALLING THE SOFTWARE

To install the software insert the Analog Devices ADM1028 CD-Rom into the CD-Rom Drive. The CD-Rom should autorun and start installing the software. If this does not occur then the user should click on the Start Icon and then on Run Icon and type X:setup.exe as the file name, where X is the drive letter of the CD-Rom drive. To finish installing the software follow the onscreen instructions.

USING THE SOFTWARE

When using the software, first ensure that the evaluation board is connected to the Parallel Printer Port and that the power supply is plugged into the board.

To start the Software, select Start-Programs-Analog Devices- ADM1028 Evaluation Software.

When the program is selected the Software Initialisation Wizard will appear first.

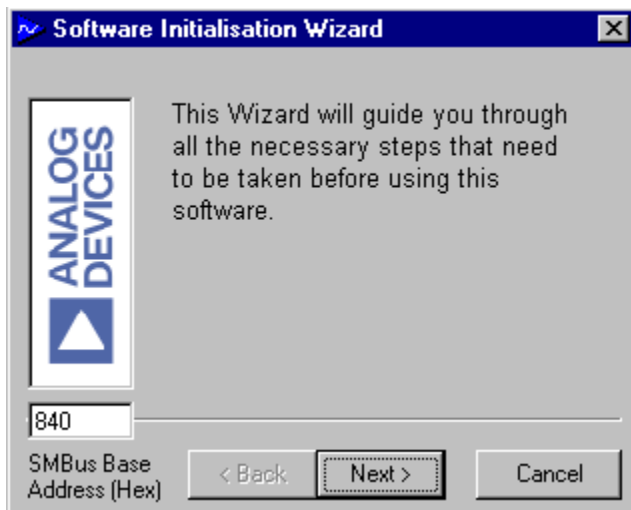

Click on "Next" to go to the next screen, which will allow the user to choose between connecting the evaluation board via the printer port or via the SMBus.



Once the Communications medium has been selected, click on "Next" to go to the next screen. When you are ready for the evaluation software to begin searching for the device on the chosen medium, click on "Next".

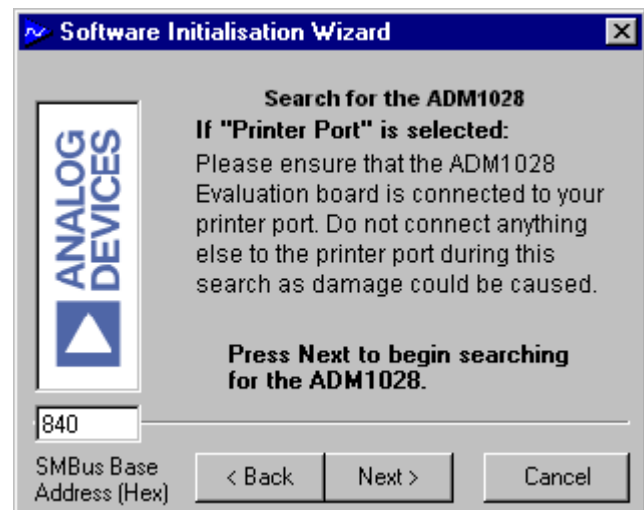

The software will search for the ADM1028 and if it finds it the following screen will appear.

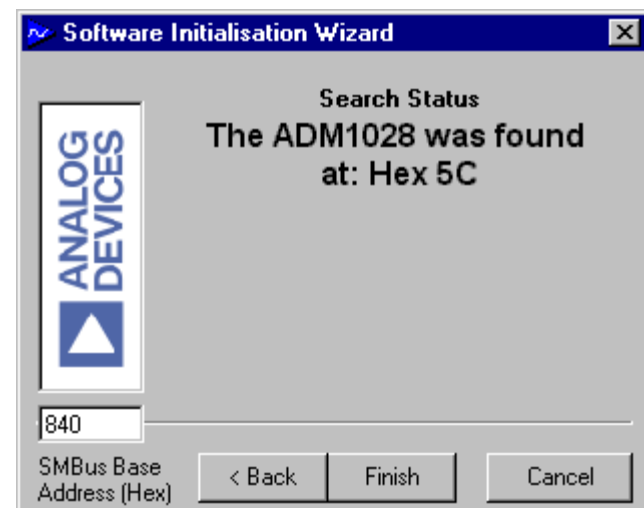

EVAL-ADM1028

If this is the ADM1028 the user wishes to use then click in “Finish” to begin running the software. An index type display will be displayed on the screen.

If the ADM1028 was not found on the chosen medium the following screen will appear.

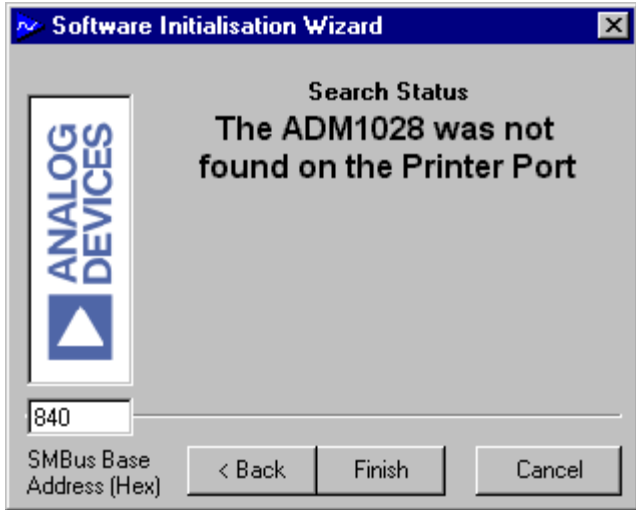

In this case check the connections to the board and the power supply. Also the user should check the position of S1 (on/off switch). If this switch is in the off position then the software will not find the evaluation board. Then click on “Back” and try again. If this does not work then try re-booting the PC and re-running the software.

USING THE SOFTWARE

The index type display which appears on the screen when the software starts to run has three tabs.

MAIN TAB

The main tab shows the software version and allows the user to quit the program by clicking on 

READ/WRITE

This tab displays information about the ADM1028’s internal registers and allows their contents to be read and/or altered. Each register has a button associated with it. Clicking on a button will display the contents of the selected register in the register contents box and the name of each register bit. The register contents are also displayed in hexadecimal and decimal.

Clicking on a register button causes its contents to be read once if contineous reading is off. If contineous reading is on, the register will be updated contineously. Click on the

button to toggle between 

and 

The type of register selected, its hexadecimal address, its current value in hexadecimal and decimal and the previous value written to the register, are also displayed.

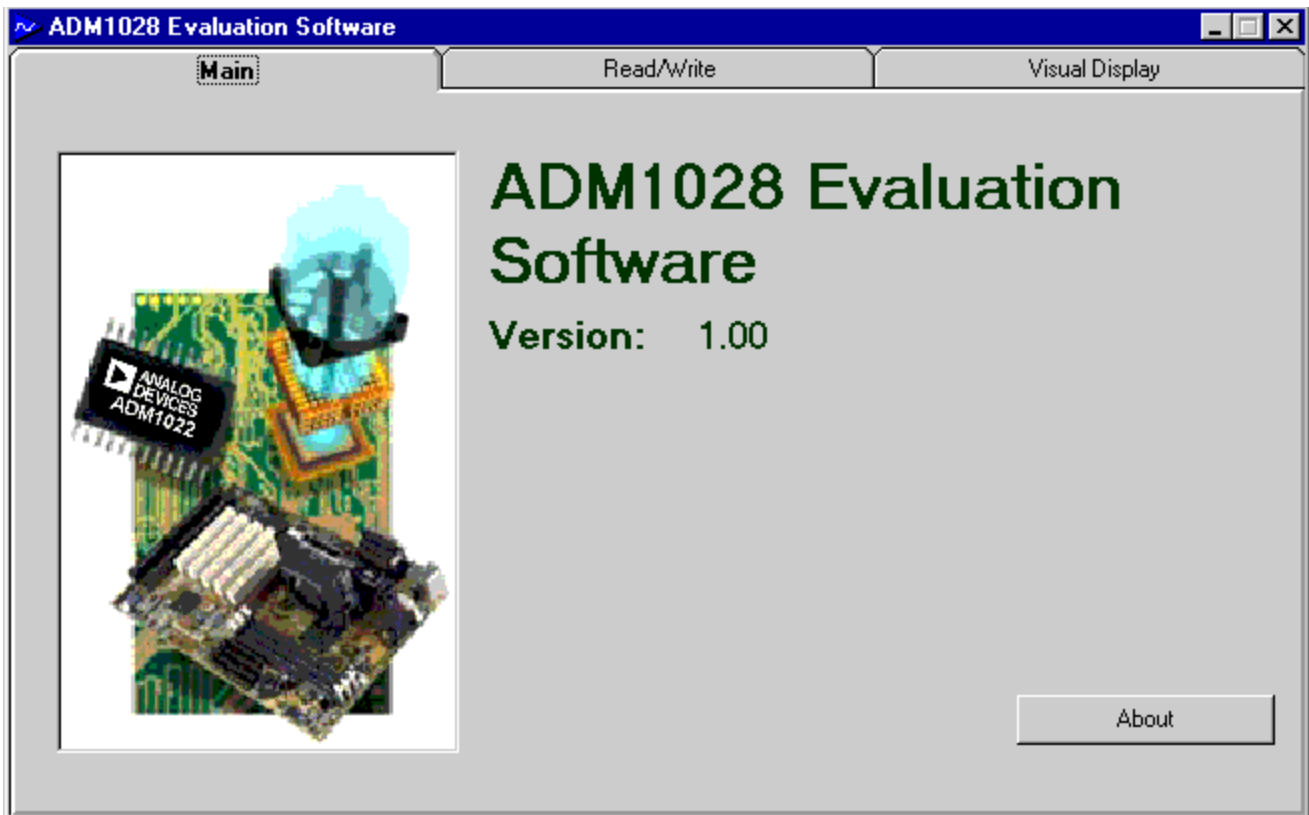

Figure4. ADM1028 Evaluation Software Main Tab

Data may be written to all registers that are Read/Write, (refer to data sheet for more information). When the Read/Write tab is first selected, none of the registers have been written to, and they contain their default values.

Registers may be written to in two ways. Clicking on a bit in the Read/Write display will toggle its value between 0 and 1. This is useful where a function is controlled by setting or clearing individual bits in a register, for example setting or clearing the FAN_OFF bit in the configuration register.

The entire contents of a register may be changed by typing a Hex or decimal value in the text boxes of the Write display. The button will change from green to red and the new value can be written to the register by clicking on the button.



This is useful where a register contains a numeric value such as a temperature limit.

VISUAL DISPLAY

The visual display tab allows readings to be displayed graphically on bargraphs or line graphs.

When the visual display is selected for the first time the value displayed on the bargraph is the value of local temperature at the time visual display was selected. To switch the bargraphs to continuous monitoring of the local and remote temperatures click on either the local or remote temperature buttons on the bargraph display.



Clicking on these buttons will also cause

the line graphs to become active. You can zoom in or out of the line graphs using the arrows on both the time and temperature axes.

EASY SETUP

The line and bargraphs can also be started by clicking on the  button. This also sets the limits for both local and remote temperature. The low limit is 0°C and the high limit is 90°C for both local and remote.

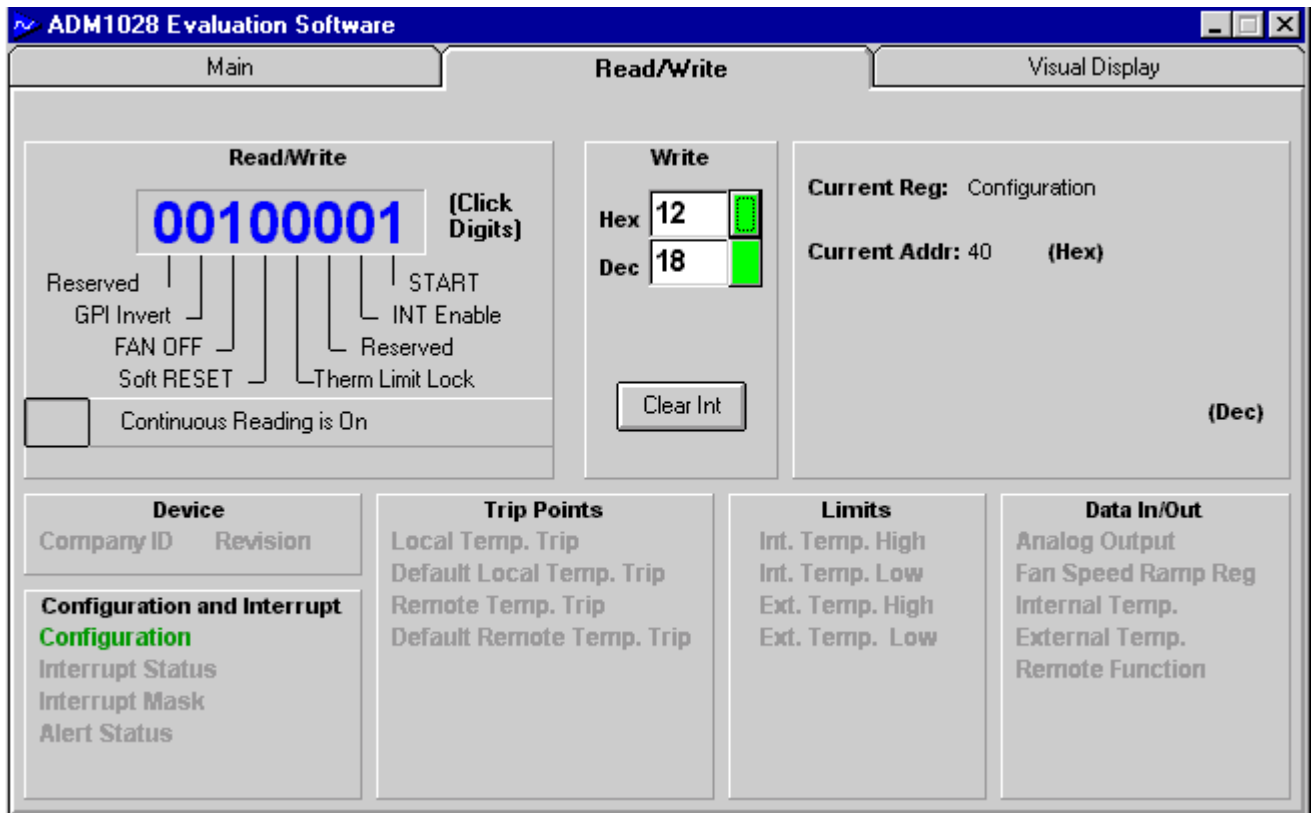

Figure5 . ADM1028 Read/Write Program Tab

EVAL-ADM1028

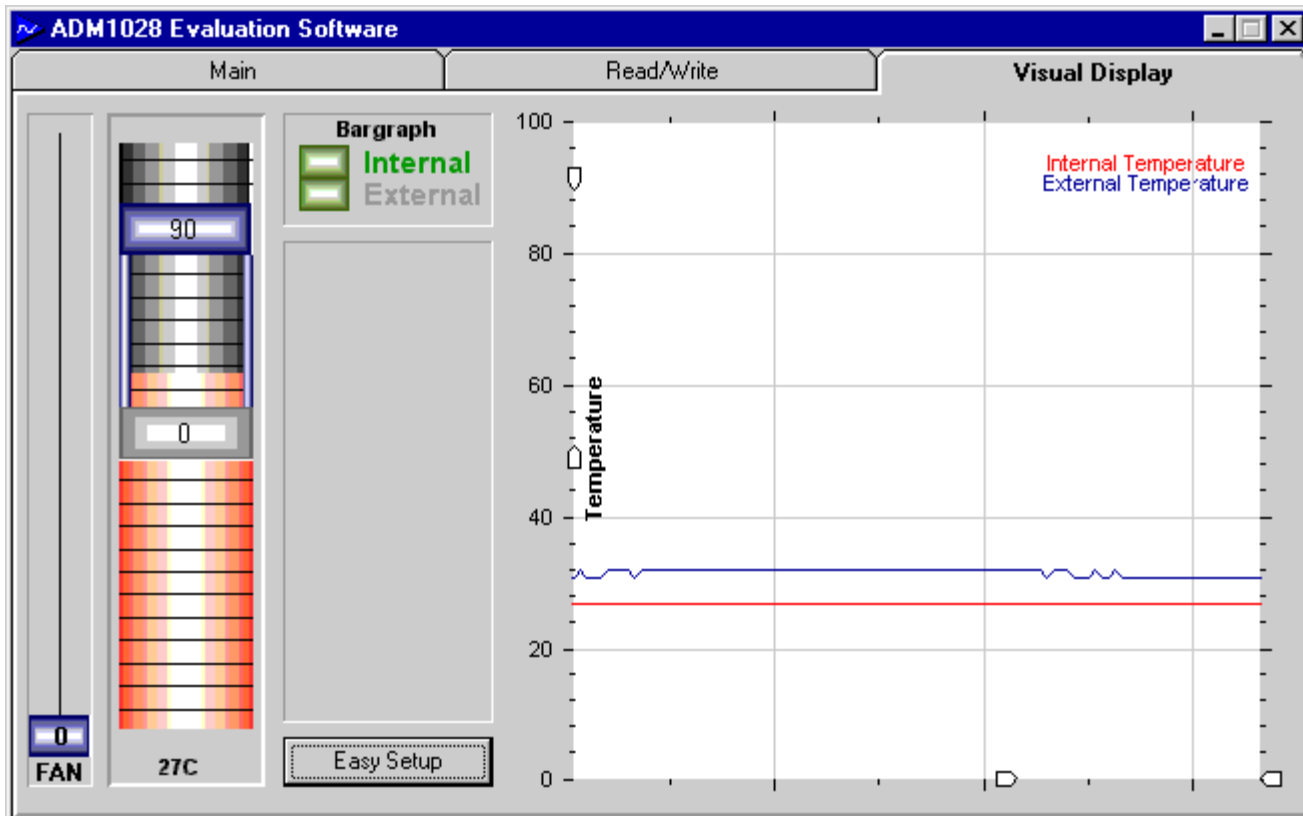

Figure6. ADM1028 Visual Display Program Tab

APPENDIX A. COMPONENT LIST**Capicators**

C1-3, C10	10 μ F
C4-9	0.1 μ F

Diodes

D1-6	Red LED
D7	Green LED
D8	Diode

Connectors

J1	Centronics
J2	Con-Barrel
J3, J6	Con-Power
J4	16 Header Con
J5	Con-RIB 10HL

Resistors

R1, R5, R13, R15-18	470 Ω
R2, R3, R4, R10, R12	1k Ω
R6	47k Ω
R7	10k Ω
R8, R9, R11, R14	2.2k Ω
R19	80 Ω

Switches

S1-2	2-way switch
PB1-3	Pushbutton Sw.

Semiconductors

Q1	NDT3055L
Q2, Q3	2N3904
U1	ADM1028
U2	MC33171P
U3	74HC05
U4	Fan
U6	78033