



Evaluation Board for ACPI Temperature Monitor and PWM Fan Controller

Preliminary Technical Data

EVAL-ADM1030/31

FEATURES

Optimized for Pentium III @:- Allows Reduced Guardbanding
Programmable (ACPI) and Automatic Fan Speed Control
Automatic Fan Speed Control allows control Independent of CPU Intervention after initial setup.
Control Loop minimizes Acoustic Noise and Battery Consumption
RPM Feedback mode to maintain constant fan speed
Remote Temperature measurement accurate to 1°C using Remote Diode (2 channels for ADM1031, 1 for ADM1030)
0.125°C Resolution on External Temperature Channels
Local Temperature Sensor with 0.25°C resolution
Pulse Width Modulation Fan Control (PWM) (two fans for ADM1031, one fan for ADM1030)
Programmable PWM Frequency
Programmable PWM Duty Cycle
Tach Fan Speed Measurement (One Channel for ADM1030, Two for ADM1031)
Analog Inputs to measure Fan Speed of 2-wire fans (using Sense Resistor)
2-Wire Serial System Management Bus(SMBus) with ARA
Over-Temperature $\overline{\text{THERM}}$ Output Pin
Programmable $\overline{\text{INT}}$ Output Pin
Configurable Offsets for Temperature Channels
3V to 5.5V Supply Range
Shutdown Mode to Minimize Power Consumption
Limit Comparisons of all Monitored Values

APPLICATIONS

Notebook PC's, Network Computers and Personal Computers
Microprocessor Based Office Equipment.

INTRODUCTION

The ADM1030/31 evaluation board allows the ADM1030/31 PC Temperature Monitor and PWM Fan Controller to be quickly and easily evaluated using a personal computer. Using the evaluation board and the accompanying software the ADM1030/31 can be interfaced to any personal computer running Windows™ 95 or Windows™ 98 via the computer's parallel port.

The evaluation board allows the input and output functions of the ADM1030/31 to be exercised without the need for external components. The software allows control and monitoring of the ADM1030/31's internal registers.

THE ADM1030/31

The following is a brief description of the ADM1030/31 and a system overview. Further information can be found on the ADM1030 and ADM1031 datasheet.

The ADM1030 and ADM1031 function in a very similar manner. The main difference is that the ADM1031 is dual channel and the ADM1030 is single channel i.e. the ADM1031 has a second remote temperature measurement channel, a second fan speed measurement channel and a second PWM fan speed control channel.

The ADM1030/31 is an ACPI compliant two/three channel digital thermometer and under/over temperature alarm, for use in personal computers. A PWM Fan Control Output controls the speed of cooling fans. The speed of these fans may be monitored using the Tach Inputs. A dedicated Fan Speed Control Loop provides control even without CPU Intervention.

The device has a programmable $\overline{\text{INT}}$ output to indicate error conditions. The $\overline{\text{THERM}}$ pin is a failsafe output for over temperature conditions.

EVALUATION SYSTEM PACKAGE CONTENTS

The evaluation system contains the following items

1. The ADM1030/31 Evaluation Board
2. Centronics Cable
3. CD containing this application note, datasheet and the ADM1030/31 evaluation software.

EVALUATION BOARD HARDWARE

The ADM1030/31 evaluation board contains the following main components which can be identified from the block diagram, printed circuit board silk screen and schematic diagram of Figures 1, 2 and 3 overleaf.

1. ADM1030 or ADM1031 IC
2. 1 or 2 NPN sensor transistors (depending on whether ADM1030 or ADM1031 IC is used)
3. LED indicators
4. Interface Buffers
5. Connector for parallel interface.
6. Test Connector for connecting to remote thermal sensor (J7)
7. Fan (1 or 2 depending on IC).

REV. PrA 10/2000

Information furnished by Analog Devices is believed to be accurate and reliable. However, no responsibility is assumed by Analog Devices for its use, nor for any infringements of patents or other rights of third parties which may result from its use. No license is granted by implication or otherwise under any patent or patent rights of Analog Devices.

One Technology Way, P.O. Box 9106, Norwood, MA 02062-9106, U.S.A.
Tel: 781/329-4700 World Wide Web Site: <http://www.analog.com>
Fax: 781/326-8703 Analog Devices, Inc., 2000

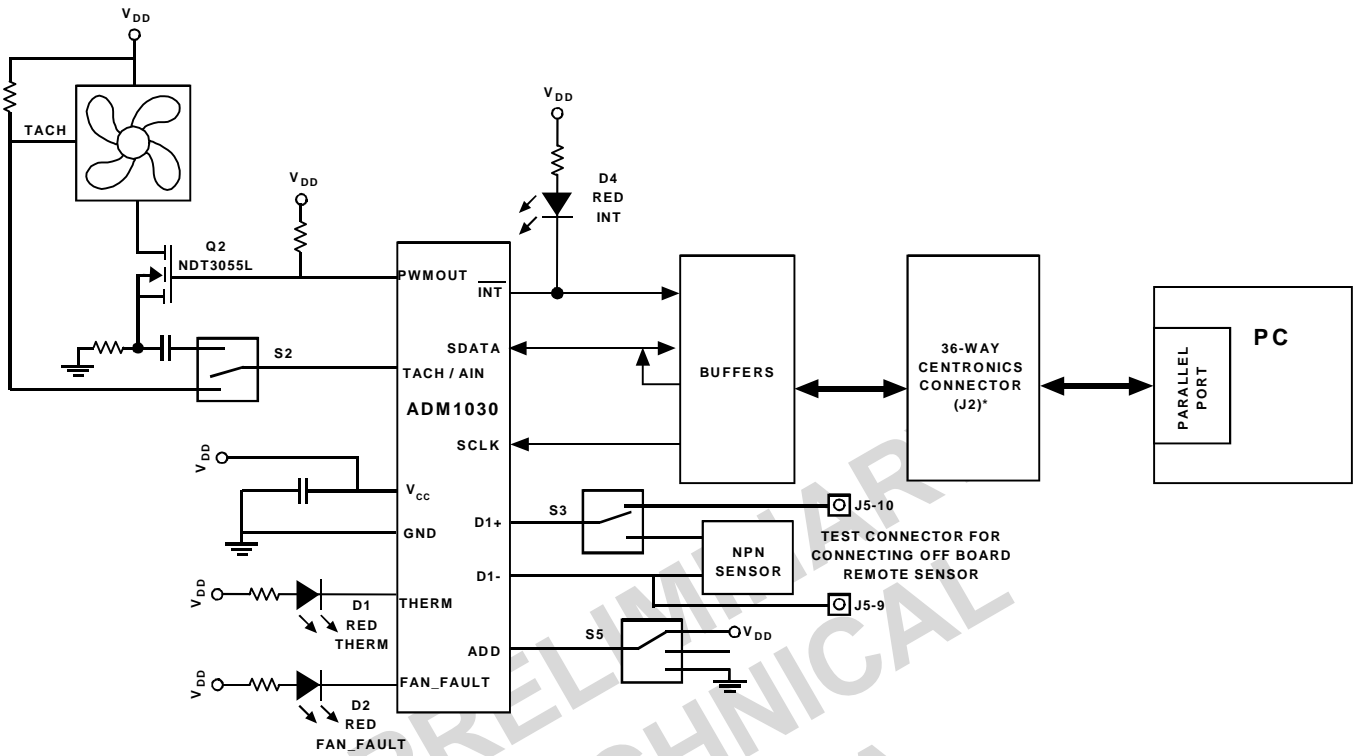

Figure1. ADM1030 Evaluation Board Block Diagram



Figure2. ADM1030 Evaluation Board Picture

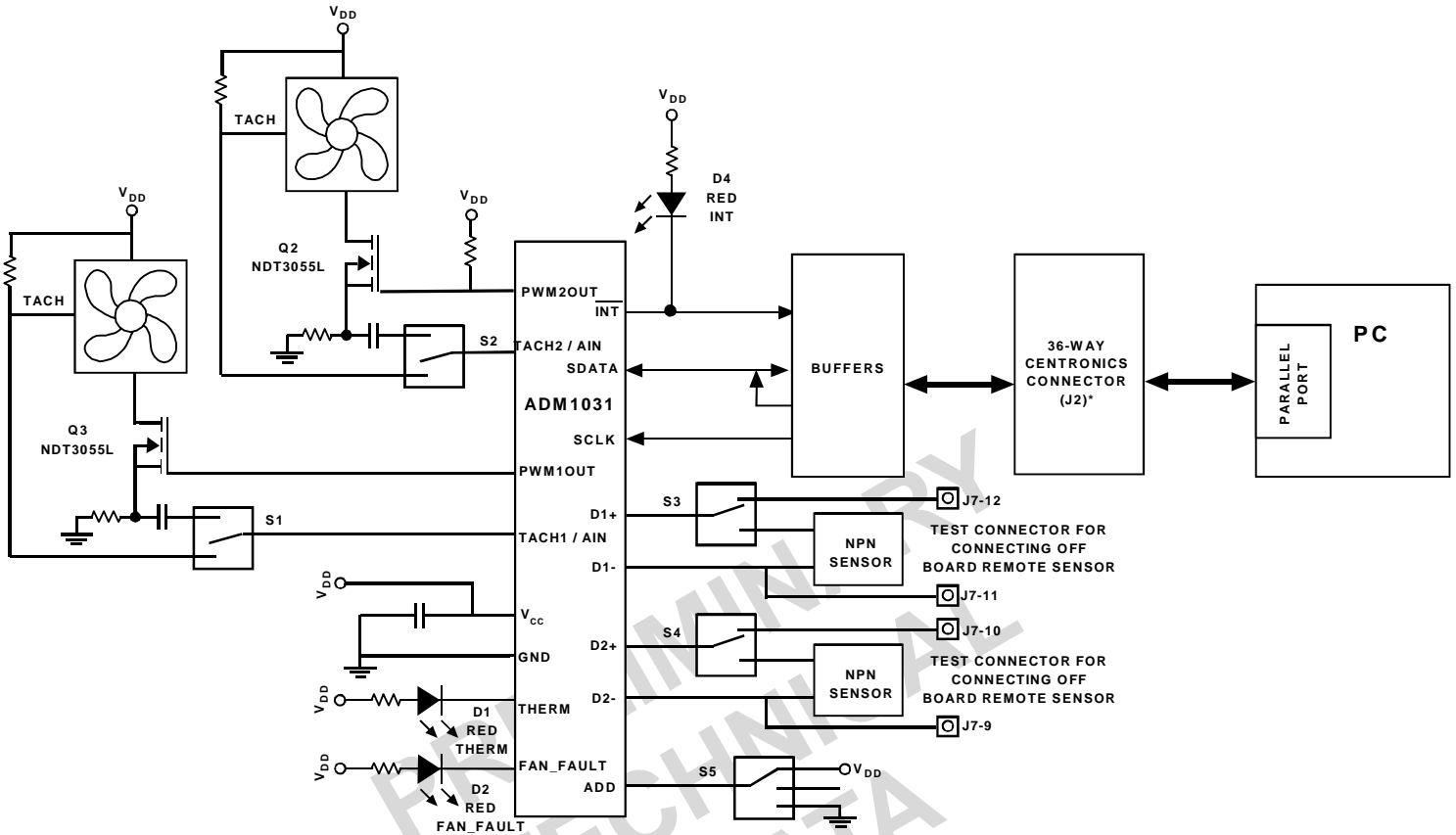

Figure1. ADM1031 Evaluation Board Block Diagram

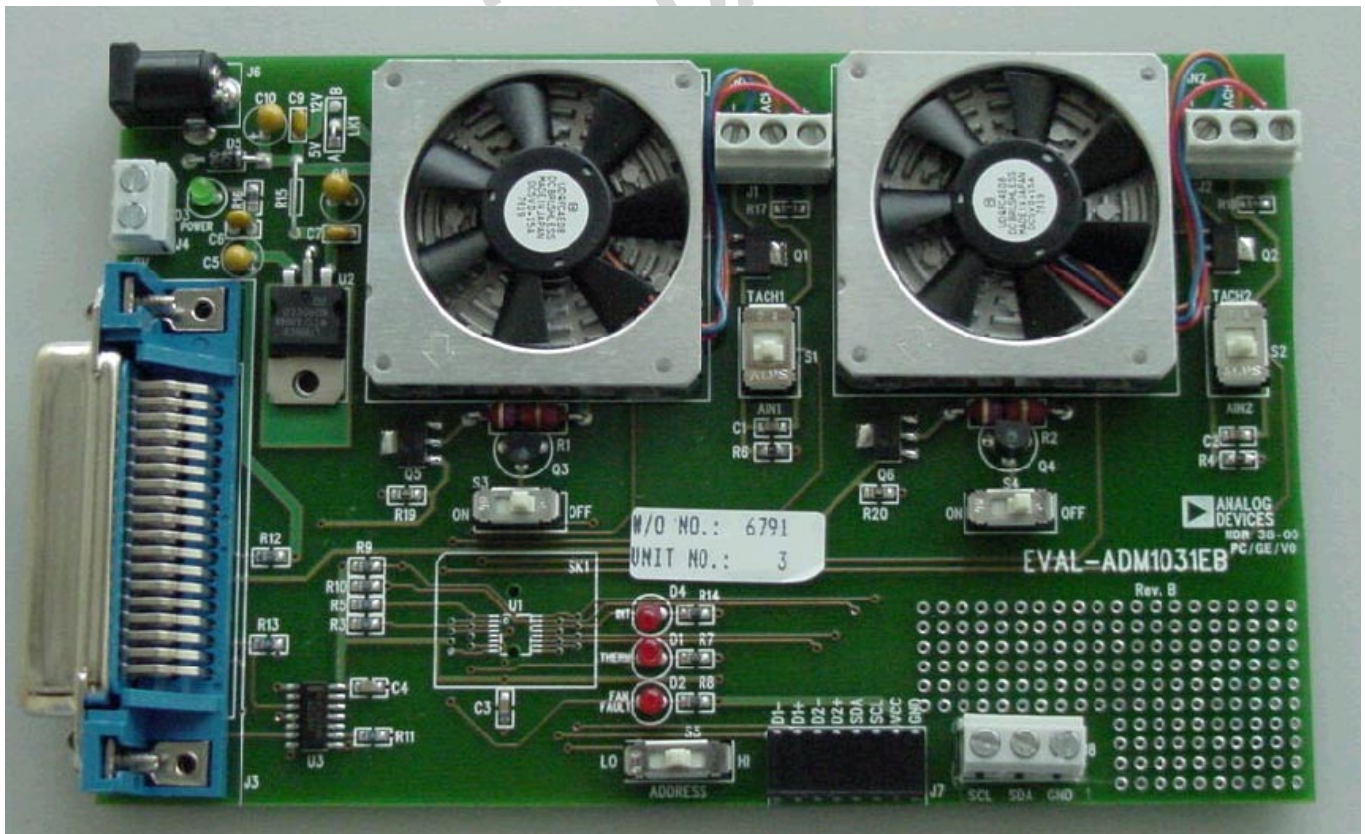

Figure2. ADM1031 Evaluation Board Picture

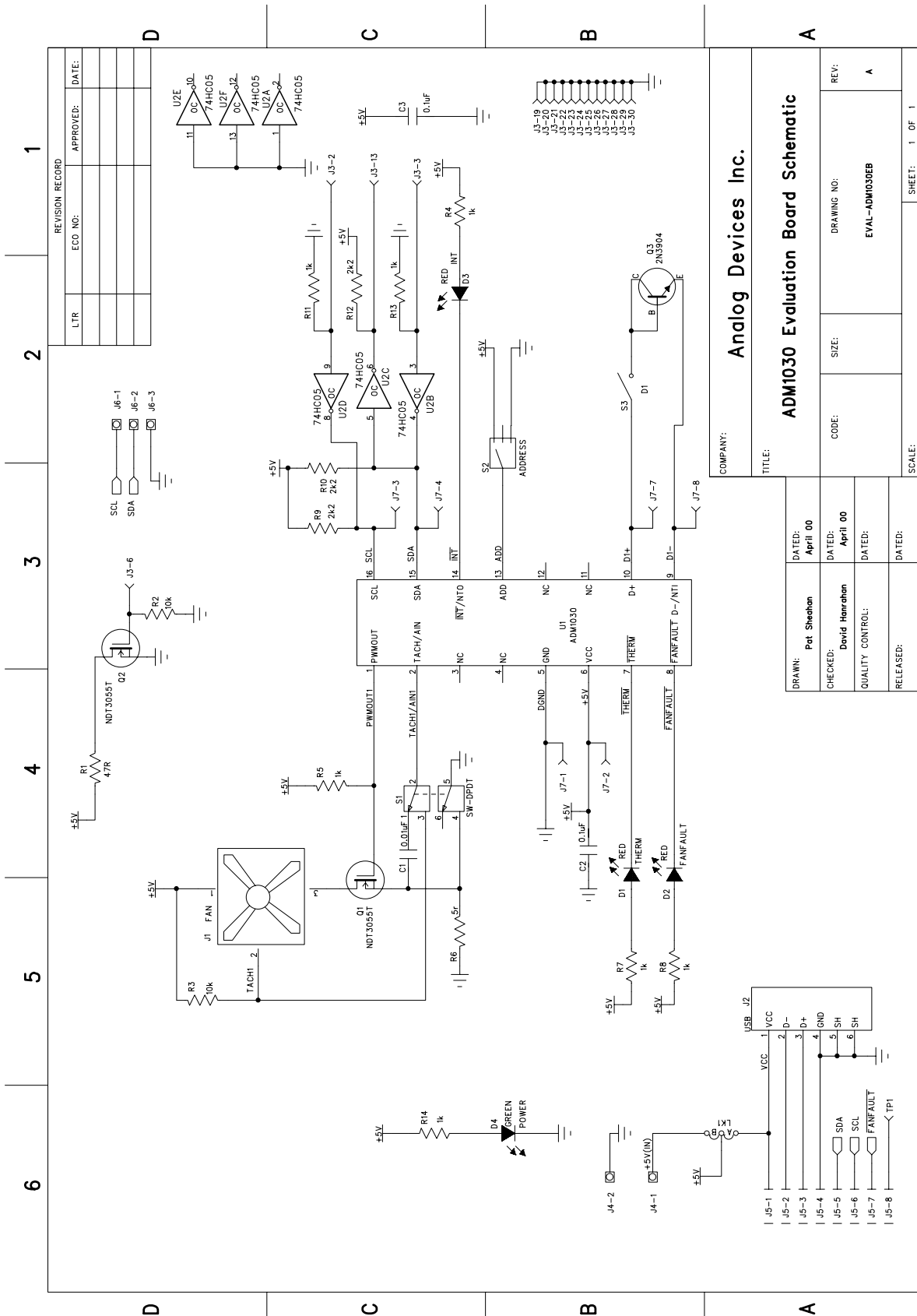

Figure3. ADM1030/31 Evaluation Board Schematic

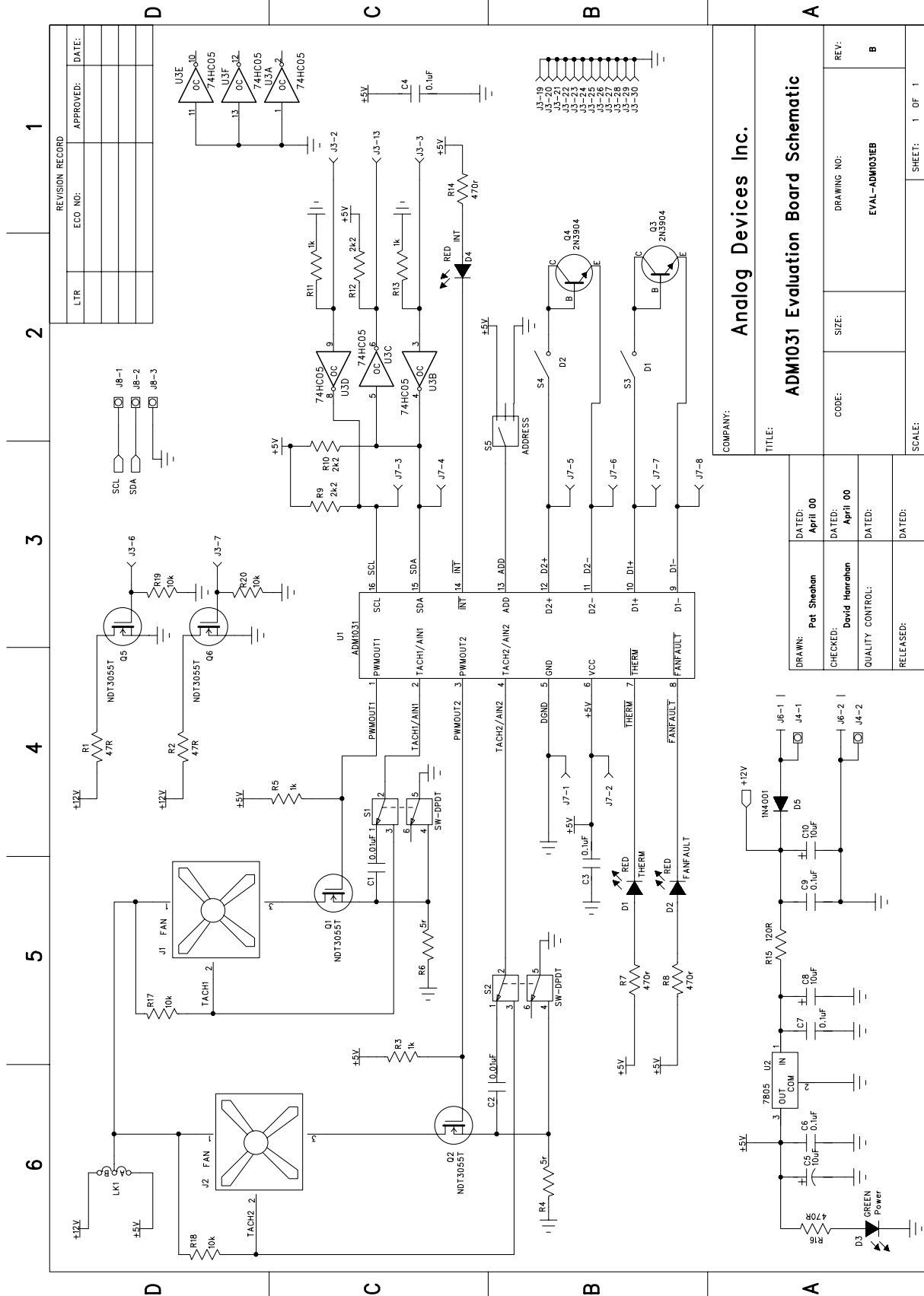

Figure3. ADM1030/31 Evaluation Board Schematic

CONNECTORS AND SWITCHES AND INDICATORS

The function of the various connectors, switches and indicators on the evaluation board are explained below.

CENTRONICS CONNECTOR (J3)

The evaluation board may be connected to the personal computer via the parallel printer port using the centronics cable provided.

POWER CONNECTORS (J4 & J6)

Power is supplied to the board via J6 using a 15V Power Supply mains adaptor. This adaptor is not included in the evaluation kit. Alternatively power may be supplied to the board via J4 thus allowing a desktop power supply to be used.

TEST CONNECTOR (J7)

J7 is provided as a test connector on the ADM1030/31 evaluation board. The remote thermal diode pins, SMBus and Power pins are all connected to here. This allows the user easy access to ADM1030/31 signals.

An off board thermal sensor may be connected as the external sensor via the remote thermal diode pins of the test connector.

FAN CONNECTORS (J1 AND J2)

The fans which are to be controlled by the ADM1030/31 are connected to the board using these connectors.

SMBUS CONNECTOR (J8)

This connector allows the user easy access to the SMBus signals and may be used if the user wishes to communicate with the ADM1030/31 in a different way other than using the Centronics connector.

TACHAIN SWITCH (S1 AND S2)

This essentially allows the user to switch between a fan with a Tach Signal and one without. In this case switching off the Tach signal will automatically switch in the Rsense circuit which is used to determine the fan speed without the Tach signal. Details of this method of fan speed measurement are provided on the datasheet.

REMOTE DIODE SWITCH (S3 AND S4)

This switch allows the user to choose between the on-board remote temperature sensors (Q3 and Q4) and ones that can be connected to the test connector J7. When the switch is in the on position the on-board sensors are selected. When it is in the off position the off-board sensor is selected.

ADDRESS SELECT SWITCH (S5)

The ADM1030/31 has an SMBus Address pin (ADD). This is a tri-state logic input which sets the lower 2 bits of the SMBus address.

TABLE1. ADD PIN TRUTH TABLE

ADD Pin	A1	A0	SW5
Gnd	0	0	Lo
No Connect	1	0	Center
Vcc	0	1	Hi

THERM LED (D1)

This LED illuminates whenever a measured temperature exceeds a pre-programmed $\overline{\text{THERM}}$ Limit.

FAN_FAULT LED (D2)

This LED will illuminate whenever a fan fault is detected. If there is a second fan connected then this should spin up to full speed.

POWER LED (D3)

This LED illuminates whenever power is supplied to the board.

INT LED (D4)

This LED illuminates whenever the ADM1030/31 issues an interrupt signal (eg. when an out of limit measurement is made). For more information on the various conditions which cause INT to be pulled low please see the datasheet.

THE SOFTWARE

The software allows the ADM1030/31's functions to be controlled from the PC via an easy to use interface operating under the Windows™ environment. The contents of the device's internal registers can easily be read or altered through a user-friendly graphics interface, while the control center window allows the graphing of the temperature readings.

INSTALLING THE SOFTWARE

To install the software insert the Analog Devices ADM1030/31 CD-ROM into the CD-ROM Drive. The CD-ROM should autorun and start installing the software. If this does not occur then the user should click on the Start Icon and then on Run Icon and type X:\setup.exe as the file name, where X is the drive letter of the CD-ROM drive. To finish installing the software follow the on-screen instructions.

USING THE SOFTWARE

When using the software, first ensure that the evaluation board is connected to the Parallel Printer Port and that the power supply is plugged into the board.

To start the Software, select Start-Programs-Analog Devices- ADM1030/31 Evaluation Software.

When the program is selected the Software Initialisation Wizard will appear first.



Once the Communications medium has been selected, click on "Next" to go to the next screen. When you are ready for the evaluation software to begin searching for the device on the chosen medium, click on "Next".

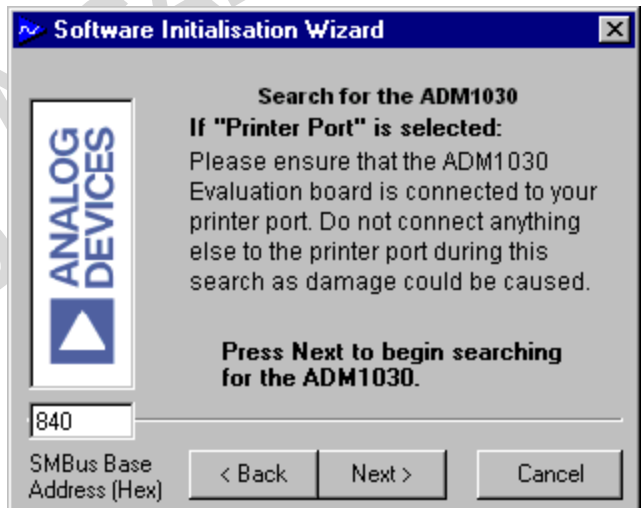

The software will search for the ADM1030 or ADM1031 and if it finds it the following screen will appear.

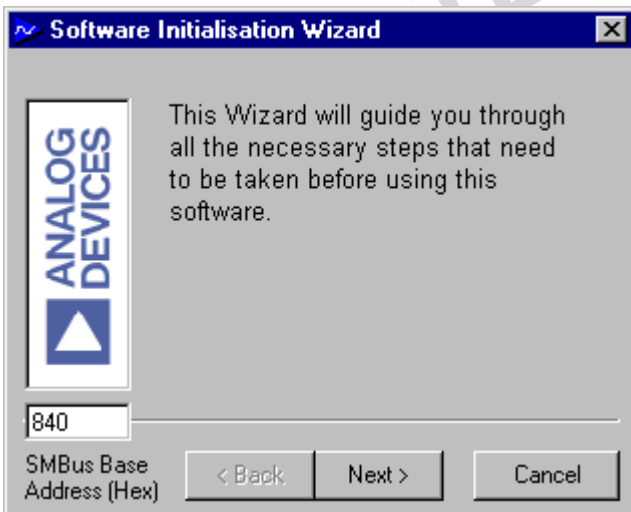

Click on "Next" to go to the next screen, which will allow the user to choose between connecting the evaluation board via the printer port, via the SMBus or via USB. However the USB option is not available on this revision of the evaluation board and so should not be selected.

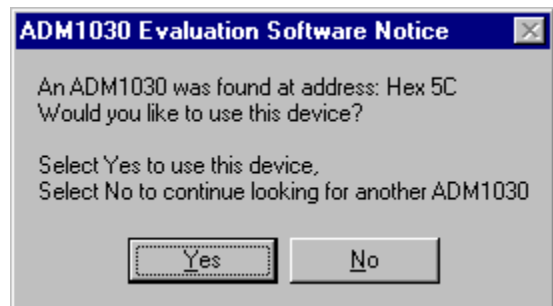

Click on "Yes" if this is the ADM1030 or ADM1031 you wish to use. The next screen should then appear.

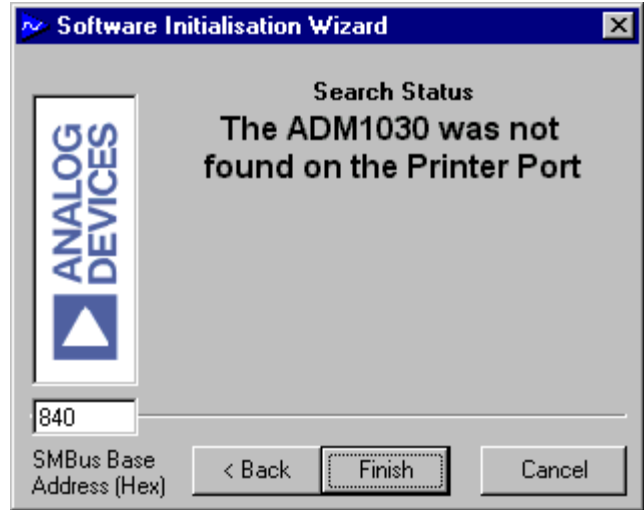

If the ADM1030 or ADM1031 was not found on the chosen medium the following screen will appear.

In this case check the connections to the board and the power supply. Then click on "Back" and try again. If this does not work then try re-booting the PC and re-running the software.

USING THE SOFTWARE

The index type display which appears on the screen when the software starts to run has four tabs.

MAIN TAB

The main tab shows the software version and allows the user to quit the program by clicking on 

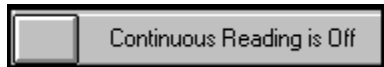

Figure4. ADM1030/31 Evaluation Software Main Tab

READ/WRITE

This tab displays information about the ADM1030/31's internal registers and allows their contents to be read and/or altered. Each register has a button associated with it. Clicking on a button will display the contents of the selected register in the register contents box and the name of each register bit.

Clicking on a register button causes its contents to be read once if continuous reading is off. If continuous reading is on, the register will be updated continuously. Click on the button to toggle between



and

The type of register selected and its hexadecimal address is displayed on the right hand side of the screen.

Data may be written to all registers that are Read/Write, (refer to data sheet for more information). When the Read/Write tab is first selected, none of the registers have been written to, and they contain their default values.

Registers may be written to in two ways. Clicking on a bit in the Read/Write display will toggle its value between 0 and 1. This is useful where a function is controlled by setting or clearing individual bits in a register, for example setting or clearing the Int_Enable bit in the configuration register.

The entire contents of a register may be changed by typing a Hex or decimal value in the text boxes of the Write display. The button will change from green to red and the new value can be written to the register by clicking on the red button.

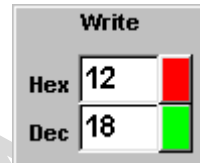

This is useful where a register contains a numeric value such as a temperature limit.

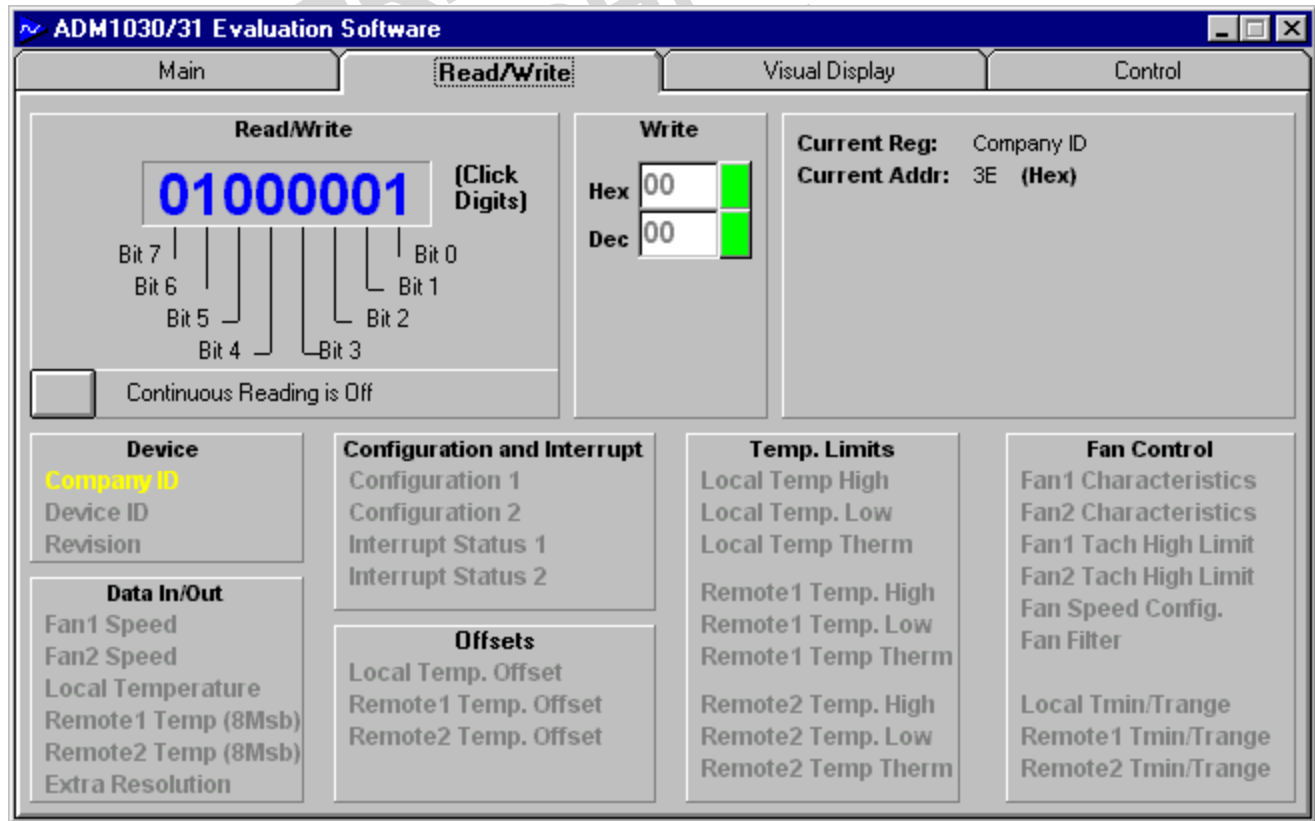
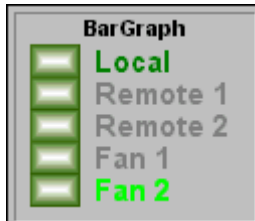

Figure5 . ADM1030/31 Read/Write Program Tab

VISUAL DISPLAY

The visual display tab allows readings to be displayed graphically on bargraphs or line graphs.

When the visual display is selected for the first time the value displayed on the bargraph is the value of local temperature. To display one of the other values e.g. remote temperature or fan speed click on the relevant bar graph button.



FAN SPEED CONTROL

The user may also control fan speed using the PWM duty cycle select method in the visual display window. This may be done by adjusting the position of the fan speed control slider to the required PWM. The duty cycle is displayed as a percentage at the bottom of the slider. The value written to the Fan Speed Config Register is displayed on the slider button.

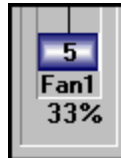

EASY SETUP

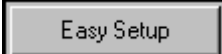
The line and bargraphs can also be started by clicking on the  button. This also sets limits for both local and remote temperature. When you click "Easy Setup" the software prompts the user to ensure that S1 and S2 are switched to AIN. This is because Easy Setup sets up the ADM1030/31 for a 2-wire fan. Easy Setup also places the ADM1030/31 under simple software control.

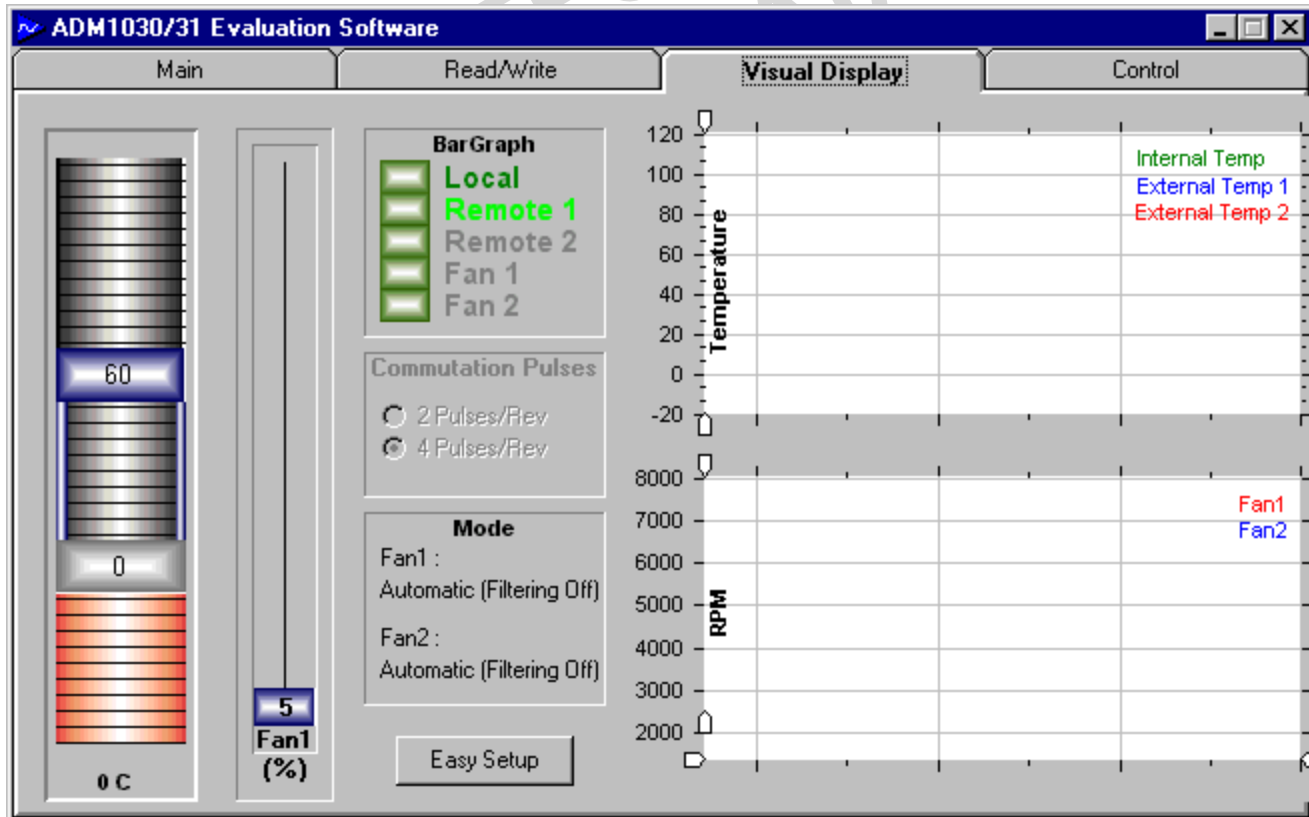

Figure6. ADM1030/31 Visual Display Program Tab

ADM1030/31 MODES OF OPERATION

The ADM1030/31 has four modes of operation. They are as follows

1. Automatic Fan Speed Control Mode
2. Filtered Automatic Fan Speed Control Mode
3. PWM Duty Cycle Select Mode
4. RPM Feedback Mode

The ADM1030/31 software allows the user to choose which mode of operation they require. It will then prompt the user to provide the information required by that particular mode of operation.

AUTOMATIC FAN SPEED CONTROL MODE.

Click on “Automatic Fan Speed Control” in the “Mode Select” window in the Control Tab. This causes the “Automatic Fan Speed Control” window to be displayed.

1. First choose which Control Operation is required, i.e. which temperature channel controls the fan.
2. Choose the necessary Tmin’s and Trange’s for the chosen Control Operation.
3. Choose the spin up times for Fan1 and if you are using the ADM1031 for Fan2 also.
4. Click on “Enable Control”
5. Automatic Fan Speed Control is enabled using the user defined parameters.

FILTERED AUTOMATIC FAN SPEED CONTROL MODE.

This mode is almost identical to the Automatic Fan Speed Control Mode. The main difference is the rate at which fan speed is ramped up after a temperature increase. Filtering is implemented by two different means, selecting the sampling rate of the ADC and ramping the fan speed to the desired speed (In Automatic Fan Speed Control Mode the fan speed is jumped immediately to the newly calculated speed). To implement Filtered Automatic Fan Speed Control click on “Filtered Automatic Control” in the “Mode Select” window of the Control Tab. This causes the “Filter Mode” window to be displayed.

1. Choose an “Increment Rate” and an “ADC Sample Rate”. See the datasheet for more information on these parameters.
2. The user may also choose to enable or disable “Fan Spin Up”
3. Finally the user is prompted to choose Automatic Fan Speed Control Parameters. This should be completed if these Parameters have not already been chosen.
4. Click on “Enable Fan Filter” to implement Filtered Automatic Fan Speed Control. (Enable Fan1 for the ADM1030 and Fan1 and Fan2 for the ADM1031)

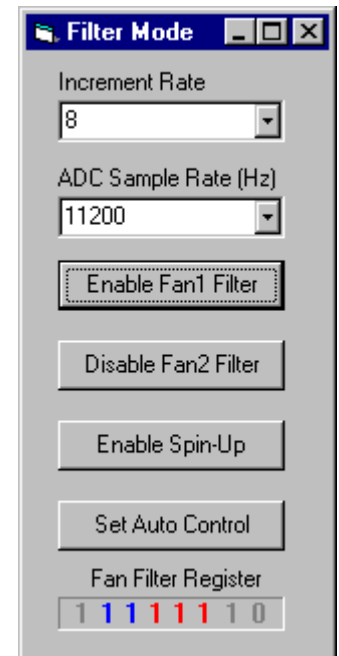
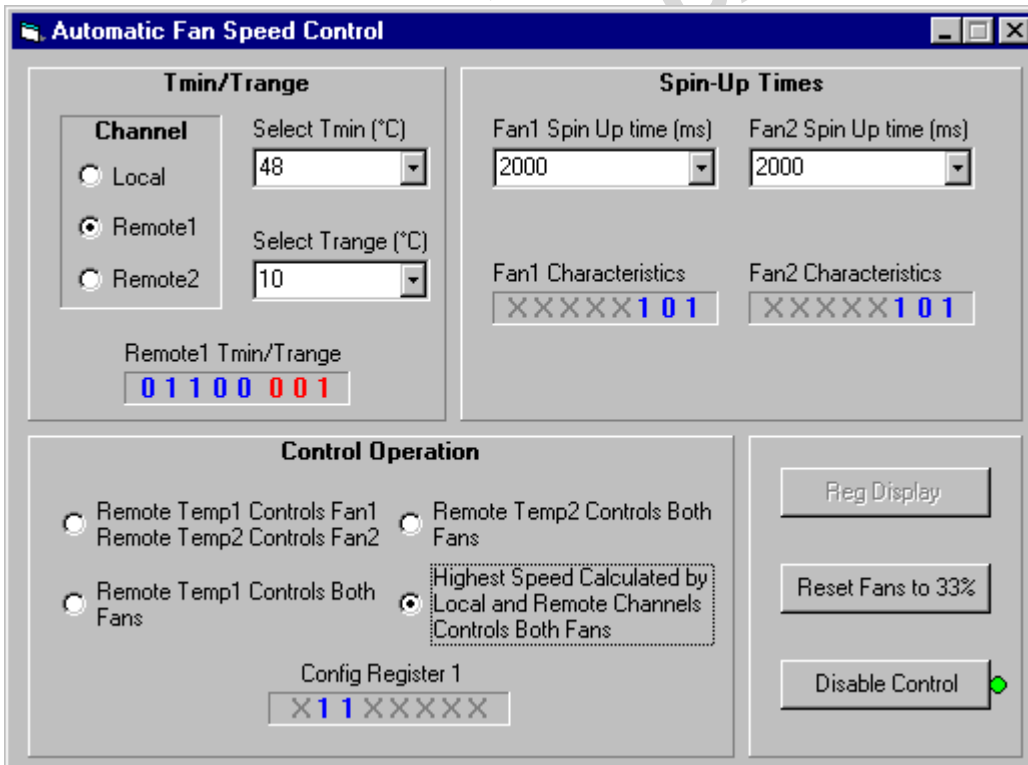

RPM CONTROL MODE

In this method of control the user programs the required RPM values to the ADM1030/31. Click on the “RPM Feedback Mode” in the “Mode Select” window of the Control Tab.

1. Enter the required RPM Value in the window.
2. Choose which fan you wish to run at that RPM value.
3. Enter the fan divisor value for that fan.
4. Click on Calculate. The software will calculate Count. This is the value that has to be written to the ADM1030/31 Tach High Limit Register to maintain the required speed. See the datasheet for an explanation of the formulas.
5. Click on “Enable RPM Mode” to place the ADM1030/31 in RPM Feedback mode.
6. Sometimes after you place a value in the “Enter RPM Mode” window and click “Calculate” the “Enable RPM Mode” button does not become active. This is because the Count value is outside the particular fan’s RPM range. The fan’s RPM range is determined by the “Fan Divisor Value”.

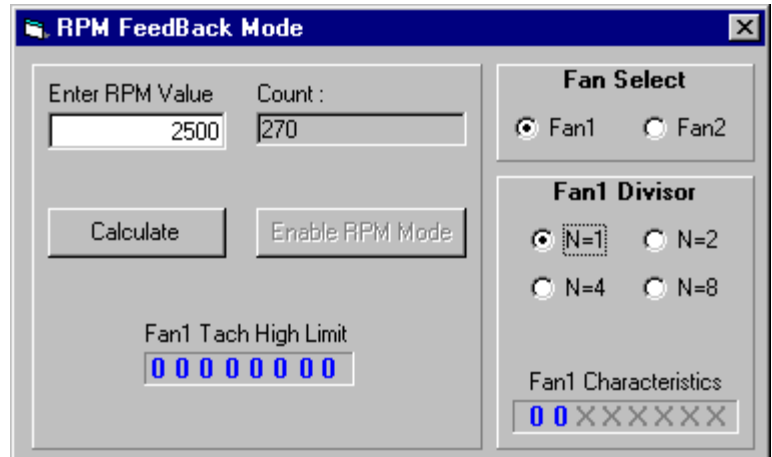

PWM DUTY CYCLE

In this method the ADM1030/31 is placed under software control. Fan speed is controlled by programming PWM values in to the ADM1030/31. Click on “PWM Duty Cycle Select” in the “Mode Select” window of the Control Tab.

1. Each fan can be programmed with a duty cycle value of between 0% and 100%.
2. Choose the required PWM value for each fan, the value chosen must be on the list in the drop down window as the ADM1030/31 can only be programmed in 6% increments.
3. Click on “Enable PWM Mode”
4. The fan/s should then either spin up or down to the programmed value.

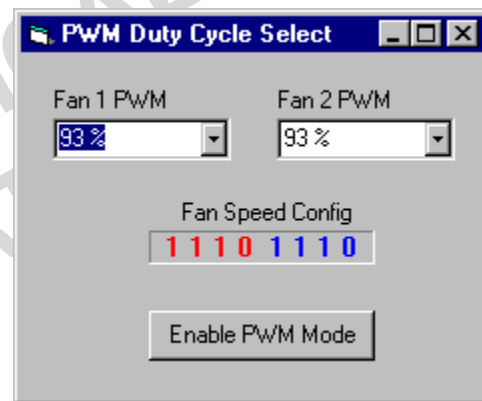

TEMPERATURE CONTROL

Temperature control allows the user to heat up the remote thermal diodes on the ADM1030/31 Evaluation Board. First choose which diode is to be monitored. Then Click on “Enable Control”. This causes a current to be switched through the two large heating resistors behind the remote thermal diodes which in turn causes the remote thermal diodes to heat up. These resistors can become very hot so care is required. Do not touch when there is a current flowing through them. Use the slider to vary the PWM duty cycle applied to the heating resistors. Adjusting the slider allows limited control of the temperature of the heating resistors.

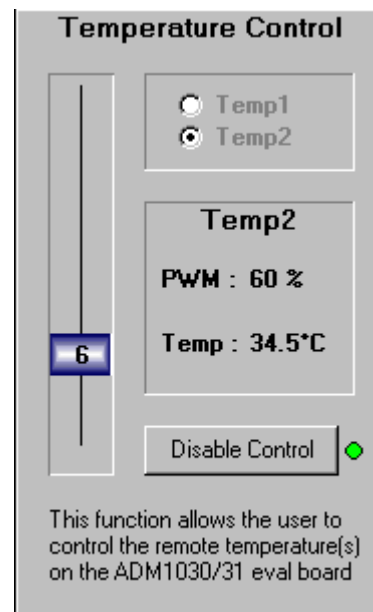

SAVING TO FILE

This window allows the user to save all the ADM1030/31 data to an Microsoft™ Excel File. The following data is saved

1. Local Temperature
2. Remote Temperature, channel 1
3. Fan Speed, channel 1, in RPM
4. Channel 1, PWM Duty Cycle
5. Remote Temperature, channel 2
6. Fan Speed, channel 2, in RPM
7. Channel 2, PWM Duty Cycle

To begin saving this data to an Excel file first click on "Make New Log". A Windows "Open File" window should open. Choose a name for the log and then click "Open". The software will then begin saving the above values to the Excel file. The user can also control how often these values are stored to the Excel file by changing the value written in the "Delay(Sec)" window. This value represents the time in seconds between successive saves. To stop saving to the Excel file the user should click on the "Logging to file" button.

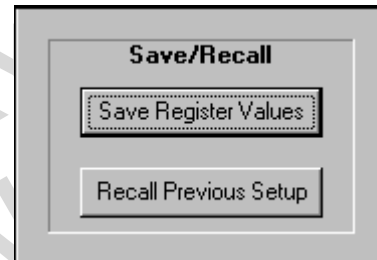
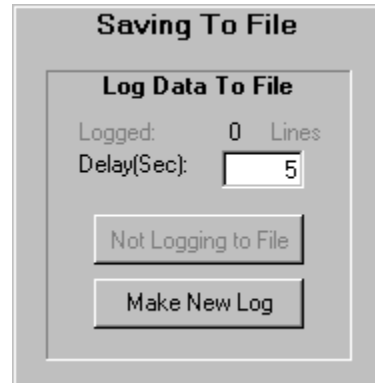

SAVE/RECALL

This window allows the user to save all the current values in the device to a .txt file. Click on "Save Register Values". This causes the Register Contents Window to be displayed. Click on "Set File Path" command. The Windows "Open" Window is then displayed. Choose a filename and Click "Open". Then Click on "Save" in the "Register Contents Window". This allows a register dump for easy writing of BIOS Software.

This window also allows the user to program all the registers with a previously saved set of values. This is achieved using the "Recall Previous Setup" Command. Click on "Recall Previous Setup" and choose the .txt filename of a previous set of register values. Then Click on "Open". These previous values are written to the registers.

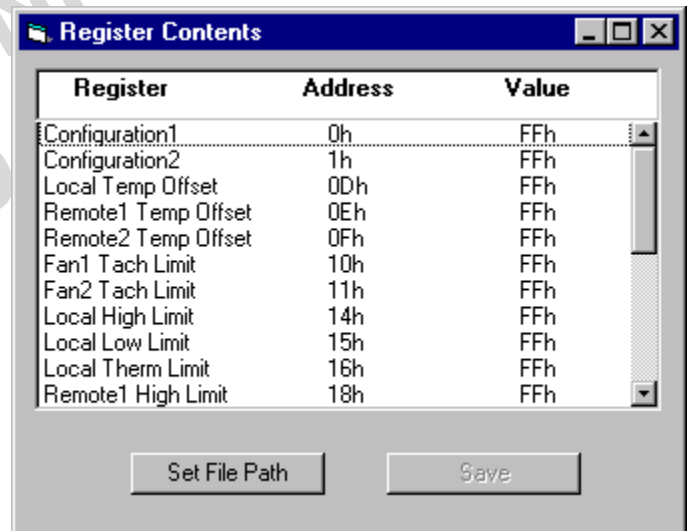

APPENDIX A. COMPONENT LIST**Capacitors**

C1-2,	0.01 μ F
C3-4, C6, C7, C9	0.1 μ F
C5, C8, C10	10 μ F

Diodes

D1, D2, D4	Red LED
D3	Green LED
D5	IN4001 Diode

Connectors

J1, J2, J8	3-pin Terminal Block
J3	Centronics Connector
J4	2-pin Terminal Block
J6	DC Barrell Connector
J7	CON\16 Header

Resistors

R1, R2	47 Ω
R3, R5, R11, R13	1k Ω
R4, R6	5 Ω
R7, R8, R14, R16	470 Ω
R9, R10, R12	2.2k Ω
R15	Wire Link
R17, R18, R19, R20	10k Ω

Switches

S1, S2	DPDT Slide Switch
S3, S4	SPDT Slide Switch
S5	SP3T Slide Switch

Semiconductors

Q1, Q2, Q5, Q6	NDT3055L
Q3, Q4	2N3904
U1	ADM1030/31ARQ
U2	74HC05
U3	CD74AC05M

Fans

LK1-A	Wire Link
Fan1, Fan2	Panasonic UDQFSDH12F