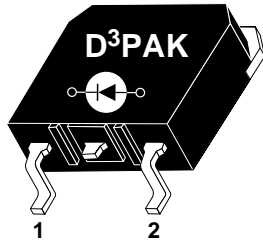


1 - Cathode  
2 - Anode  
Back of Case - Cathode



**ADVANCED  
POWER  
TECHNOLOGY®**  
APT30D60S 600V 30A

## ULTRAFAST SOFT RECOVERY RECTIFIER DIODE

### PRODUCT APPLICATIONS

- Anti-Parallel Diode
  - Switchmode Power Supply
  - Inverters
- Free Wheeling Diode
  - Motor Controllers
  - Converters
- Snubber Diode
- Uninterruptible Power Supply (UPS)
- Induction Heating
- High Speed Rectifiers

### PRODUCT FEATURES

- Ultrafast Recovery Times
- Soft Recovery Characteristics
- Surface Mount D<sup>3</sup>PAK Package
- Low Forward Voltage
- High Blocking Voltage
- Low Leakage Current

### PRODUCT BENEFITS

- Low Losses
- Low Noise Switching
- Cooler Operation
- Higher Reliability Systems
- Increased System Power Density

### MAXIMUM RATINGS

All Ratings:  $T_C = 25^\circ\text{C}$  unless otherwise specified.

Symbol	Characteristic / Test Conditions	APT30D60S	UNIT
$V_R$	Maximum D.C. Reverse Voltage	600	Volts
$V_{RRM}$	Maximum Peak Repetitive Reverse Voltage		
$V_{RWM}$	Maximum Working Peak Reverse Voltage		
$I_F(AV)$	Maximum Average Forward Current ( $T_C = 100^\circ\text{C}$ , Duty Cycle = 0.5)	30	Amps
$I_F(RMS)$	RMS Forward Current	70	
$I_{FSM}$	Non-Repetitive Forward Surge Current ( $T_J = 45^\circ\text{C}$ , 8.3ms)	320	
$T_J, T_{STG}$	Operating and Storage Temperature Range	-55 to 150	$^\circ\text{C}$
$T_L$	Lead Temperature: 0.063" from Case for 10 Sec.	300	

### STATIC ELECTRICAL CHARACTERISTICS

Symbol	Characteristic / Test Conditions	MIN	TYP	MAX	UNIT
$V_F$	Maximum Forward Voltage	$I_F = 30\text{A}$		1.8	Volts
		$I_F = 60\text{A}$		1.5	
		$I_F = 30\text{A}, T_J = 150^\circ\text{C}$		1.6	
$I_{RM}$	Maximum Reverse Leakage Current	$V_R = V_R$ Rated		250	$\mu\text{A}$
		$V_R = V_R$ Rated, $T_J = 125^\circ\text{C}$		500	
$C_T$	Junction Capacitance, $V_R = 200\text{V}$		40		pF
$L_S$	Series Inductance (Lead to Lead 5mm from Base)		10		nH

USA  
405 S.W. Columbia Street  
EUROPE

Avenue J.F. Kennedy Bât B4 Parc Cadéra Nord

APT Website - <http://www.advancedpower.com>

Bend, Oregon 97702-1035

Phone: (541) 382-8028

FAX: (541) 388-0364

F-33700 Merignac - France

Phone: (33) 5 57 92 15 15

FAX: (33) 5 56 47 97 61

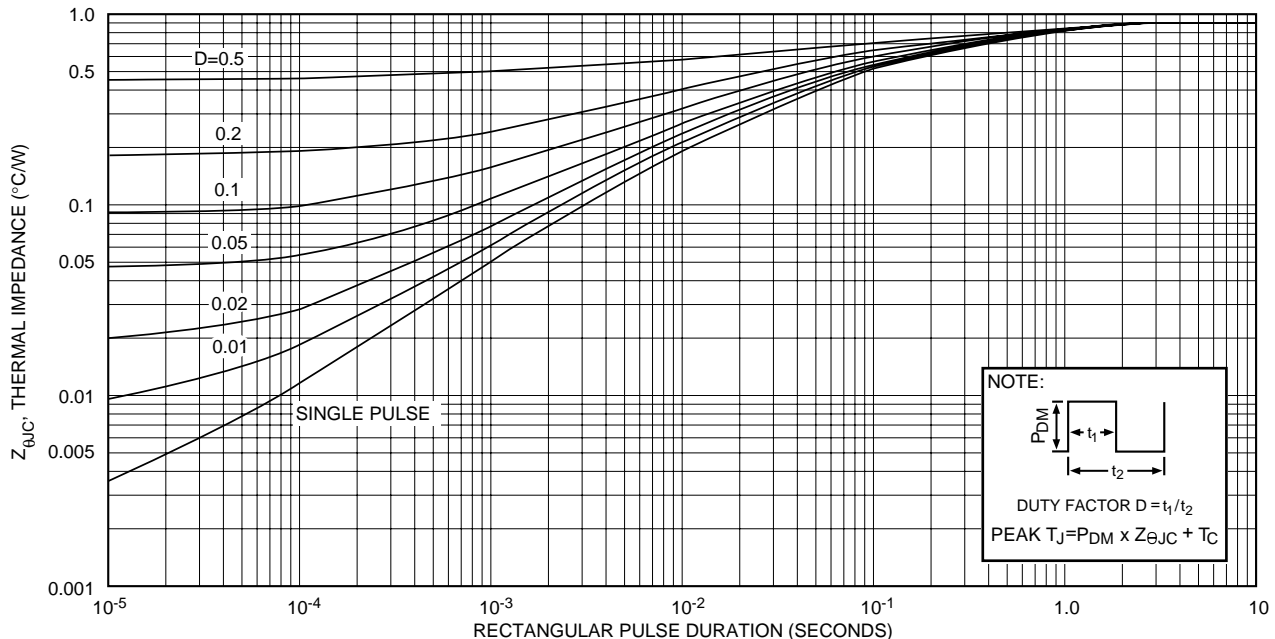
**DYNAMIC CHARACTERISTICS**

**APT30D60S**

Symbol	Characteristic	MIN	TYP	MAX	UNIT
$t_{rr1}$	Reverse Recovery Time, $I_F = 1.0A$ , $di_F/dt = -15A/\mu s$ , $V_R = 30V$ , $T_J = 25^\circ C$		50	65	ns
$t_{rr2}$	Reverse Recovery Time		50		
$t_{rr3}$	$I_F = 30A$ , $di_F/dt = -240A/\mu s$ , $V_R = 350V$		80		
$t_{fr1}$	Forward Recovery Time		155		
$t_{fr2}$	$I_F = 30A$ , $di_F/dt = 240A/\mu s$ , $V_R = 350V$		155		
$I_{RRM1}$	Reverse Recovery Current		4	10	Amps
$I_{RRM2}$	$I_F = 30A$ , $di_F/dt = -240A/\mu s$ , $V_R = 350V$		7.5	15	
$Q_{rr1}$	Recovery Charge		100		nC
$Q_{rr2}$	$I_F = 30A$ , $di_F/dt = -240A/\mu s$ , $V_R = 350V$		300		
$V_{fr1}$	Forward Recovery Voltage		5		Volts
$V_{fr2}$	$I_F = 30A$ , $di_F/dt = 240A/\mu s$ , $V_R = 350V$		5		
$diM/dt$	Rate of Fall of Recovery Current		400		A/ $\mu s$
	$I_F = 30A$ , $di_F/dt = -240A/\mu s$ , $V_R = 350V$ (See Figure 10)		200		

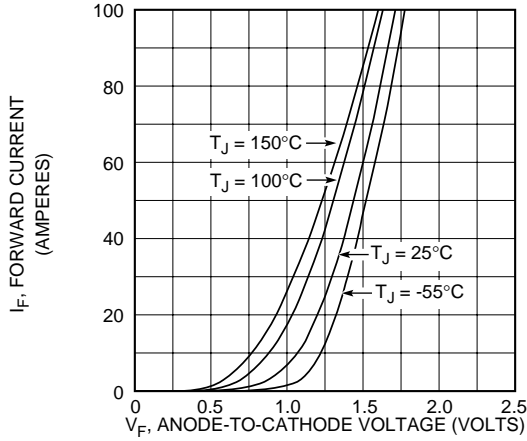
**THERMAL AND MECHANICAL CHARACTERISTICS**

Symbol	Characteristic / Test Conditions	MIN	TYP	MAX	UNIT
$R_{\theta JC}$	Junction-to-Case Thermal Resistance			0.90	$^\circ C/W$
$R_{\theta JA}$	Junction-to-Ambient Thermal Resistance			40	
$W_T$	Package Weight		0.14		oz
			3.9		gm

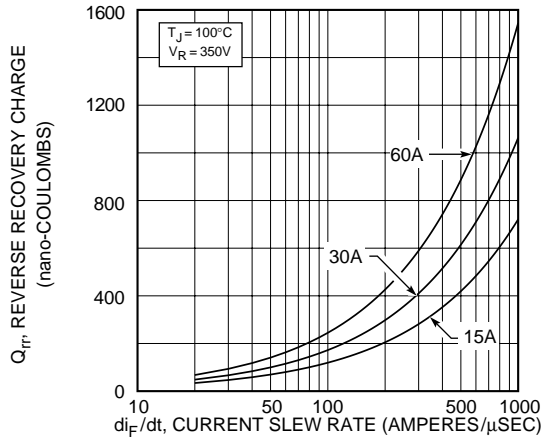


**FIGURE 1, MAXIMUM EFFECTIVE TRANSIENT THERMAL IMPEDANCE, JUNCTION-TO-CASE vs PULSE DURATION**

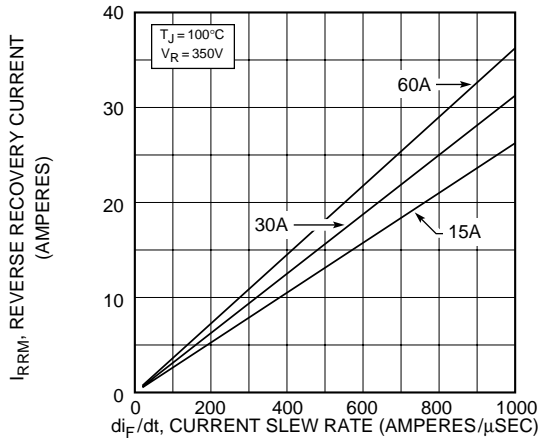
**APT30D60S**



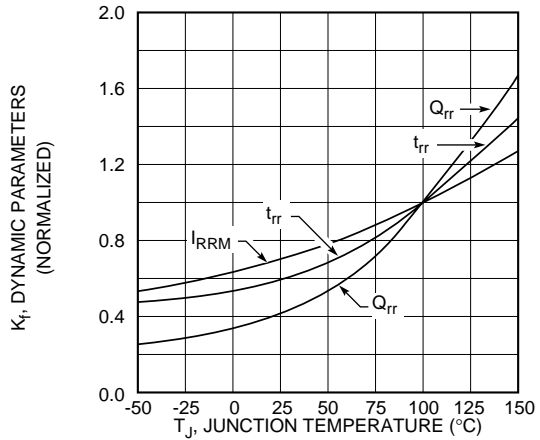
**Figure 2, Forward Voltage Drop vs Forward Current**



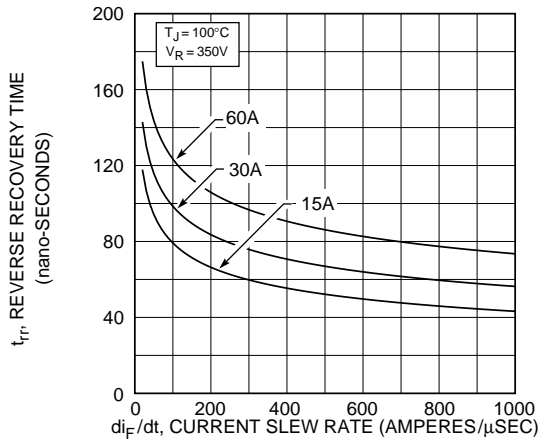
**Figure 3, Reverse Recovery Charge vs Current Slew Rate**



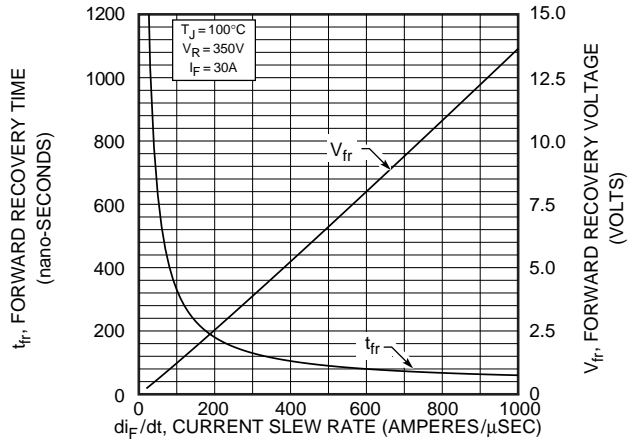
**Figure 4, Reverse Recovery Current vs Current Slew Rate**



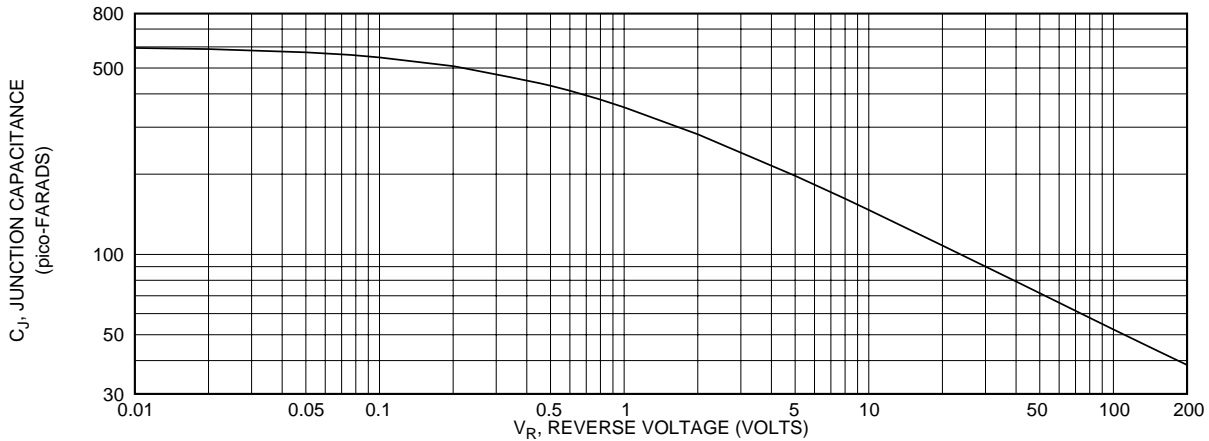
**Figure 5, Dynamic Parameters vs Junction Temperature**



**Figure 6, Reverse Recovery Time vs Current Slew Rate**



**Figure 7, Forward Recovery Voltage/Time vs Current Slew Rate**



**Figure 8, Junction Capacitance vs Reverse Voltage**

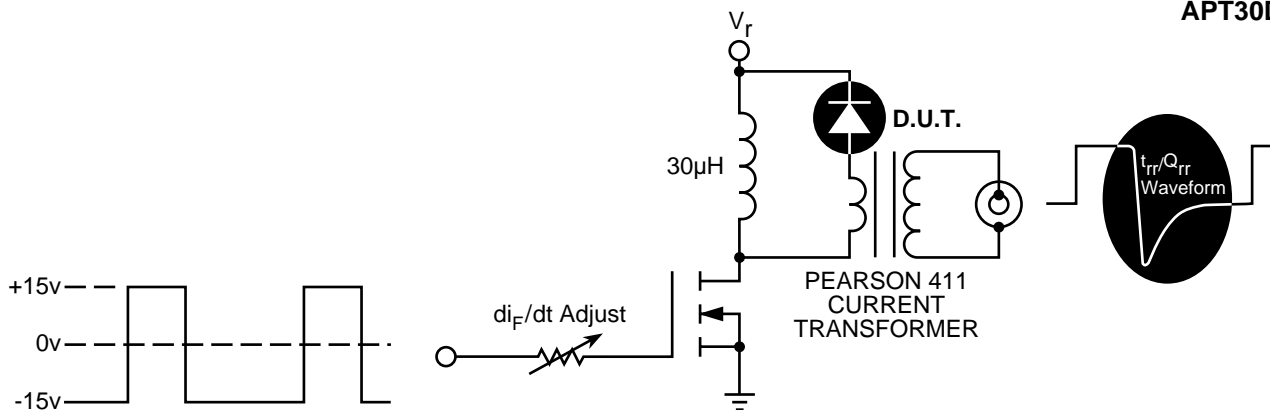


Figure 9, Diode Reverse Recovery Test Circuit and Waveforms

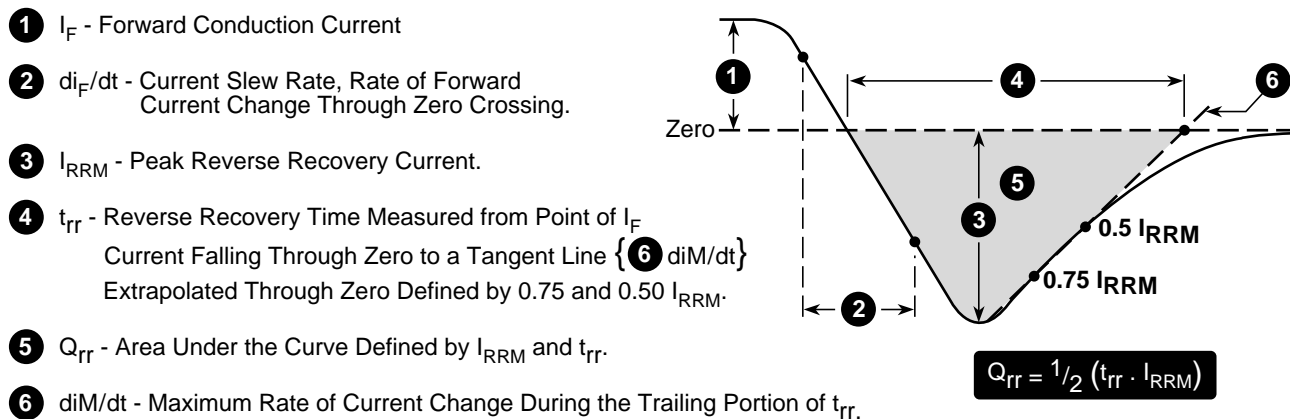
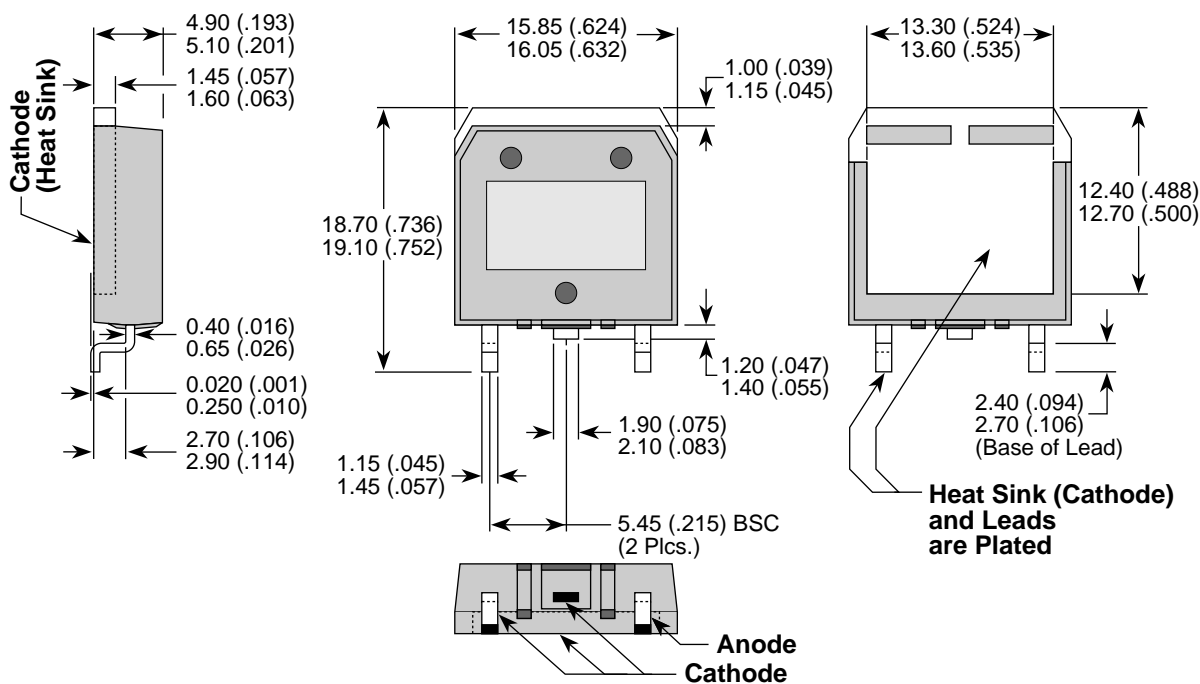


Figure 10, Diode Reverse Recovery Waveform and Definitions

APT Reserves the right to change, without notice, the specifications and information contained herein.

### D<sup>3</sup>PAK Package Outline



Dimensions in Millimeters (Inches)