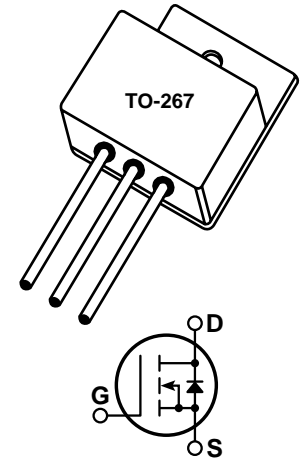


### POWER MOS V®

Power MOS V® is a new generation of high voltage N-Channel enhancement mode power MOSFETs. This new technology minimizes the JFET effect, increases packing density and reduces the on-resistance. Power MOS V® also achieves faster switching speeds through optimized gate layout.



- **Faster Switching**
- **100% Avalanche Tested**
- **Lower Leakage**
- **New TO-267 Package**

#### MAXIMUM RATINGS

All Ratings:  $T_C = 25^\circ\text{C}$  unless otherwise specified.

Symbol	Parameter	APT6017WVR	UNIT
$V_{DSS}$	Drain-Source Voltage	600	Volts
$I_D$	Continuous Drain Current @ $T_C = 25^\circ\text{C}$	31.5	Amps
$I_{DM}$	Pulsed Drain Current <sup>①</sup>	126	
$V_{GS}$	Gate-Source Voltage Continuous	$\pm 30$	Volts
$V_{GSM}$	Gate-Source Voltage Transient	$\pm 40$	
$P_D$	Total Power Dissipation @ $T_C = 25^\circ\text{C}$	450	Watts
	Linear Derating Factor	3.6	W/°C
$T_J, T_{STG}$	Operating and Storage Junction Temperature Range	-55 to 150	°C
$T_L$	Lead Temperature: 0.063" from Case for 10 Sec.	300	
$I_{AR}$	Avalanche Current <sup>①</sup> (Repetitive and Non-Repetitive)	31.5	Amps
$E_{AR}$	Repetitive Avalanche Energy <sup>①</sup>	50	mJ
$E_{AS}$	Single Pulse Avalanche Energy <sup>④</sup>	2500	

#### STATIC ELECTRICAL CHARACTERISTICS

Symbol	Characteristic / Test Conditions	MIN	TYP	MAX	UNIT
$BV_{DSS}$	Drain-Source Breakdown Voltage ( $V_{GS} = 0V, I_D = 250\mu\text{A}$ )	600			Volts
$I_{D(on)}$	On State Drain Current <sup>②</sup> ( $V_{DS} > I_{D(on)} \times R_{DS(on)}$ Max, $V_{GS} = 10V$ )	31.5			Amps
$R_{DS(on)}$	Drain-Source On-State Resistance <sup>②</sup> ( $V_{GS} = 10V, 0.5 I_{D[Cont.]}$ )			0.170	Ohms
$I_{DSS}$	Zero Gate Voltage Drain Current ( $V_{DS} = V_{DSS}, V_{GS} = 0V$ )			25	$\mu\text{A}$
	Zero Gate Voltage Drain Current ( $V_{DS} = 0.8 V_{DSS}, V_{GS} = 0V, T_C = 125^\circ\text{C}$ )			250	
$I_{GSS}$	Gate-Source Leakage Current ( $V_{GS} = \pm 30V, V_{DS} = 0V$ )			$\pm 100$	nA
$V_{GS(th)}$	Gate Threshold Voltage ( $V_{DS} = V_{GS}, I_D = 2.5\text{mA}$ )	2		4	Volts

 **CAUTION:** These Devices are Sensitive to Electrostatic Discharge. Proper Handling Procedures Should Be Followed.

**USA**  
405 S.W. Columbia Street

**EUROPE**  
Avenue J.F. Kennedy Bât B4 Parc Cadéra Nord

**APT Website - <http://www.advancedpower.com>**

Bend, Oregon 97702-1035

Phone: (541) 382-8028

FAX: (541) 388-0364

F-33700 Merignac - France

Phone: (33) 5 57 92 15 15

FAX: (33) 5 56 47 97 61

**DYNAMIC CHARACTERISTICS**

**APT6017WVR**

Symbol	Characteristic	Test Conditions	MIN	TYP	MAX	UNIT
$C_{iss}$	Input Capacitance	$V_{GS} = 0V$ $V_{DS} = 25V$ $f = 1\text{ MHz}$		7500	9000	pF
$C_{oss}$	Output Capacitance			900	1260	
$C_{rss}$	Reverse Transfer Capacitance			320	480	
$Q_g$	Total Gate Charge ③	$V_{GS} = 10V$ $V_{DD} = 0.5 V_{DSS}$ $I_D = I_{D[Cont.]} @ 25^\circ C$		315	475	nC
$Q_{gs}$	Gate-Source Charge			45	70	
$Q_{gd}$	Gate-Drain ("Miller") Charge			125	190	
$t_{d(on)}$	Turn-on Delay Time	$V_{GS} = 15V$ $V_{DD} = 0.5 V_{DSS}$ $I_D = I_{D[Cont.]} @ 25^\circ C$ $R_G = 0.6\Omega$		15	30	ns
$t_r$	Rise Time			13	26	
$t_{d(off)}$	Turn-off Delay Time			45	70	
$t_f$	Fall Time			5	10	

**SOURCE-DRAIN DIODE RATINGS AND CHARACTERISTICS**

Symbol	Characteristic / Test Conditions	MIN	TYP	MAX	UNIT
$I_S$	Continuous Source Current (Body Diode)			31.5	Amps
$I_{SM}$	Pulsed Source Current ① (Body Diode)			126	
$V_{SD}$	Diode Forward Voltage ② ( $V_{GS} = 0V, I_S = -I_{D[Cont.]}$ )			1.3	Volts
$t_{rr}$	Reverse Recovery Time ( $I_S = -I_{D[Cont.]}, di_S/dt = 100A/\mu s$ )		690		ns
$Q_{rr}$	Reverse Recovery Charge ( $I_S = -I_{D[Cont.]}, di_S/dt = 100A/\mu s$ )		15.9		$\mu C$

**THERMAL CHARACTERISTICS**

Symbol	Characteristic	MIN	TYP	MAX	UNIT
$R_{\theta JC}$	Junction to Case			0.28	$^\circ C/W$
$R_{\theta JA}$	Junction to Ambient			40	

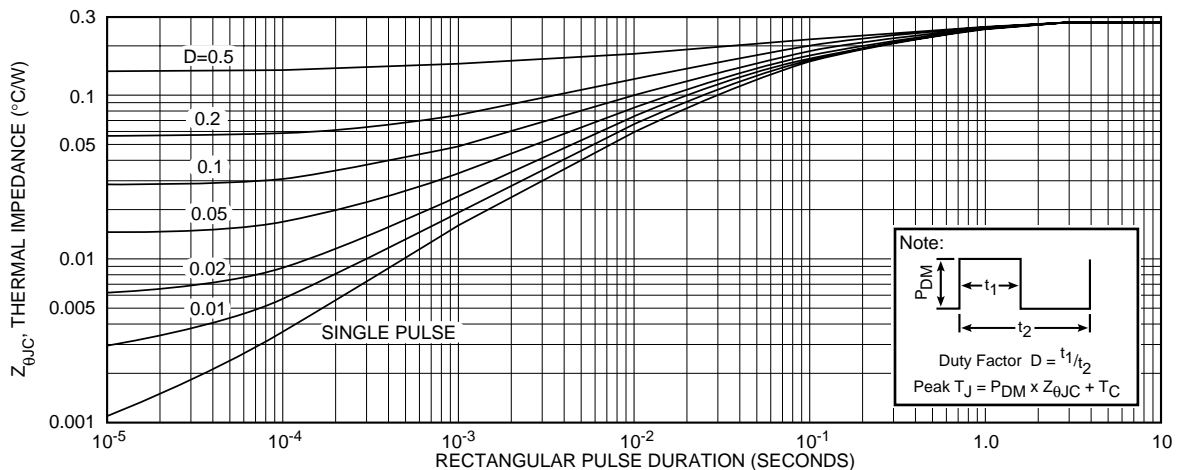
① Repetitive Rating: Pulse width limited by maximum junction temperature.

③ See MIL-STD-750 Method 3471

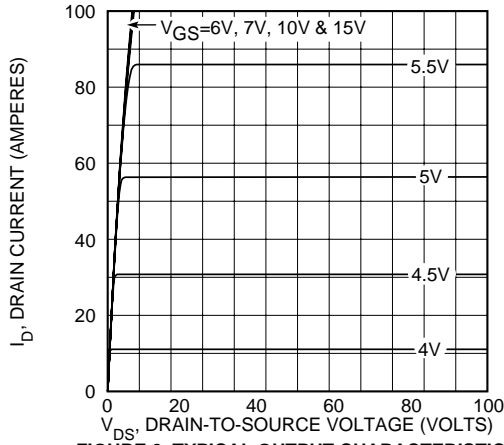
② Pulse Test: Pulse width < 380  $\mu s$ , Duty Cycle < 2%

④ Starting  $T_j = +25^\circ C$ ,  $L = 5.04mH$ ,  $R_G = 25\Omega$ , Peak  $I_L = 31.5A$

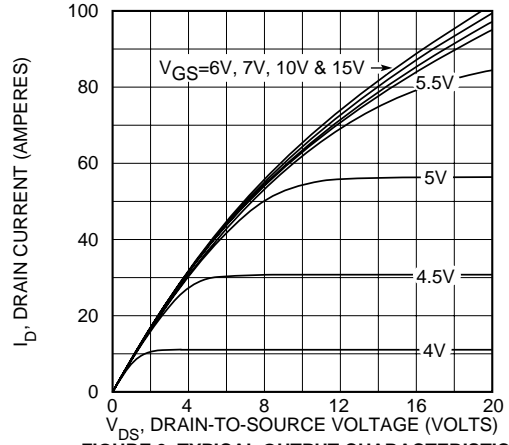
**APT Reserves the right to change, without notice, the specifications and information contained herein.**



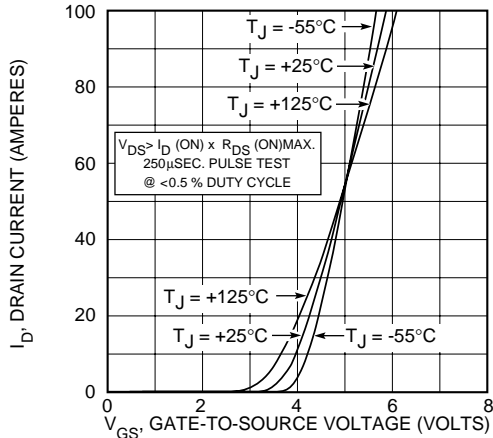
**APT6017WVR**



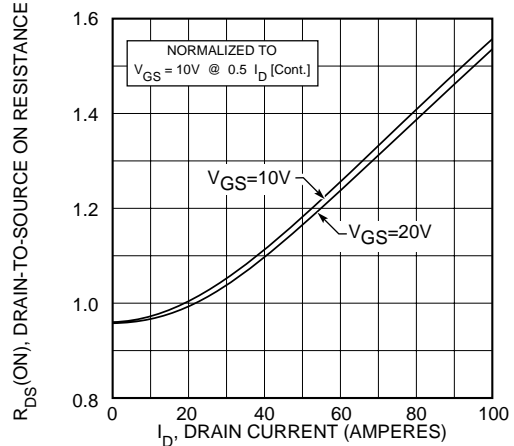
**FIGURE 2, TYPICAL OUTPUT CHARACTERISTICS**



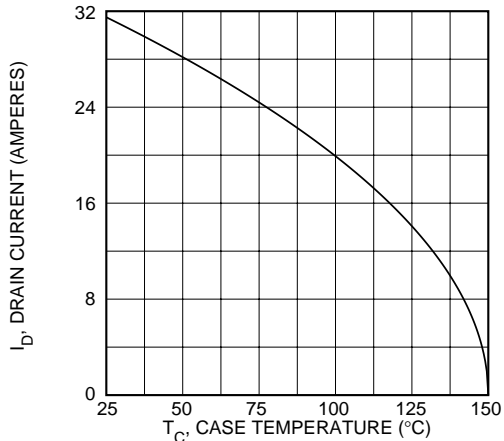
**FIGURE 3, TYPICAL OUTPUT CHARACTERISTICS**



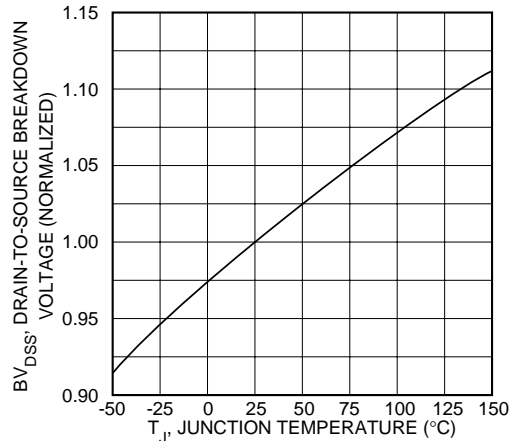
**FIGURE 4, TYPICAL TRANSFER CHARACTERISTICS**



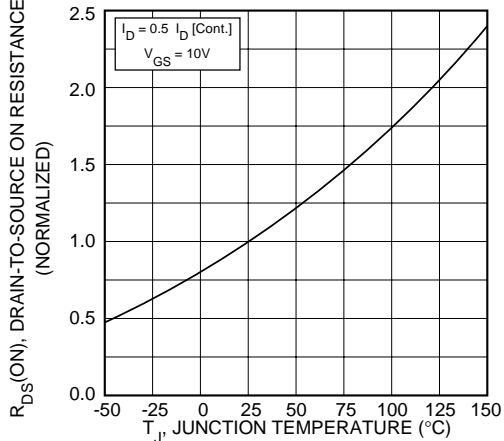
**FIGURE 5,  $R_{DS(ON)}$  vs DRAIN CURRENT**



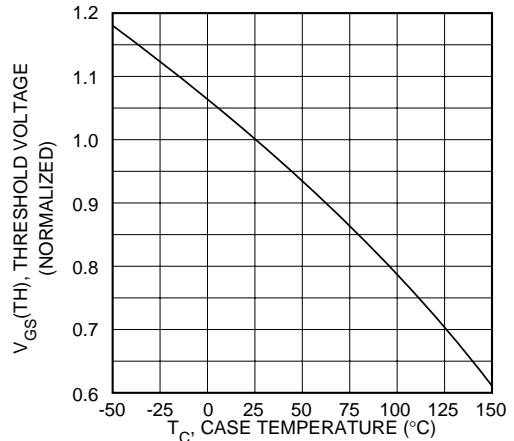
**FIGURE 6, MAXIMUM DRAIN CURRENT vs CASE TEMPERATURE**



**FIGURE 7, BREAKDOWN VOLTAGE vs TEMPERATURE**

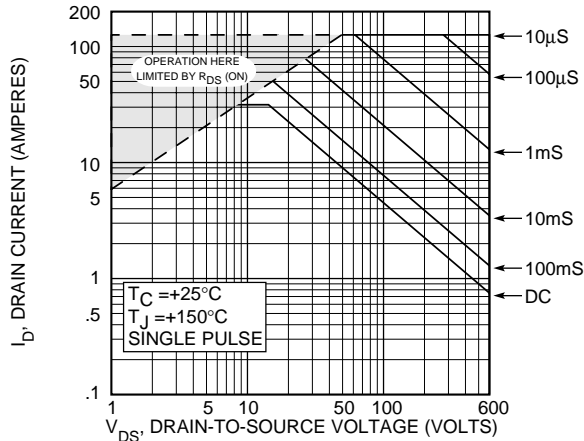


**FIGURE 8, ON-RESISTANCE vs. TEMPERATURE**

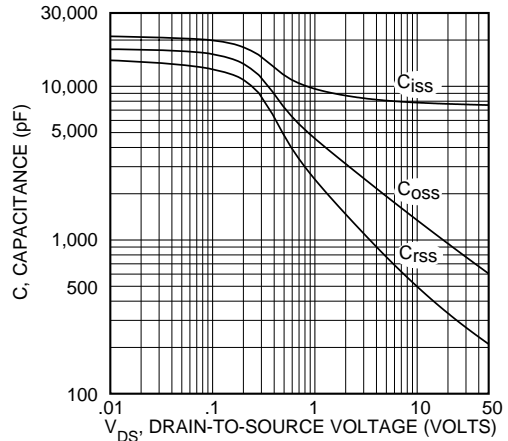


**FIGURE 9, THRESHOLD VOLTAGE vs TEMPERATURE**

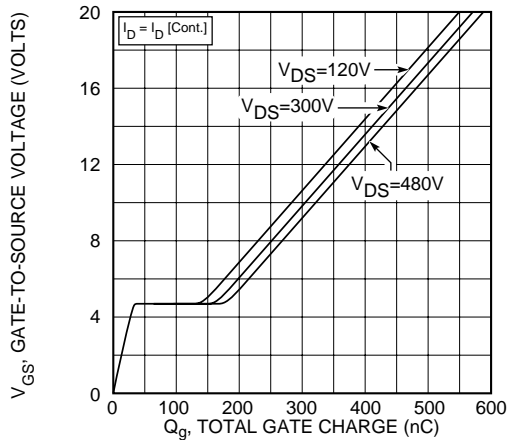
**APT6017WVR**



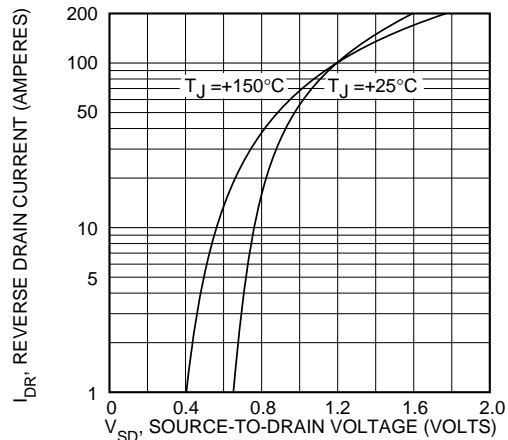
**FIGURE 10, MAXIMUM SAFE OPERATING AREA**



**FIGURE 11, TYPICAL CAPACITANCE vs DRAIN-TO-SOURCE VOLTAGE**

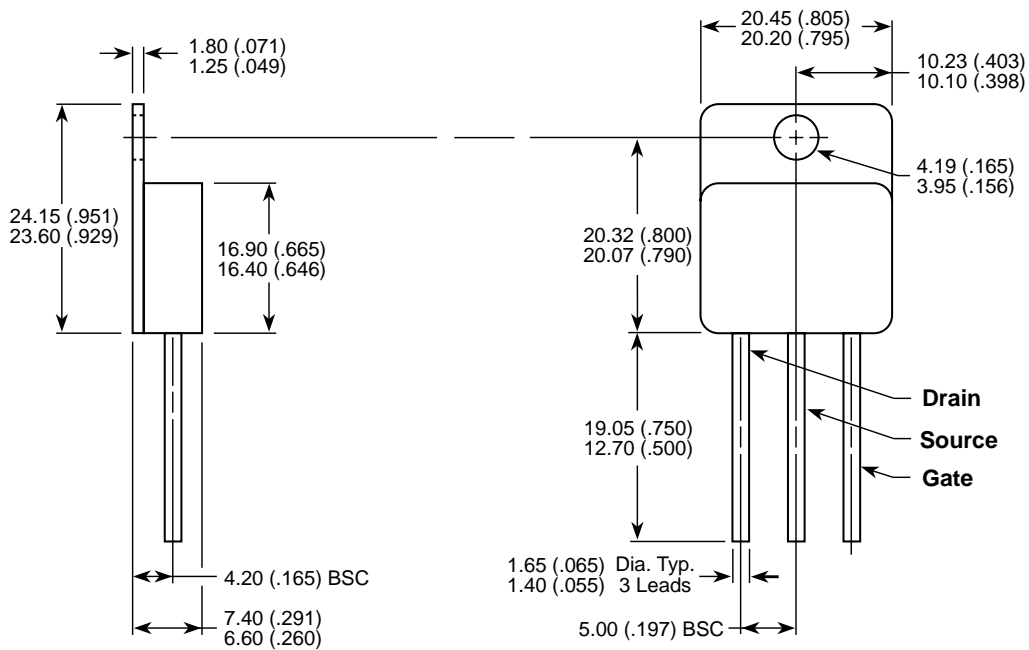


**FIGURE 12, GATE CHARGES vs GATE-TO-SOURCE VOLTAGE**



**FIGURE 13, TYPICAL SOURCE-DRAIN DIODE FORWARD VOLTAGE**

**TO-267 Package Outline**



Dimensions in Millimeters and (Inches)