

APT4020BN 400V 26.0A 0.20Ω

APT4025BN 400V 23.0A 0.25Ω

POWER MOS IV®

N-CHANNEL ENHANCEMENT MODE HIGH VOLTAGE POWER MOSFETS

MAXIMUM RATINGS

All Ratings: $T_C = 25^\circ\text{C}$ unless otherwise specified.

| Symbol | Parameter | APT 4020BN | APT 4025BN | UNIT |
|----------------|---|------------|------------|-------|
| V_{DSS} | Drain-Source Voltage | 400 | 400 | Volts |
| I_D | Continuous Drain Current @ $T_C = 25^\circ\text{C}$ | 26 | 23 | Amps |
| I_{DM} | Pulsed Drain Current ^① | 104 | 92 | |
| V_{GS} | Gate-Source Voltage | ± 30 | | Volts |
| P_D | Total Power Dissipation @ $T_C = 25^\circ\text{C}$ | 310 | | Watts |
| | Linear Derating Factor | 2.48 | | W/°C |
| T_J, T_{STG} | Operating and Storage Junction Temperature Range | -55 to 150 | | °C |
| T_L | Lead Temperature: 0.063" from Case for 10 Sec. | 300 | | |

STATIC ELECTRICAL CHARACTERISTICS

| Symbol | Characteristic / Test Conditions / Part Number | MIN | TYP | MAX | UNIT |
|--------------|---|-----------|-----|-----------|---------------|
| BV_{DSS} | Drain-Source Breakdown Voltage ($V_{GS} = 0V, I_D = 250 \mu\text{A}$) | APT4020BN | 400 | | Volts |
| | | APT4025BN | 400 | | |
| $I_{D(ON)}$ | On State Drain Current ^② ($V_{DS} > I_{D(ON)} \times R_{DS(ON)}$ Max, $V_{GS} = 10V$) | APT4020BN | 26 | | Amps |
| | | APT4025BN | 23 | | |
| $R_{DS(ON)}$ | Drain-Source On-State Resistance ^② ($V_{GS} = 10V, 0.5 I_D$ [Cont.]) | APT4020BN | | 0.20 | Ohms |
| | | APT4025BN | | 0.25 | |
| I_{DSS} | Zero Gate Voltage Drain Current ($V_{DS} = V_{DSS}, V_{GS} = 0V$) | | | 250 | μA |
| | Zero Gate Voltage Drain Current ($V_{DS} = 0.8 V_{DSS}, V_{GS} = 0V, T_C = 125^\circ\text{C}$) | | | 1000 | |
| I_{GSS} | Gate-Source Leakage Current ($V_{GS} = \pm 30V, V_{DS} = 0V$) | | | ± 100 | nA |
| $V_{GS(TH)}$ | Gate Threshold Voltage ($V_{DS} = V_{GS}, I_D = 1.0\text{mA}$) | 2 | | 4 | Volts |

THERMAL CHARACTERISTICS

| Symbol | Characteristic | MIN | TYP | MAX | UNIT |
|-----------------|---------------------|-----|-----|------|------|
| $R_{\theta JC}$ | Junction to Case | | | 0.40 | °C/W |
| $R_{\theta JA}$ | Junction to Ambient | | | 40 | |

CAUTION: These Devices are Sensitive to Electrostatic Discharge. Proper Handling Procedures Should Be Followed.

USA

405 S.W. Columbia Street

EUROPE

Avenue J.F. Kennedy Bât B4 Parc Cadéra Nord

Bend, Oregon 97702-1035

F-33700 Merignac - France

Phone: (541) 382-8028

Phone: (33) 5 57 92 15 15

FAX: (541) 388-0364

FAX: (33) 5 56 47 97 61

DYNAMIC CHARACTERISTICS

APT4020/4025BN

| Symbol | Characteristic | Test Conditions | MIN | TYP | MAX | UNIT |
|-------------------|------------------------------|--|-----|------|------|------|
| C_{iss} | Input Capacitance | $V_{GS} = 0V$ $V_{DS} = 25V$ $f = 1 \text{ MHz}$ | | 2380 | 2950 | pF |
| C_{oss} | Output Capacitance | | | 563 | 750 | |
| C_{rss} | Reverse Transfer Capacitance | | | 207 | 310 | |
| Q_g | Total Gate Charge ③ | $V_{GS} = 10V$ $V_{DD} = 0.5 V_{DSS}$ $I_D = I_D [\text{Cont.}] @ 25^\circ\text{C}$ | | 94 | 130 | nC |
| Q_{gs} | Gate-Source Charge | | | 11 | 16 | |
| Q_{gd} | Gate-Drain ("Miller") Charge | | | 47 | 70 | |
| $t_d(\text{on})$ | Turn-on Delay Time | $V_{GS} = 15V$ $V_{DD} = 0.5 V_{DSS}$ $I_D = I_D [\text{Cont.}] @ 25^\circ\text{C}$ $R_G = 1.8\Omega$ | | 14 | 28 | ns |
| t_r | Rise Time | | | 29 | 57 | |
| $t_d(\text{off})$ | Turn-off Delay Time | | | 60 | 90 | |
| t_f | Fall Time | | | 40 | 80 | |

SOURCE-DRAIN DIODE RATINGS AND CHARACTERISTICS

| Symbol | Characteristic / Test Conditions / Part Number | MIN | TYP | MAX | UNIT |
|----------|---|-----------|-----|-----|---------------|
| I_S | Continuous Source Current (Body Diode) | APT4020BN | | 26 | Amps |
| | | APT4025BN | | 23 | |
| I_{SM} | Pulsed Source Current ① (Body Diode) | APT4020BN | | 104 | Amps |
| | | APT4025BN | | 92 | |
| V_{SD} | Diode Forward Voltage ② ($V_{GS} = 0V, I_S = -I_D [\text{Cont.}]$) | | | 1.3 | Volts |
| t_{rr} | Reverse Recovery Time ($I_S = -I_D [\text{Cont.}], di_S/dt = 100A/\mu s$) | | 360 | 720 | ns |
| Q_{rr} | Reverse Recovery Charge ($I_S = -I_D [\text{Cont.}], di_S/dt = 100A/\mu s$) | | 6 | 12 | μC |

SAFE OPERATING AREA CHARACTERISTICS

| Symbol | Characteristic | Test Conditions / Part Number | MIN | TYP | MAX | UNIT |
|----------|---------------------------|--|-----|-----|-----|-------|
| SOA1 | Safe Operating Area | $V_{DS} = 0.4 V_{DSS}, I_{DS} = P_D / 0.4 V_{DSS}, t = 1 \text{ Sec.}$ | 310 | | | Watts |
| SOA2 | Safe Operating Area | $I_{DS} = I_D [\text{Cont.}], V_{DS} = P_D / I_D [\text{Cont.}], t = 1 \text{ Sec.}$ | 310 | | | |
| I_{LM} | Inductive Current Clamped | APT4020BN | 104 | | | Amps |
| | | APT4025BN | 92 | | | |

① Repetitive Rating: Pulse width limited by maximum junction temperature. See Transient Thermal Impedance Curve. (Fig.1)

② Pulse Test: Pulse width < 380 μs , Duty Cycle < 2%

③ See MIL-STD-750 Method 3471

APT Reserves the right to change, without notice, the specifications and information contained herein.

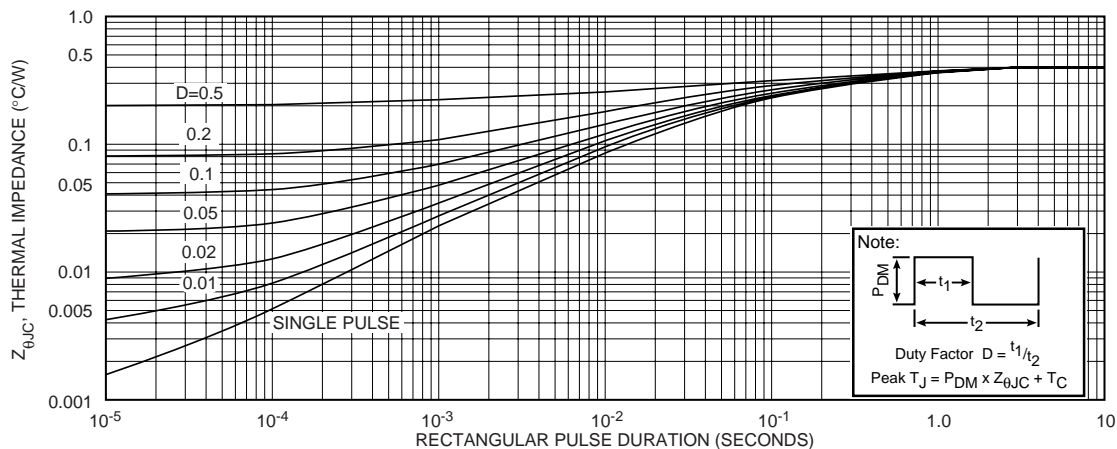

FIGURE 1, MAXIMUM EFFECTIVE TRANSIENT THERMAL IMPEDANCE, JUNCTION-TO-CASE vs PULSE DURATION

APT4020/4025BN

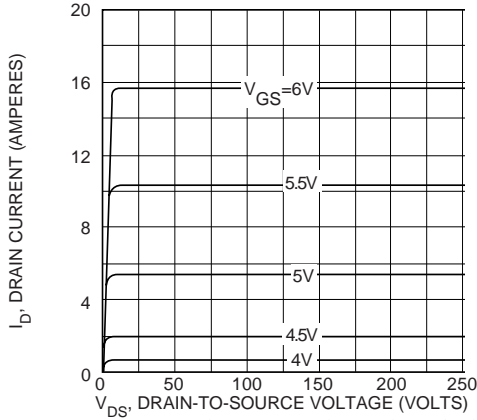

FIGURE 2, TYPICAL OUTPUT CHARACTERISTICS

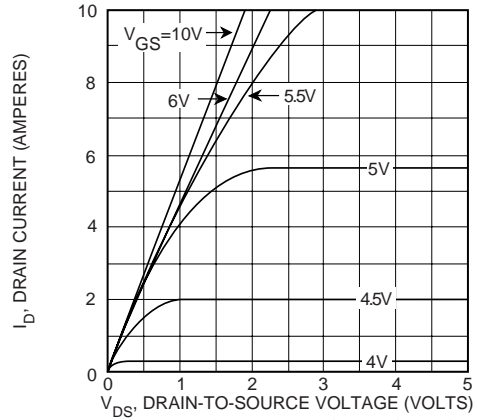

FIGURE 3, TYPICAL OUTPUT CHARACTERISTICS

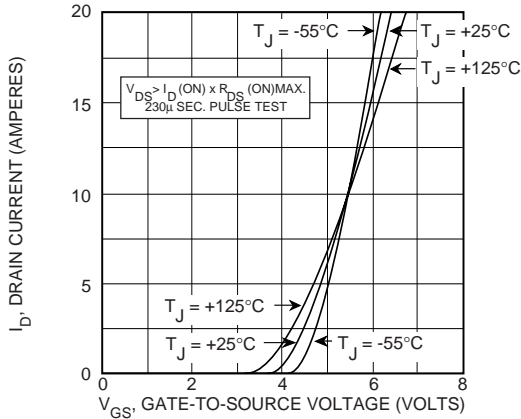

FIGURE 4, TYPICAL TRANSFER CHARACTERISTICS

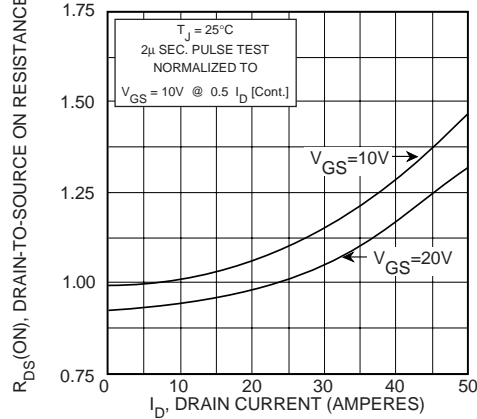

FIGURE 5, $R_{DS(ON)}$ vs DRAIN CURRENT

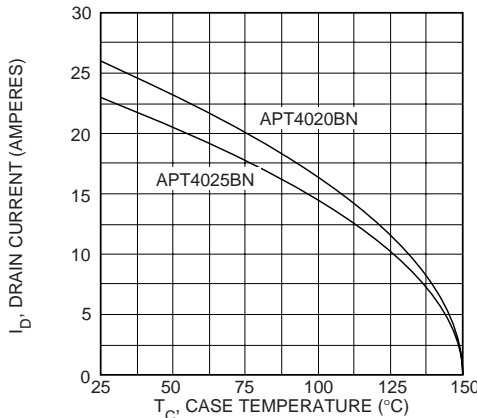

FIGURE 6, MAXIMUM DRAIN CURRENT vs CASE TEMPERATURE

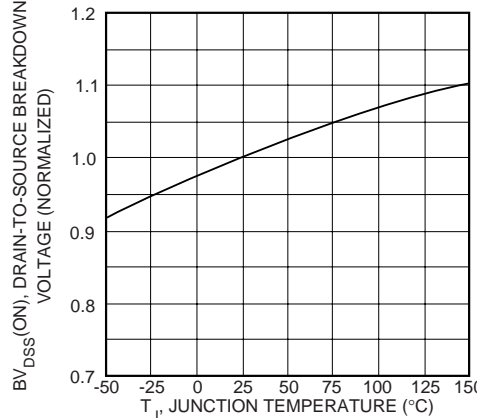

FIGURE 7, BREAKDOWN VOLTAGE vs TEMPERATURE

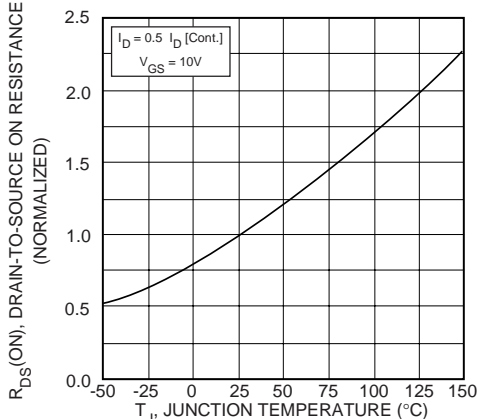

FIGURE 8, ON-RESISTANCE vs. TEMPERATURE

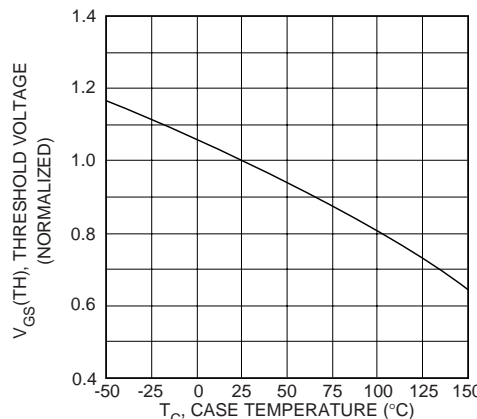

FIGURE 9, THRESHOLD VOLTAGE vs TEMPERATURE

APT4020/4025BN

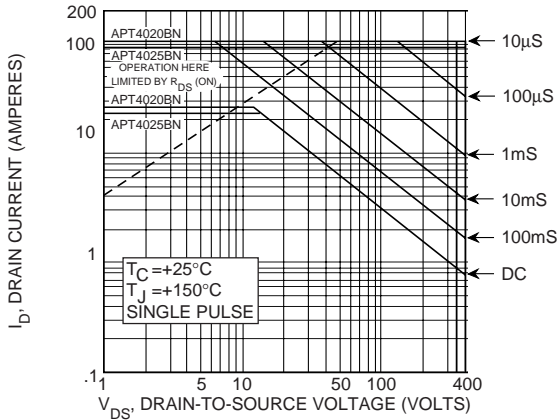

FIGURE 10, MAXIMUM SAFE OPERATING AREA

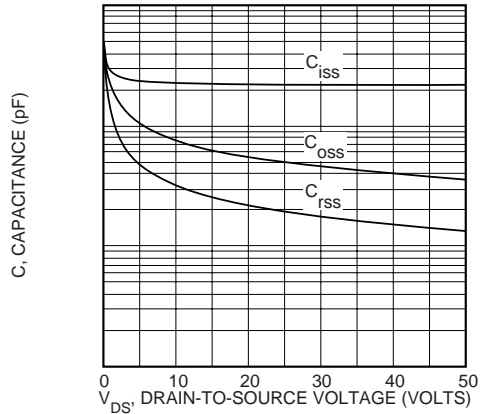

FIGURE 11, TYPICAL CAPACITANCE vs DRAIN-TO-SOURCE VOLTAGE

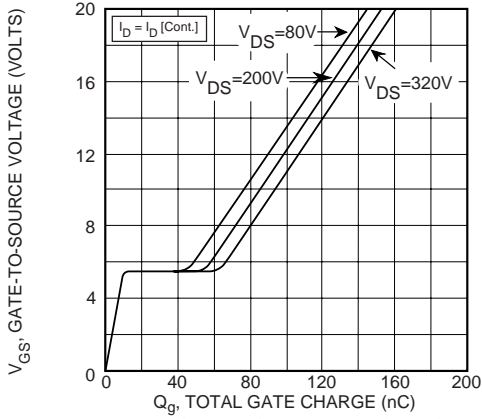

FIGURE 12, GATE CHARGES vs GATE-TO-SOURCE VOLTAGE

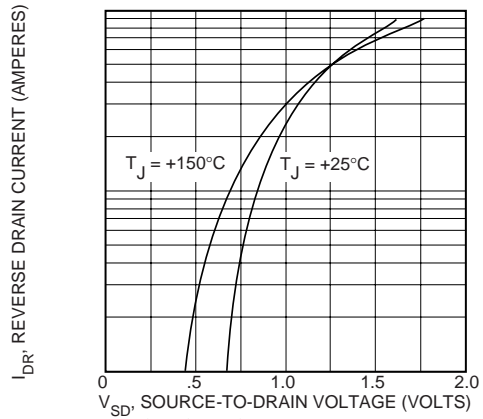
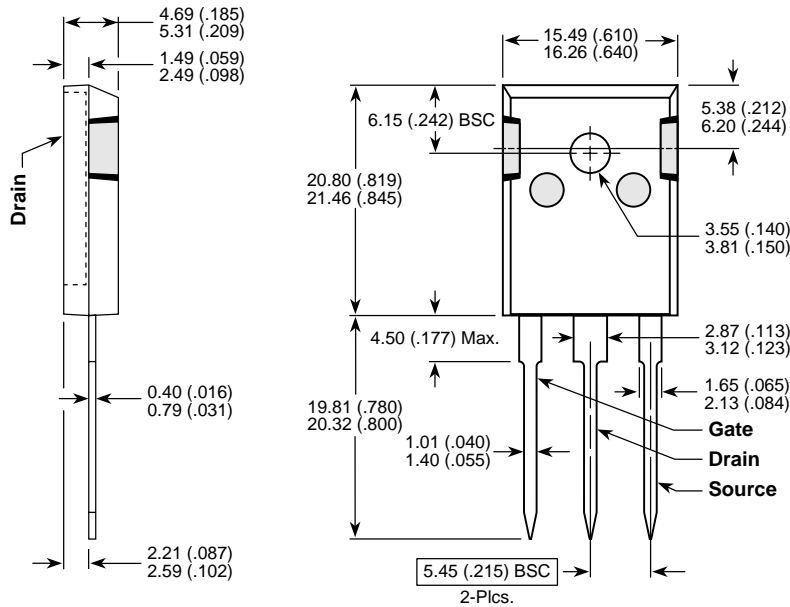

FIGURE 13, TYPICAL SOURCE-DRAIN DIODE FORWARD VOLTAGE

TO-247AD Package Outline



Dimensions in Millimeters and (Inches)