

APT4030CNR 400V 15.0A 0.300Ω

POWER MOS IV™ Avalanche Rated

N - CHANNEL ENHANCEMENT MODE HIGH VOLTAGE POWER MOSFETS

- **Faster Switching** • **100% Avalanche Tested** • **Popular TO-254 Package**
- **Low Gate Charge** • **Similar to the 2N7227, JX2N7227 and JV2N7227**

MAXIMUM RATINGS

All Ratings: $T_C = 25^\circ\text{C}$ unless otherwise specified.

Symbol	Parameter	APT4030CNR	UNIT
V_{DSS}	Drain-Source Voltage	400	Volts
I_D	Continuous Drain Current @ $T_C = 25^\circ\text{C}$	15	Amps
I_{DM}	Pulsed Drain Current ^①	60	
V_{GS}	Gate-Source Voltage Continuous	± 30	Volts
V_{GSM}	Gate-Source Voltage Transient	± 40	
P_D	Total Power Dissipation @ $T_C = 25^\circ\text{C}$	150	Watts
	Linear Derating Factor	1.2	W/ $^\circ\text{C}$
T_J, T_{STG}	Operating and Storage Junction Temperature Range	-55 to 150	$^\circ\text{C}$
T_L	Lead Temperature: 0.063" from Case for 10 Sec.	300	
I_{AR}	Avalanche Current ^① (Repetitive and Non-Repetitive)	15	Amps
E_{AR}	Repetitive Avalanche Energy ^①	20	mJ
E_{AS}	Single Pulse Avalanche Energy ^③	800	

STATIC ELECTRICAL CHARACTERISTICS

Symbol	Characteristic / Test Conditions	MIN	TYP	MAX	UNIT
BV_{DSS}	Drain-Source Breakdown Voltage ($V_{GS} = 0V, I_D = 250\mu\text{A}$)	400			Volts
$I_{D(on)}$	On State Drain Current ^② ($V_{DS} > I_{D(on)} \times R_{DS(on)}$ Max, $V_{GS} = 10V$)	15			Amps
$R_{DS(on)}$	Drain-Source On-State Resistance ^② ($V_{GS} = 10V, 0.5 I_{D[Cont.]}$)			0.30	Ohms
I_{DSS}	Zero Gate Voltage Drain Current ($V_{DS} = V_{DSS}, V_{GS} = 0V$)			250	μA
	Zero Gate Voltage Drain Current ($V_{DS} = 0.8 V_{DSS}, V_{GS} = 0V, T_C = 125^\circ\text{C}$)			1000	
I_{GSS}	Gate-Source Leakage Current ($V_{GS} = \pm 30V, V_{DS} = 0V$)			± 100	nA
$V_{GS(th)}$	Gate Threshold Voltage ($V_{DS} = V_{GS}, I_D = 1.0\text{mA}$)	2		4	Volts

CAUTION: These Devices are Sensitive to Electrostatic Discharge. Proper Handling Procedures Should Be Followed.

APT Website - <http://www.advancedpower.com>

USA
405 S.W. Columbia Street

Bend, Oregon 97702-1035

Phone: (541) 382-8028

FAX: (541) 388-0364

EUROPE

Avenue J.F. Kennedy Bât B4 Parc Cadéra Nord

F-33700 Merignac - France

Phone: (33) 5 57 92 15 15

FAX: (33) 5 56 47 97 61

DYNAMIC CHARACTERISTICS

APT4030CNR

Symbol	Characteristic	Test Conditions	MIN	TYP	MAX	UNIT
C_{DC}	Drain-to-Case Capacitance	$f = 1 \text{ MHz}$		15	22	pF
C_{iss}	Input Capacitance	$V_{GS} = 0V$		1500	1800	
C_{oss}	Output Capacitance	$V_{DS} = 25V$		385	540	
C_{rss}	Reverse Transfer Capacitance	$f = 1 \text{ MHz}$		160	240	
Q_g	Total Gate Charge	$V_{GS} = 10V$		71	105	nC
Q_{gs}	Gate-Source Charge	$V_{DD} = 0.5 V_{DSS}$		8	12	
Q_{gd}	Gate-Drain ("Miller") Charge	$I_D = I_D [\text{Cont.}] @ 25^\circ\text{C}$		36	54	
$t_{d(on)}$	Turn-on Delay Time	$V_{GS} = 10V$		14	28	ns
t_r	Rise Time	$V_{DD} = 0.5 V_{DSS}$		23	46	
$t_{d(off)}$	Turn-off Delay Time	$I_D = I_D [\text{Cont.}] @ 25^\circ\text{C}$		43	64	
t_f	Fall Time	$R_G = 1.80\Omega$		15	30	

SOURCE-DRAIN DIODE RATINGS AND CHARACTERISTICS

Symbol	Characteristic / Test Conditions	MIN	TYP	MAX	UNIT
I_S	Continuous Source Current (Body Diode)			15	Amps
I_{SM}	Pulsed Source Current ^① (Body Diode)			60	
V_{SD}	Diode Forward Voltage ^② ($V_{GS} = 0V, I_S = -I_D [\text{Cont.}]$)			1.3	Volts
t_{rr}	Reverse Recovery Time ($I_S = -I_D [\text{Cont.}], di_S/dt = 100A/\mu s$)		284	568	ns
Q_{rr}	Reverse Recovery Charge ($I_S = -I_D [\text{Cont.}], di_S/dt = 100A/\mu s$)		4.5	9.0	μC

THERMAL CHARACTERISTICS

Symbol	Characteristic	MIN	TYP	MAX	UNIT
$R_{\theta JC}$	Junction to Case			0.80	W/ $^\circ\text{C}$
$R_{\theta JA}$	Junction to Ambient			50	

① Repetitive Rating: Pulse width limited by maximum junction temperature. See Transient Thermal Impedance Curve. (Fig.1)

② Pulse Test: Pulse width < 380 μs , Duty Cycle < 2%

③ Starting $T_J = +25^\circ\text{C}$, $L = 7.11\text{mH}$, $R_G = 25\Omega$, Peak $I_L = 15A$

APT Reserves the right to change, without notice, the specifications and information contained herein.

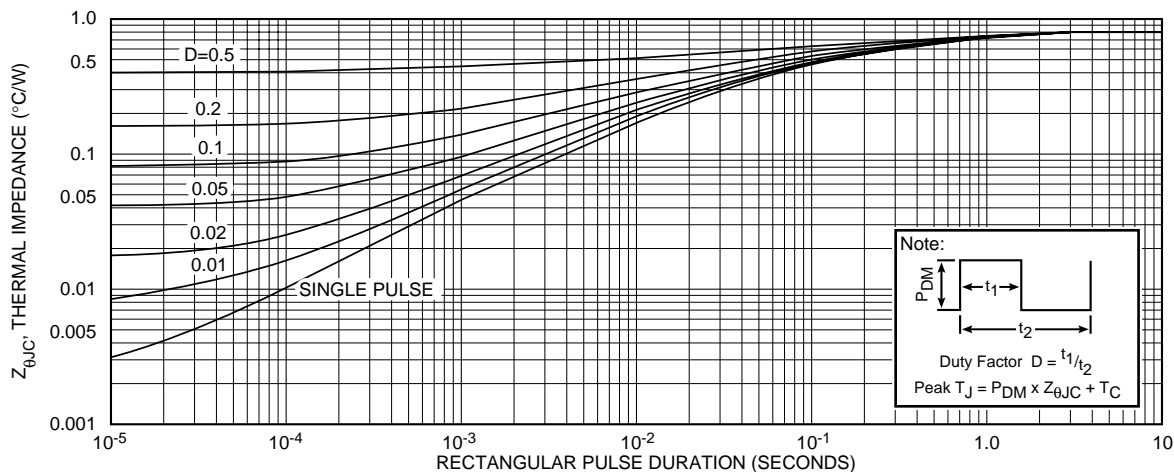

FIGURE 1, MAXIMUM EFFECTIVE TRANSIENT THERMAL IMPEDANCE, JUNCTION-TO-CASE vs PULSE DURATION

APT4030CNR

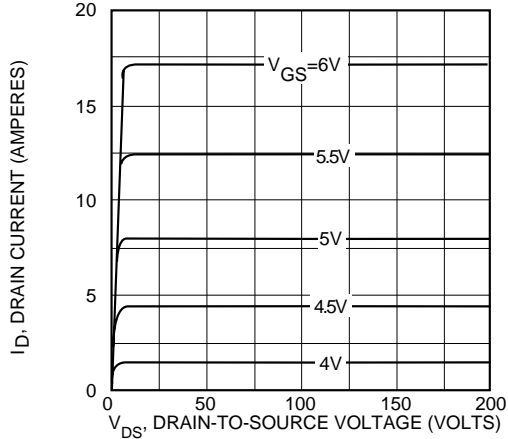

FIGURE 2, TYPICAL OUTPUT CHARACTERISTICS

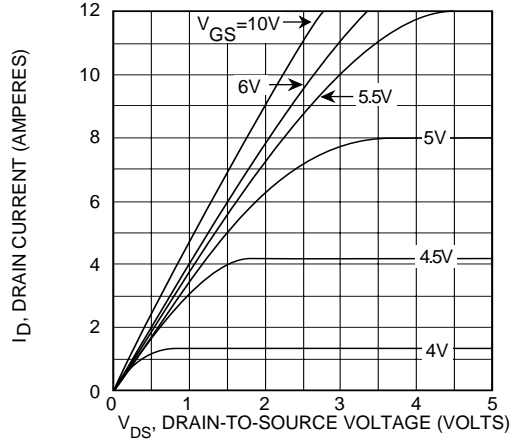

FIGURE 3, TYPICAL OUTPUT CHARACTERISTICS

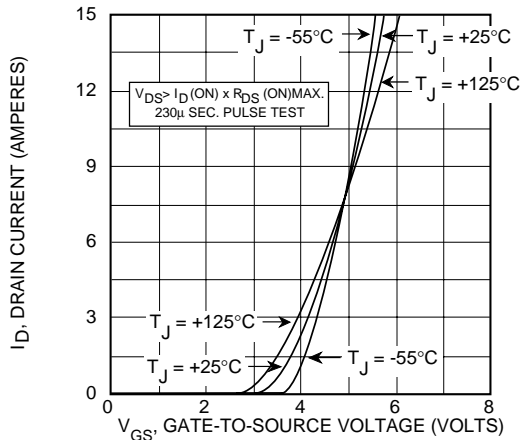

FIGURE 4, TYPICAL TRANSFER CHARACTERISTICS

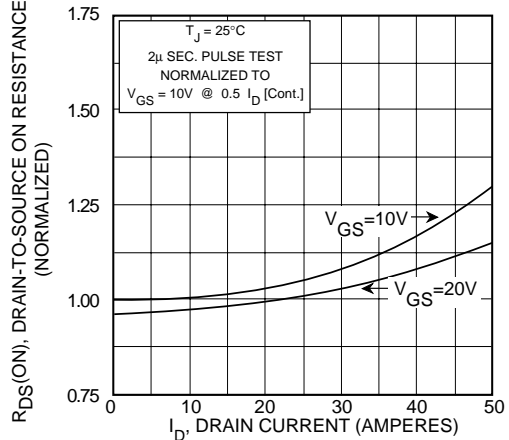

FIGURE 5, $R_{DS(ON)}$ vs DRAIN CURRENT

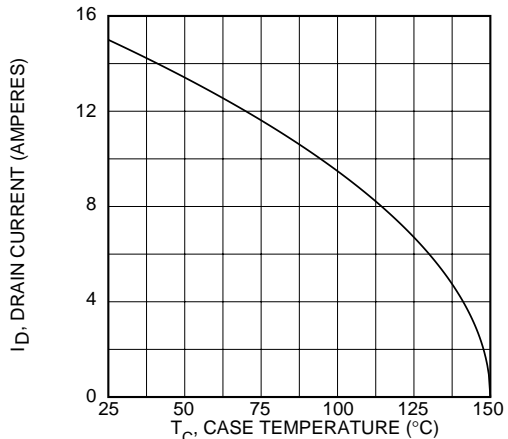

FIGURE 6, MAXIMUM DRAIN CURRENT vs CASE TEMPERATURE

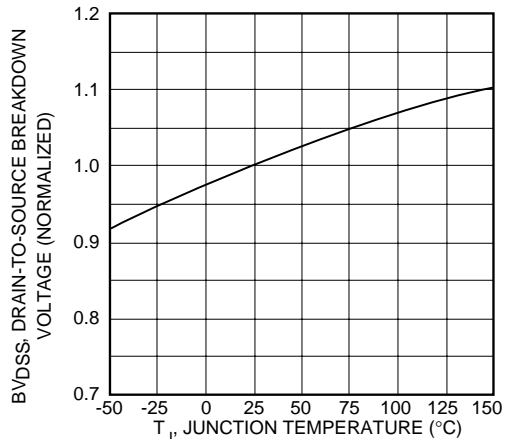

FIGURE 7, BREAKDOWN VOLTAGE vs TEMPERATURE

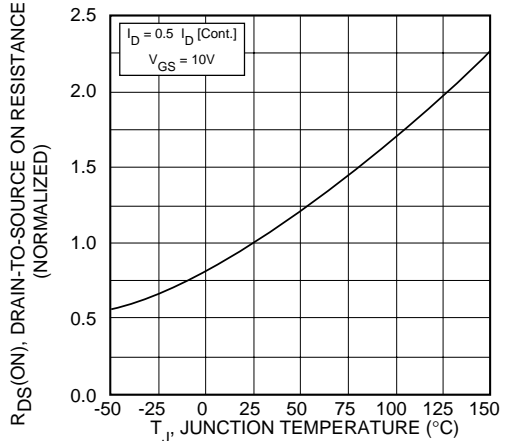

FIGURE 8, ON-RESISTANCE vs. TEMPERATURE

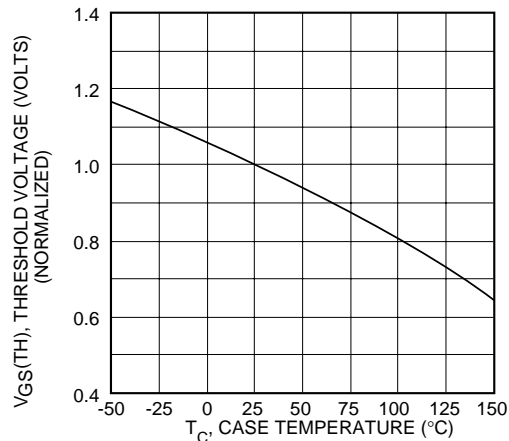

FIGURE 9, THRESHOLD VOLTAGE vs TEMPERATURE

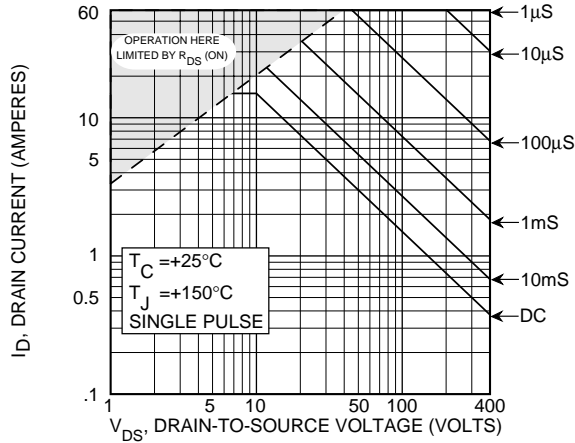

FIGURE 10, MAXIMUM SAFE OPERATING AREA

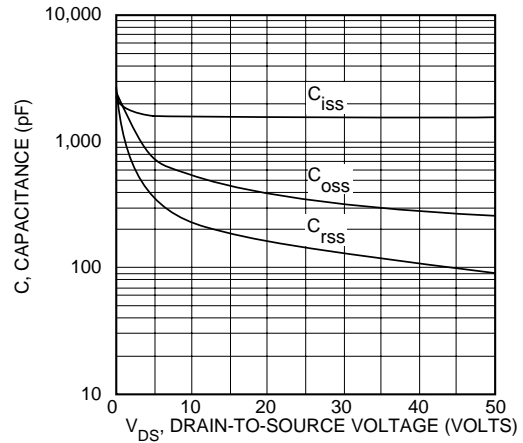

FIGURE 11, TYPICAL CAPACITANCE vs DRAIN-TO-SOURCE VOLTAGE

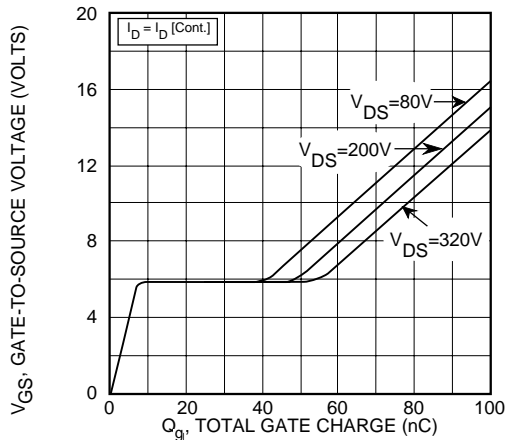

FIGURE 12, GATE CHARGES vs GATE-TO-SOURCE VOLTAGE

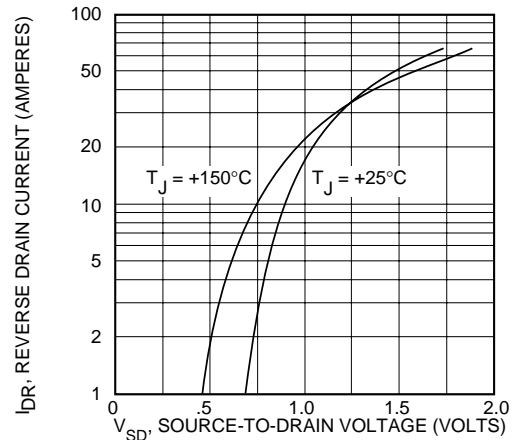
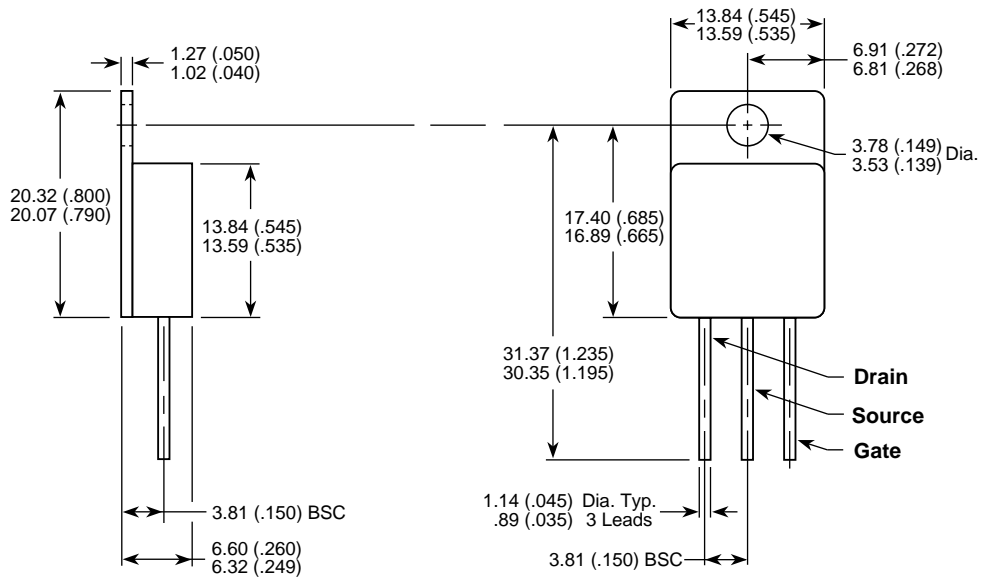

FIGURE 13, TYPICAL SOURCE-DRAIN DIODE FORWARD VOLTAGE

TO-254AA Package Outline



Dimensions in Millimeters and (Inches)