

POWER MOS V®

Power MOS V® is a new generation of high voltage N-Channel enhancement mode power MOSFETs. This new technology minimizes the JFET effect, increases packing density and reduces the on-resistance. Power MOS V® also achieves faster switching speeds through optimized gate layout.

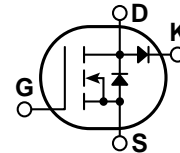

- **Faster Switching**
- **100% Avalanche Tested**
- **Lower Leakage**
- **Popular SOT-227 Package**
- **Single Die MOSFET & FRED**
- **PFC "Boost" Configuration**



MAXIMUM RATINGS

All Ratings: $T_C = 25^\circ\text{C}$ unless otherwise specified.

Symbol	Parameter	APT5010JVRU2	UNIT
V_{DSS}	Drain-Source Voltage	500	Volts
I_D	Continuous Drain Current @ $T_C = 25^\circ\text{C}$	44	Amps
I_{DM}	Pulsed Drain Current ^①	176	
V_{GS}	Gate-Source Voltage Continuous	± 30	Volts
V_{GSM}	Gate-Source Voltage Transient	± 40	
P_D	Total Power Dissipation @ $T_C = 25^\circ\text{C}$	450	Watts
	Linear Derating Factor	3.6	W/ $^\circ\text{C}$
T_J, T_{STG}	Operating and Storage Junction Temperature Range	-55 to 150	$^\circ\text{C}$
T_L	Lead Temperature: 0.063" from Case for 10 Sec.	300	
I_{AR}	Avalanche Current ^① (Repetitive and Non-Repetitive)	44	Amps
E_{AR}	Repetitive Avalanche Energy ^①	50	mJ
E_{AS}	Single Pulse Avalanche Energy ^④	2500	

STATIC ELECTRICAL CHARACTERISTICS

Symbol	Characteristic / Test Conditions	MIN	TYP	MAX	UNIT
BV_{DSS}	Drain-Source Breakdown Voltage ($V_{GS} = 0V, I_D = 250\mu\text{A}$)	500			Volts
$I_{D(on)}$	On State Drain Current ^② ($V_{DS} > I_{D(on)} \times R_{DS(on)}$ Max, $V_{GS} = 10V$)	44			Amps
$R_{DS(on)}$	Drain-Source On-State Resistance ^② ($V_{GS} = 10V, 0.5 I_{D[Cont.]}$)			0.100	Ohms
I_{DSS}	Zero Gate Voltage Drain Current ($V_{DS} = V_{DSS}, V_{GS} = 0V$)			25	μA
	Zero Gate Voltage Drain Current ($V_{DS} = 0.8 V_{DSS}, V_{GS} = 0V, T_C = 125^\circ\text{C}$)			250	
I_{GSS}	Gate-Source Leakage Current ($V_{GS} = \pm 30V, V_{DS} = 0V$)			± 100	nA
$V_{GS(th)}$	Gate Threshold Voltage ($V_{DS} = V_{GS}, I_D = 2.5\text{mA}$)	2		4	Volts

 **CAUTION:** These Devices are Sensitive to Electrostatic Discharge. Proper Handling Procedures Should Be Followed.

USA

405 S.W. Columbia Street

EUROPE

Avenue J.F. Kennedy Bât B4 Parc Cadéra Nord

APT Website - <http://www.advancedpower.com>

Bend, Oregon 97702-1035

Phone: (541) 382-8028

FAX: (541) 388-0364

F-33700 Merignac - France

Phone: (33) 5 57 92 15 15

FAX: (33) 5 56 47 97 61

DYNAMIC CHARACTERISTICS

APT5010JVRU2

Symbol	Characteristic	Test Conditions	MIN	TYP	MAX	UNIT
C_{iss}	Input Capacitance	$V_{GS} = 0V$ $V_{DS} = 25V$ $f = 1 \text{ MHz}$		7410		pF
C_{oss}	Output Capacitance			1050		
C_{rss}	Reverse Transfer Capacitance			390		
Q_g	Total Gate Charge ③	$V_{GS} = 10V$ $V_{DD} = 0.5 V_{DSS}$ $I_D = I_{D[Cont.]} @ 25^\circ C$		312		nC
Q_{gs}	Gate-Source Charge			37		
Q_{gd}	Gate-Drain ("Miller") Charge			127		
$t_{d(on)}$	Turn-on Delay Time	$V_{GS} = 15V$ $V_{DD} = 0.5 V_{DSS}$ $I_D = I_{D[Cont.]} @ 25^\circ C$ $R_G = 0.6\Omega$		18		ns
t_r	Rise Time			16		
$t_{d(off)}$	Turn-off Delay Time			54		
t_f	Fall Time			5		

SOURCE-DRAIN DIODE RATINGS AND CHARACTERISTICS

Symbol	Characteristic / Test Conditions	MIN	TYP	MAX	UNIT
I_S	Continuous Source Current (Body Diode)			44	Amps
I_{SM}	Pulsed Source Current ① (Body Diode)			176	
V_{SD}	Diode Forward Voltage ② ($V_{GS} = 0V, I_S = -I_{D[Cont.]}$)			1.3	Volts
t_{rr}	Reverse Recovery Time ($I_S = -I_{D[Cont.]}, di_S/dt = 100A/\mu s$)		620		ns
Q_{rr}	Reverse Recovery Charge ($I_S = -I_{D[Cont.]}, di_S/dt = 100A/\mu s$)		14.7		μC

THERMAL/PACKAGE CHARACTERISTICS

Symbol	Characteristic	MIN	TYP	MAX	UNIT
$R_{\theta JC}$	Junction to Case			0.28	$^\circ C/W$
$R_{\theta JA}$	Junction to Ambient			40	
$V_{isolation}$	RMS Voltage (50-60 Hz Sinusoidal Waveform From Terminals to Mounting Base for 1 Min.)	2500			Volts
Torque	Maximum Torque for Device Mounting Screws and Electrical Terminations.			13	lb•in

- ① Repetitive Rating: Pulse width limited by maximum junction temperature.
- ② Pulse Test: Pulse width < 380 μs , Duty Cycle < 2%
- ③ See MIL-STD-750 Method 3471
- ④ Starting $T_j = +25^\circ C$, $L = 2.58mH$, $R_G = 25\Omega$, Peak $I_L = 44A$

APT Reserves the right to change, without notice, the specifications and information contained herein.

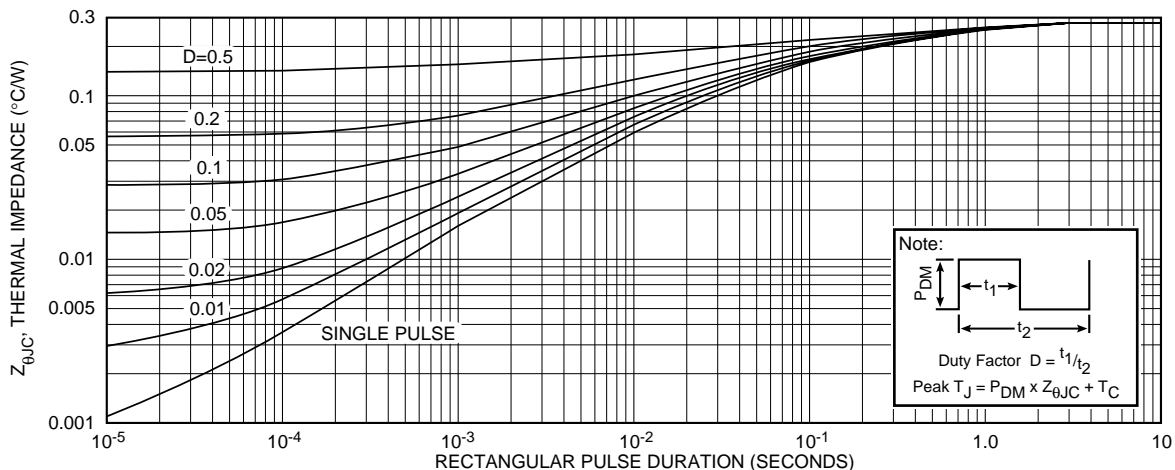

FIGURE 1, MAXIMUM EFFECTIVE TRANSIENT THERMAL IMPEDANCE, JUNCTION-TO-CASE vs PULSE DURATION

APT5010JVRU2

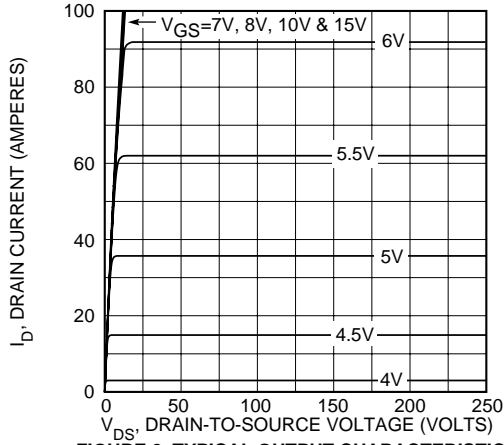

FIGURE 2, TYPICAL OUTPUT CHARACTERISTICS

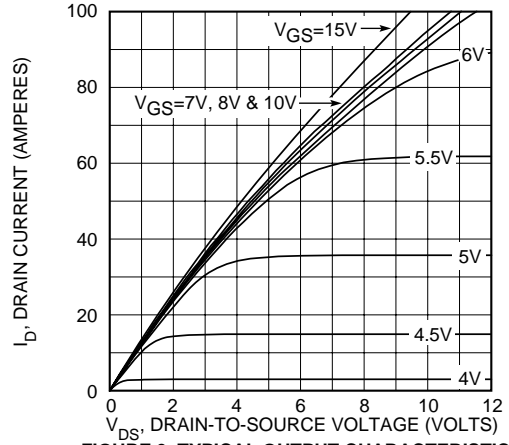

FIGURE 3, TYPICAL OUTPUT CHARACTERISTICS

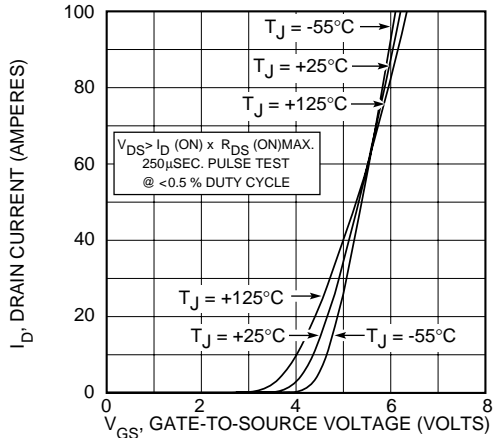

FIGURE 4, TYPICAL TRANSFER CHARACTERISTICS

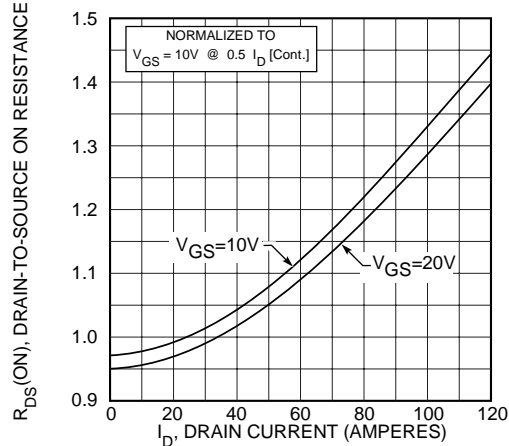

FIGURE 5, $R_{DS(ON)}$ vs DRAIN CURRENT

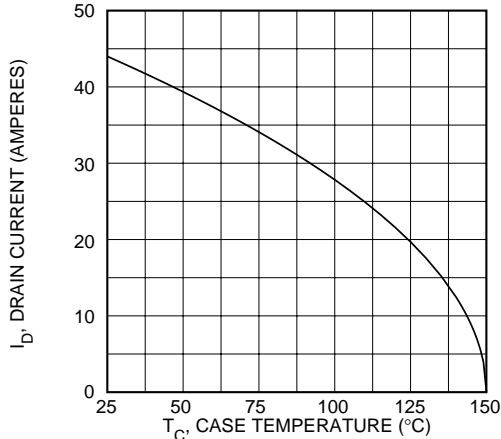

FIGURE 6, MAXIMUM DRAIN CURRENT vs CASE TEMPERATURE

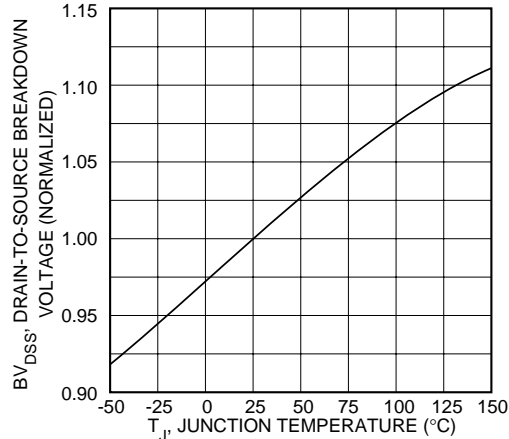

FIGURE 7, BREAKDOWN VOLTAGE vs TEMPERATURE

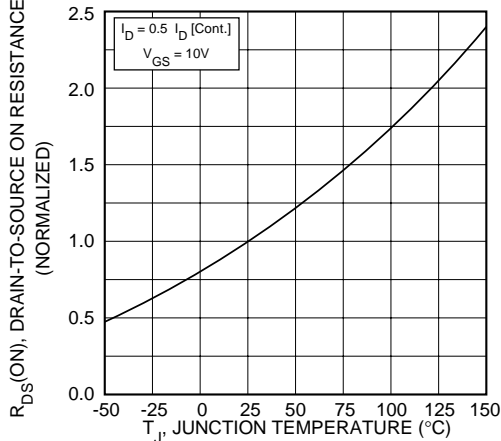

FIGURE 8, ON-RESISTANCE vs. TEMPERATURE

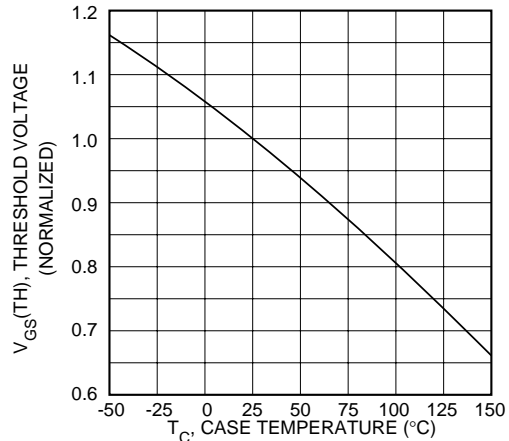

FIGURE 9, THRESHOLD VOLTAGE vs TEMPERATURE

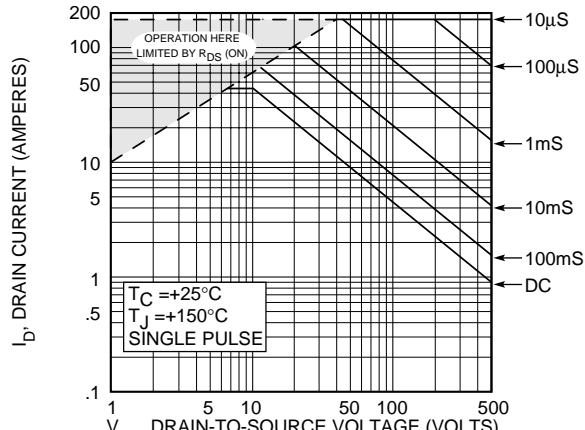

FIGURE 10, MAXIMUM SAFE OPERATING AREA

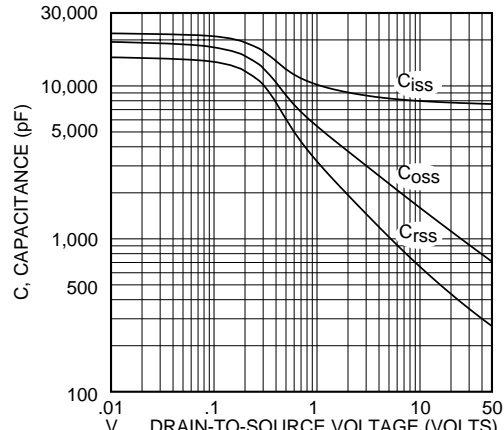

FIGURE 11, TYPICAL CAPACITANCE vs DRAIN-TO-SOURCE VOLTAGE

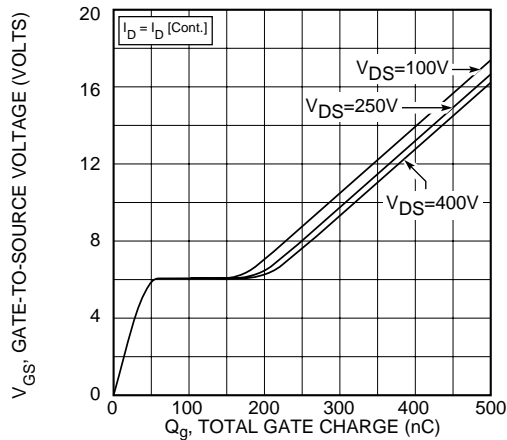

FIGURE 12, GATE CHARGES vs GATE-TO-SOURCE VOLTAGE

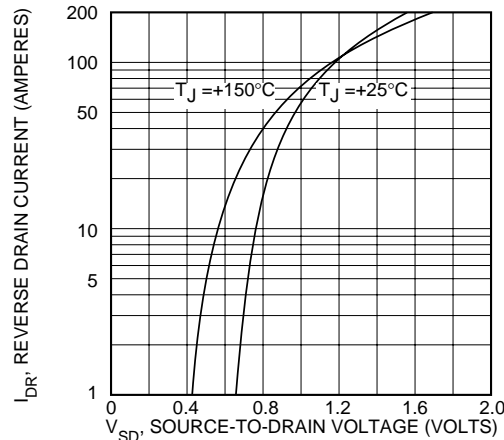

FIGURE 13, TYPICAL SOURCE-DRAIN DIODE FORWARD VOLTAGE

Diode Specifications Section

MAXIMUM RATINGS (UltraFast Recovery Diode)

All Ratings: $T_C = 25^\circ\text{C}$ unless otherwise specified.

Symbol	Characteristic / Test Conditions	APT5010JVRU2	UNIT
V_R	Maximum D.C. Reverse Voltage	600	Volts
V_{RRM}	Maximum Peak Repetitive Reverse Voltage		
V_{RWM}	Maximum Working Peak Reverse Voltage		
$I_F(AV)$	Maximum Average Forward Current ($T_C = 80^\circ\text{C}$, Duty Cycle = 0.5)	30	Amps
$I_F(RMS)$	RMS Forward Current	60	
I_{FSM}	Non-Repetitive Forward Surge Current ($T_J = 45^\circ\text{C}$, 8.3mS)	320	
T_J, T_{STG}	Operating and Storage Temperature Range	-55 to 150	$^\circ\text{C}$
T_L	Lead Temperature: 0.063" from Case for 10 Sec.	300	

STATIC ELECTRICAL CHARACTERISTICS

Symbol	Characteristic / Test Conditions	MIN	TYP	MAX	UNIT
V_F	Maximum Forward Voltage	$I_F = 30\text{A}$		1.8	Volts
		$I_F = 60\text{A}$		1.5	
		$I_F = 30\text{A}, T_J = 150^\circ\text{C}$		1.6	
I_{RM}	Maximum Reverse Leakage Current	$V_R = V_R$ Rated		250	μA
		$V_R = V_R$ Rated, $T_J = 125^\circ\text{C}$		500	
C_T	Junction Capacitance, $V_R = 200\text{V}$		40		pF

DYNAMIC CHARACTERISTICS

Symbol	Characteristic	MIN	TYP	MAX	UNIT
t_{rr1}	Reverse Recovery Time, $I_F = 1.0A$, $di_F/dt = -15A/\mu S$, $V_R = 30V$, $T_J = 25^\circ C$		50	65	nS
t_{rr2}	Reverse Recovery Time		50		
t_{rr3}	$I_F = 30A$, $di_F/dt = -240A/\mu S$, $V_R = 350V$		80		
t_{fr1}	Forward Recovery Time		155		Volts
t_{fr2}	$I_F = 30A$, $di_F/dt = 240A/\mu S$, $V_R = 350V$		155		
I_{RRM1}	Reverse Recovery Current		4	10	Amps
I_{RRM2}	$I_F = 30A$, $di_F/dt = -240A/\mu S$, $V_R = 350V$		7.5	15	
Q_{rr1}	Recovery Charge		100		nC
Q_{rr2}	$I_F = 30A$, $di_F/dt = -240A/\mu S$, $V_R = 350V$		300		
V_{fr1}	Forward Recovery Voltage		5		Volts
V_{fr2}	$I_F = 30A$, $di_F/dt = 240A/\mu S$, $V_R = 350V$		5		
diM/dt	Rate of Fall of Recovery Current		400		A/ μS
	$I_F = 30A$, $di_F/dt = -240A/\mu S$, $V_R = 350V$ (See Figure 10)		200		

THERMAL AND MECHANICAL CHARACTERISTICS

Symbol	Characteristic / Test Conditions	MIN	TYP	MAX	UNIT
$R_{\theta JC}$	Junction-to-Case Thermal Resistance			0.90	$^\circ C/W$
$R_{\theta JA}$	Junction-to-Ambient Thermal Resistance			20	
W_T	Package Weight		1.06		oz.
			30		gm.

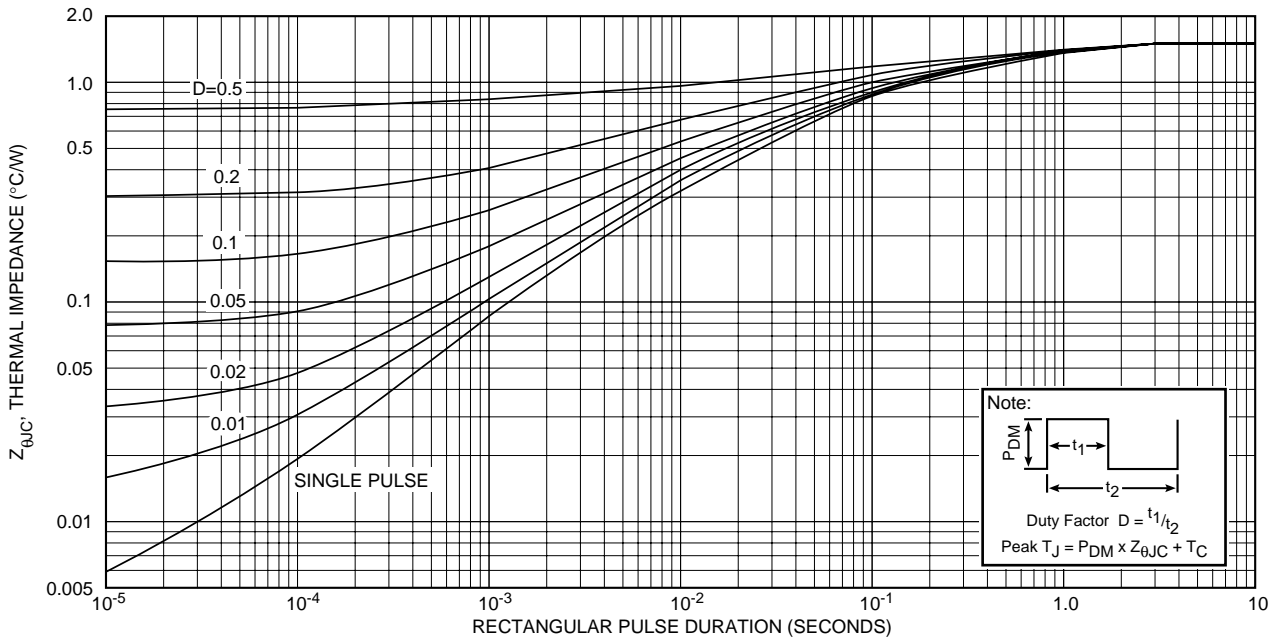

FIGURE 14, MAXIMUM EFFECTIVE TRANSIENT THERMAL IMPEDANCE, JUNCTION-TO-CASE vs PULSE DURATION

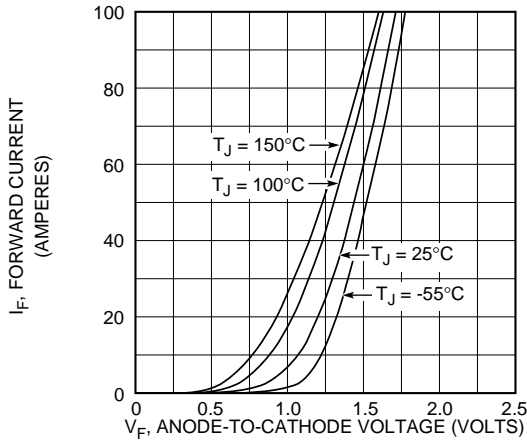

Figure 15, Forward Voltage Drop vs Forward Current

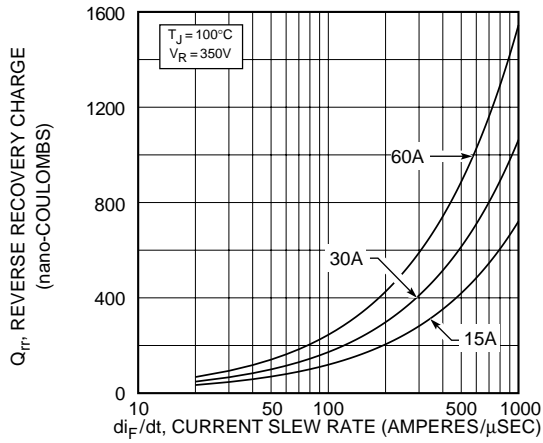

Figure 16, Reverse Recovery Charge vs Current Slew Rate

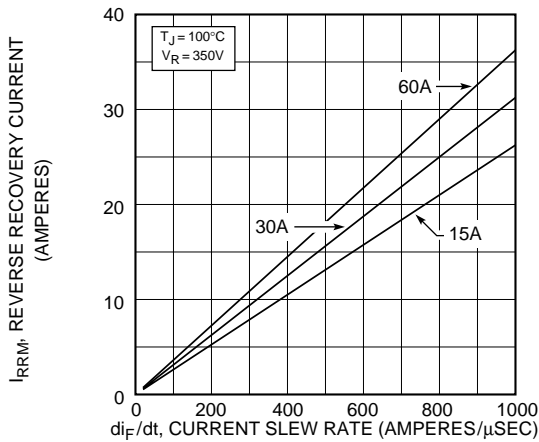

Figure 17, Reverse Recovery Current vs Current Slew Rate

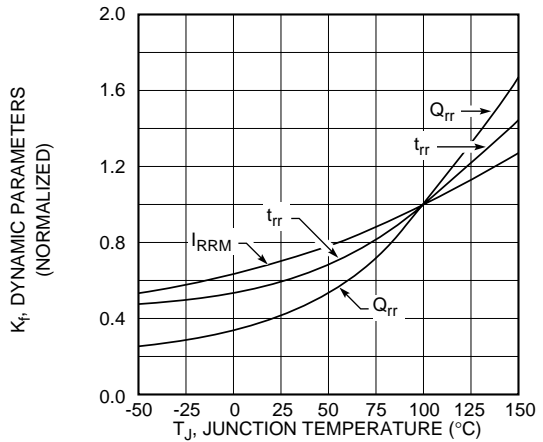

Figure 18, Dynamic Parameters vs Junction Temperature

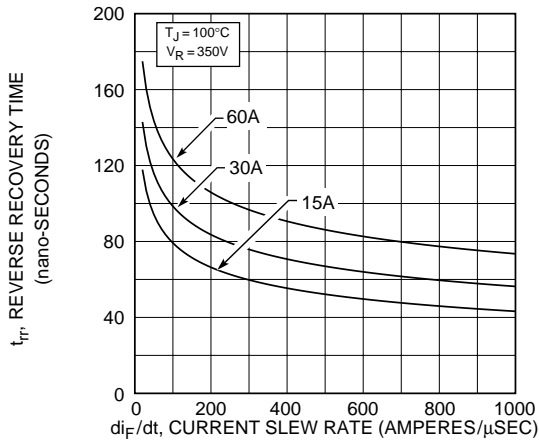

Figure 19, Reverse Recovery Time vs Current Slew Rate

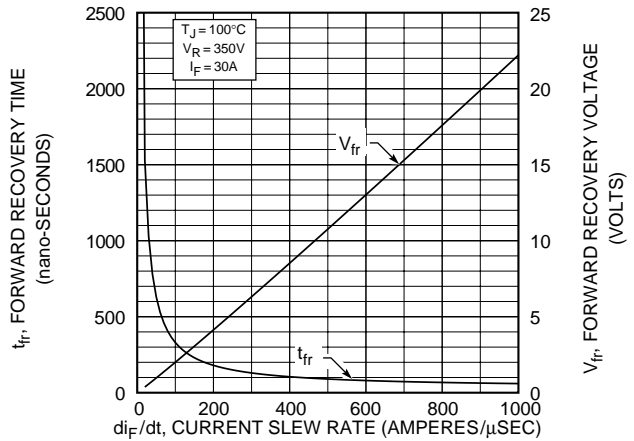

Figure 20, Forward Recovery Voltage/Time vs Current Slew Rate

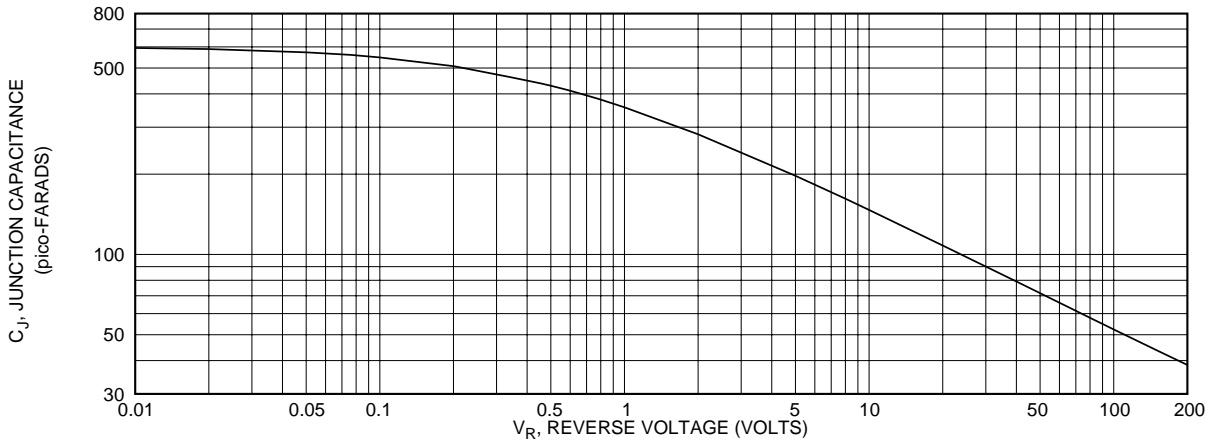

Figure 21, Junction Capacitance vs Reverse Voltage

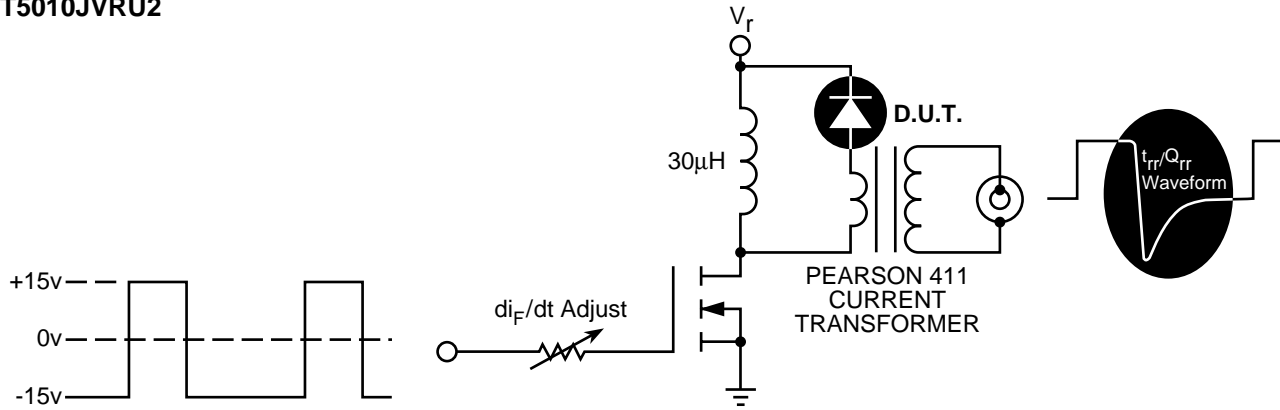
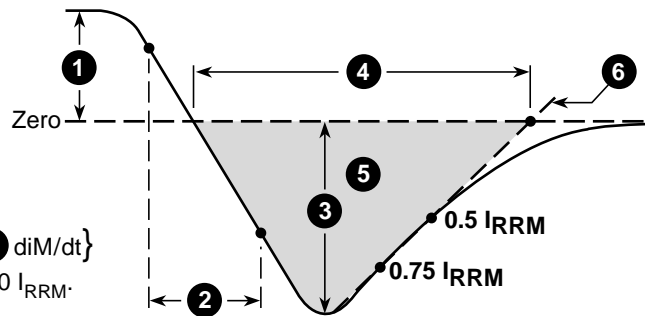

Figure 22, Diode Reverse Recovery Test Circuit and Waveforms

- 1 I_F - Forward Conduction Current
- 2 di_F/dt - Current Slew Rate, Rate of Forward Current Change Through Zero Crossing.
- 3 I_{RRM} - Peak Reverse Recovery Current.
- 4 t_{rr} - Reverse Recovery Time Measured from Point of I_F Current Falling Through Zero to a Tangent Line { 6 diM/dt } Extrapolated Through Zero Defined by 0.75 and 0.50 I_{RRM} .
- 5 Q_{rr} - Area Under the Curve Defined by I_{RRM} and t_{rr} .
- 6 diM/dt - Maximum Rate of Current Change During the Trailing Portion of t_{rr} .



$$Q_{rr} = 1/2 (t_{rr} \cdot I_{RRM})$$

Figure 23, Diode Reverse Recovery Waveform and Definitions

SOT-227 (ISOTOP®) Package Outline

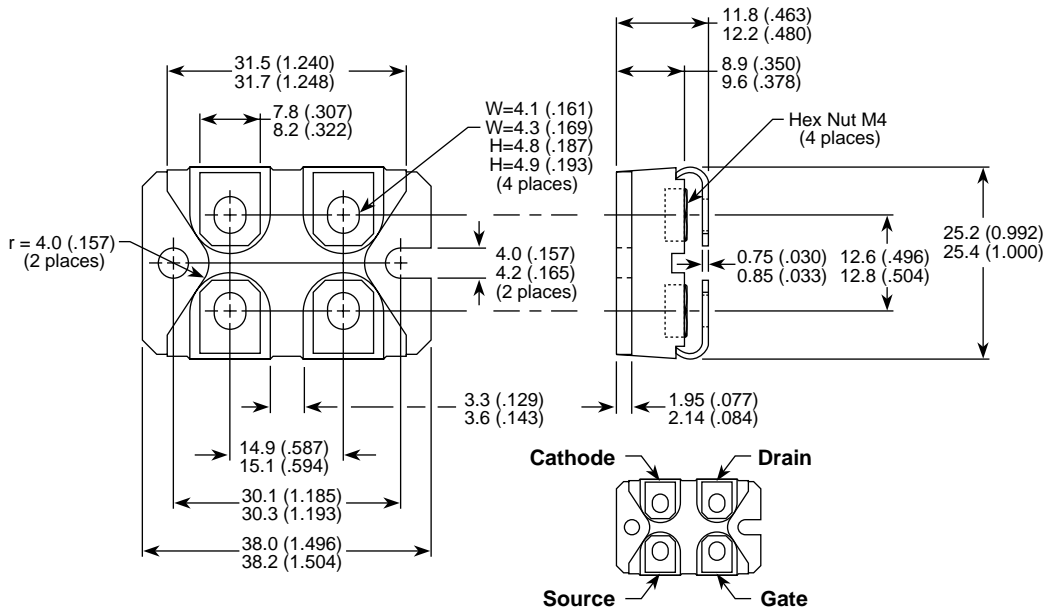

Dimensions in Millimeters and (Inches)