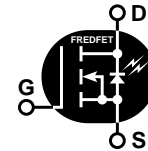
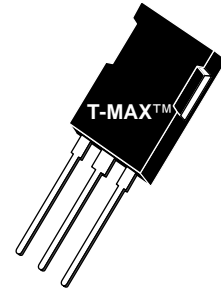


## POWER MOS V®

**FREDFET**

Power MOS V® is a new generation of high voltage N-Channel enhancement mode power MOSFETs. This new technology minimizes the JFET effect, increases packing density and reduces the on-resistance. Power MOS V® also achieves faster switching speeds through optimized gate layout.



- Fast Recovery Body Diode
- Lower Leakage
- Faster Switching
- 100% Avalanche Tested
- New T-MAX™ Package  
(Clip-mounted TO-247 Package)

### MAXIMUM RATINGS

 All Ratings:  $T_C = 25^\circ\text{C}$  unless otherwise specified.

Symbol	Parameter	APT8030B2VFR	UNIT
$V_{DSS}$	Drain-Source Voltage	800	Volts
$I_D$	Continuous Drain Current @ $T_C = 25^\circ\text{C}$	27	Amps
$I_{DM}$	Pulsed Drain Current <sup>①</sup>	108	
$V_{GS}$	Gate-Source Voltage Continuous	$\pm 30$	Volts
$V_{GSM}$	Gate-Source Voltage Transient	$\pm 40$	
$P_D$	Total Power Dissipation @ $T_C = 25^\circ\text{C}$	520	Watts
	Linear Derating Factor	4.16	W/°C
$T_J, T_{STG}$	Operating and Storage Junction Temperature Range	-55 to 150	°C
$T_L$	Lead Temperature: 0.063" from Case for 10 Sec.	300	
$I_{AR}$	Avalanche Current <sup>①</sup> (Repetitive and Non-Repetitive)	27	Amps
$E_{AR}$	Repetitive Avalanche Energy <sup>①</sup>	50	mJ
$E_{AS}$	Single Pulse Avalanche Energy <sup>④</sup>	2500	

### STATIC ELECTRICAL CHARACTERISTICS

Symbol	Characteristic / Test Conditions	MIN	TYP	MAX	UNIT
$BV_{DSS}$	Drain-Source Breakdown Voltage ( $V_{GS} = 0V, I_D = 250\mu\text{A}$ )	800			Volts
$I_{D(on)}$	On State Drain Current <sup>②</sup> ( $V_{DS} > I_{D(on)} \times R_{DS(on)}$ Max, $V_{GS} = 10V$ )	27			Amps
$R_{DS(on)}$	Drain-Source On-State Resistance <sup>②</sup> ( $V_{GS} = 10V, 0.5 I_{D[Cont.]}$ )			0.300	Ohms
$I_{DSS}$	Zero Gate Voltage Drain Current ( $V_{DS} = V_{DSS}, V_{GS} = 0V$ )			250	$\mu\text{A}$
	Zero Gate Voltage Drain Current ( $V_{DS} = 0.8 V_{DSS}, V_{GS} = 0V, T_C = 125^\circ\text{C}$ )			1000	
$I_{GSS}$	Gate-Source Leakage Current ( $V_{GS} = \pm 30V, V_{DS} = 0V$ )			$\pm 100$	nA
$V_{GS(th)}$	Gate Threshold Voltage ( $V_{DS} = V_{GS}, I_D = 2.5\text{mA}$ )	2		4	Volts

 **CAUTION:** These Devices are Sensitive to Electrostatic Discharge. Proper Handling Procedures Should Be Followed.

**USA**

405 S.W. Columbia Street

**EUROPE**

Avenue J.F. Kennedy Bât B4 Parc Cadéra Nord

**APT Website - <http://www.advancedpower.com>**

Bend, Oregon 97702-1035

Phone: (541) 382-8028

FAX: (541) 388-0364

F-33700 Merignac - France

Phone: (33) 5 57 92 15 15

FAX: (33) 5 56 47 97 61

**DYNAMIC CHARACTERISTICS**

**APT8030B2VFR**

Symbol	Characteristic	Test Conditions	MIN	TYP	MAX	UNIT
C <sub>iss</sub>	Input Capacitance	V <sub>GS</sub> = 0V		6600	7900	pF
C <sub>oss</sub>	Output Capacitance	V <sub>DS</sub> = 25V		645	900	
C <sub>rss</sub>	Reverse Transfer Capacitance	f = 1 MHz		320	480	
Q <sub>g</sub>	Total Gate Charge ③	V <sub>GS</sub> = 10V		340	510	nC
Q <sub>gs</sub>	Gate-Source Charge	V <sub>DD</sub> = 0.5 V <sub>DSS</sub>		31	47	
Q <sub>gd</sub>	Gate-Drain ("Miller") Charge	I <sub>D</sub> = I <sub>D</sub> [Cont.] @ 25°C		170	250	
t <sub>d(on)</sub>	Turn-on Delay Time	V <sub>GS</sub> = 15V		16	32	ns
t <sub>r</sub>	Rise Time	V <sub>DD</sub> = 0.5 V <sub>DSS</sub>		14	28	
t <sub>d(off)</sub>	Turn-off Delay Time	I <sub>D</sub> = I <sub>D</sub> [Cont.] @ 25°C		59	90	
t <sub>f</sub>	Fall Time	R <sub>G</sub> = 0.6Ω		8	16	

**SOURCE-DRAIN DIODE RATINGS AND CHARACTERISTICS**

Symbol	Characteristic / Test Conditions	MIN	TYP	MAX	UNIT
I <sub>S</sub>	Continuous Source Current (Body Diode)			27	Amps
I <sub>SM</sub>	Pulsed Source Current ① (Body Diode)			108	
V <sub>SD</sub>	Diode Forward Voltage ② (V <sub>GS</sub> = 0V, I <sub>S</sub> = -I <sub>D</sub> [Cont.])			1.3	Volts
dv/dt	Peak Diode Recovery dv/dt ⑥			5	V/ns
t <sub>rr</sub>	Reverse Recovery Time (I <sub>S</sub> = -I <sub>D</sub> [Cont.], di/dt = 100A/μs)	T <sub>j</sub> = 25°C		300	ns
		T <sub>j</sub> = 125°C		600	
Q <sub>rr</sub>	Reverse Recovery Charge (I <sub>S</sub> = -I <sub>D</sub> [Cont.], di/dt = 100A/μs)	T <sub>j</sub> = 25°C		2.0	μC
		T <sub>j</sub> = 125°C		6.7	
I <sub>RRM</sub>	Peak Recovery Current (I <sub>S</sub> = -I <sub>D</sub> [Cont.], di/dt = 100A/μs)	T <sub>j</sub> = 25°C		13	Amps
		T <sub>j</sub> = 125°C		22	

**THERMAL CHARACTERISTICS**

Symbol	Characteristic	MIN	TYP	MAX	UNIT
R <sub>θJC</sub>	Junction to Case			0.24	°C/W
R <sub>θJA</sub>	Junction to Ambient			40	

- ① Repetitive Rating: Pulse width limited by maximum junction temperature.
- ② Pulse Test: Pulse width < 380 μs, Duty Cycle < 2%
- ③ See MIL-STD-750 Method 3471
- ④ Starting T<sub>j</sub> = +25°C, L = 6.86mH, R<sub>G</sub> = 25Ω, Peak I<sub>L</sub> = 27A
- ⑤ These dimensions are equal to the TO-247 without mounting hole
- ⑥ I<sub>S</sub> ≤ -I<sub>D</sub> [Cont.], di/dt = 100A/μs, V<sub>DD</sub> ≤ V<sub>DSS</sub>, T<sub>j</sub> ≤ 150°C, R<sub>G</sub> = 2.0Ω, V<sub>R</sub> = 200V.

APT Reserves the right to change, without notice, the specifications and information contained herein.

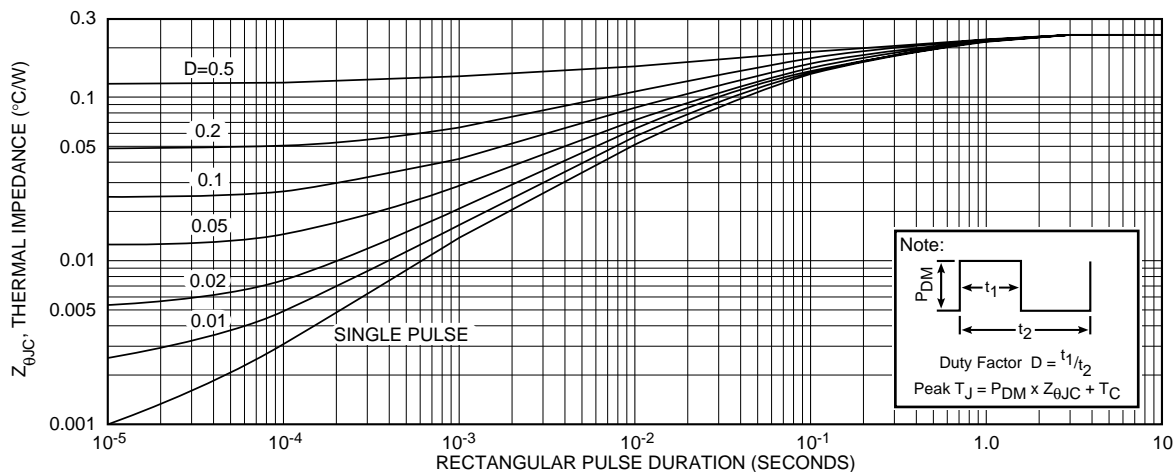
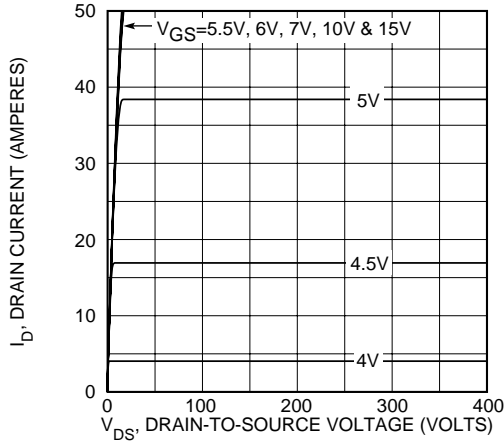
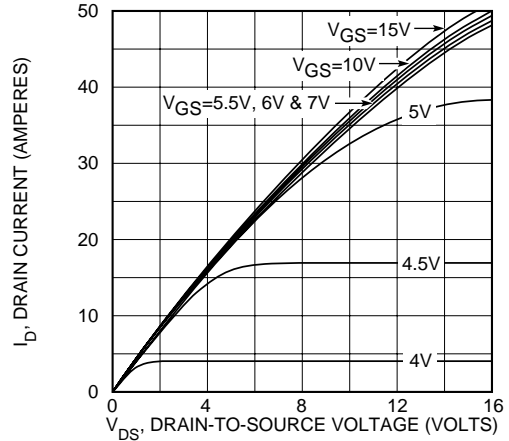


FIGURE 1, MAXIMUM EFFECTIVE TRANSIENT THERMAL IMPEDANCE, JUNCTION-TO-CASE vs PULSE DURATION

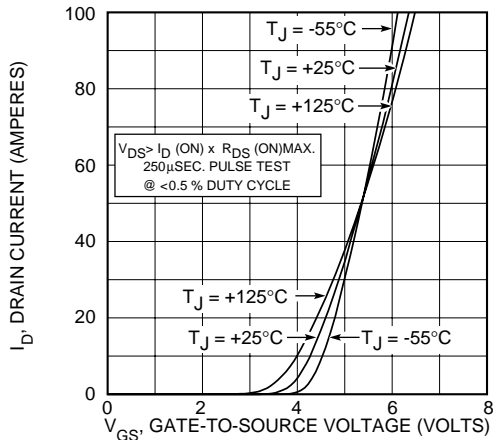
**APT8030B2VFR**



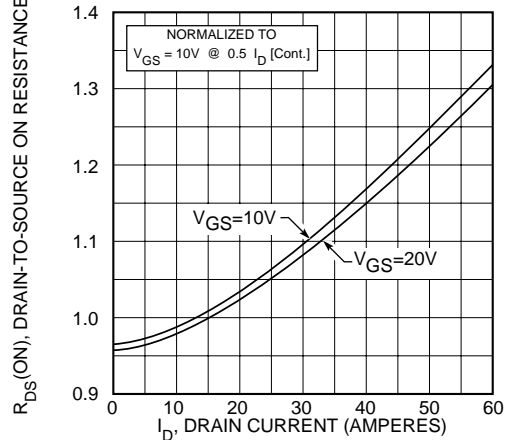
**FIGURE 2, TYPICAL OUTPUT CHARACTERISTICS**



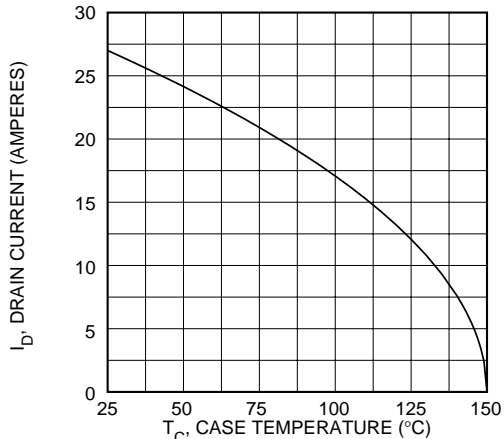
**FIGURE 3, TYPICAL OUTPUT CHARACTERISTICS**



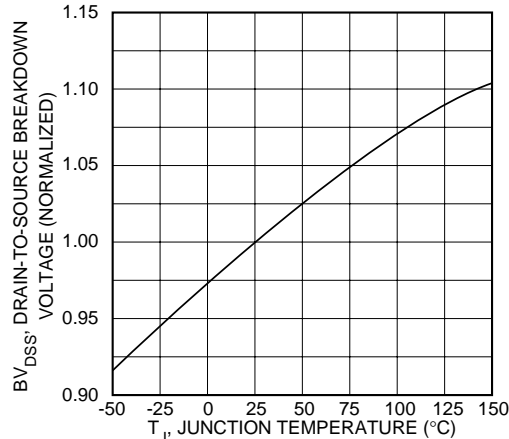
**FIGURE 4, TYPICAL TRANSFER CHARACTERISTICS**



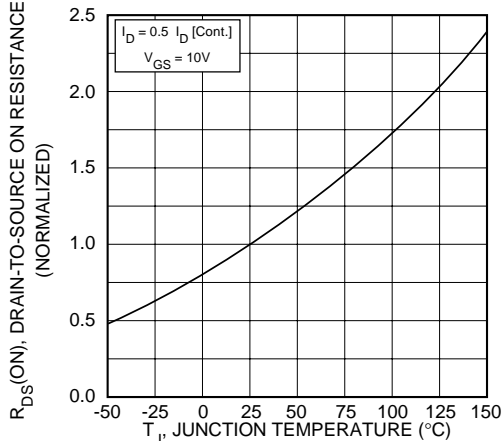
**FIGURE 5,  $R_{DS(ON)}$  vs DRAIN CURRENT**



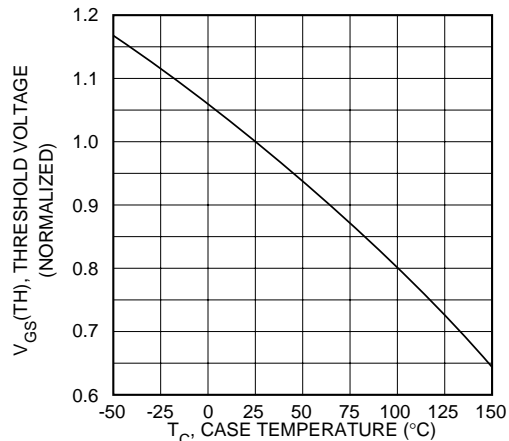
**FIGURE 6, MAXIMUM DRAIN CURRENT vs CASE TEMPERATURE**



**FIGURE 7, BREAKDOWN VOLTAGE vs TEMPERATURE**

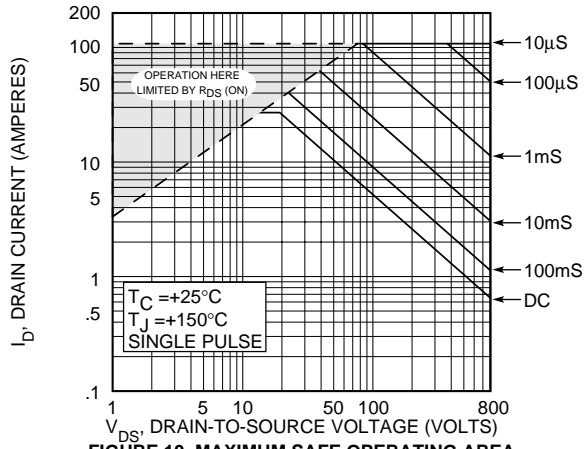


**FIGURE 8, ON-RESISTANCE vs. TEMPERATURE**

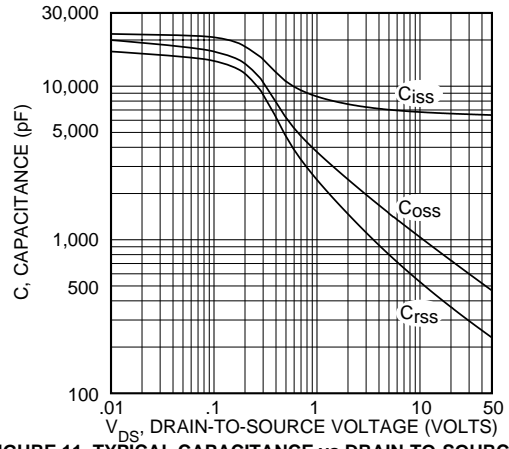


**FIGURE 9, THRESHOLD VOLTAGE vs TEMPERATURE**

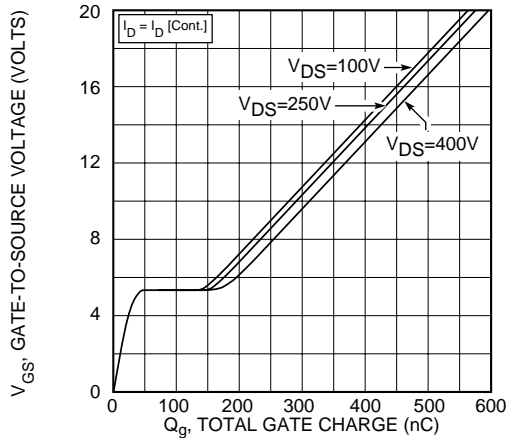
**APT8030B2VFR**



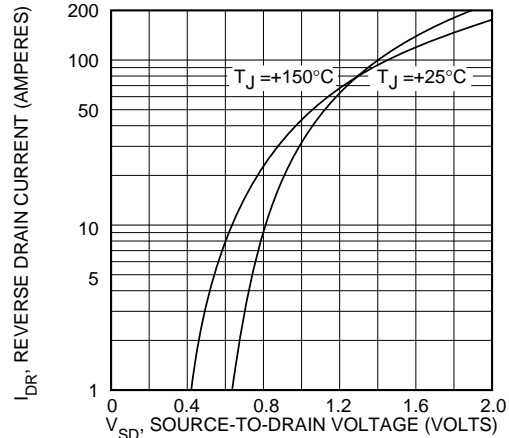
**FIGURE 10, MAXIMUM SAFE OPERATING AREA**



**FIGURE 11, TYPICAL CAPACITANCE vs DRAIN-TO-SOURCE VOLTAGE**

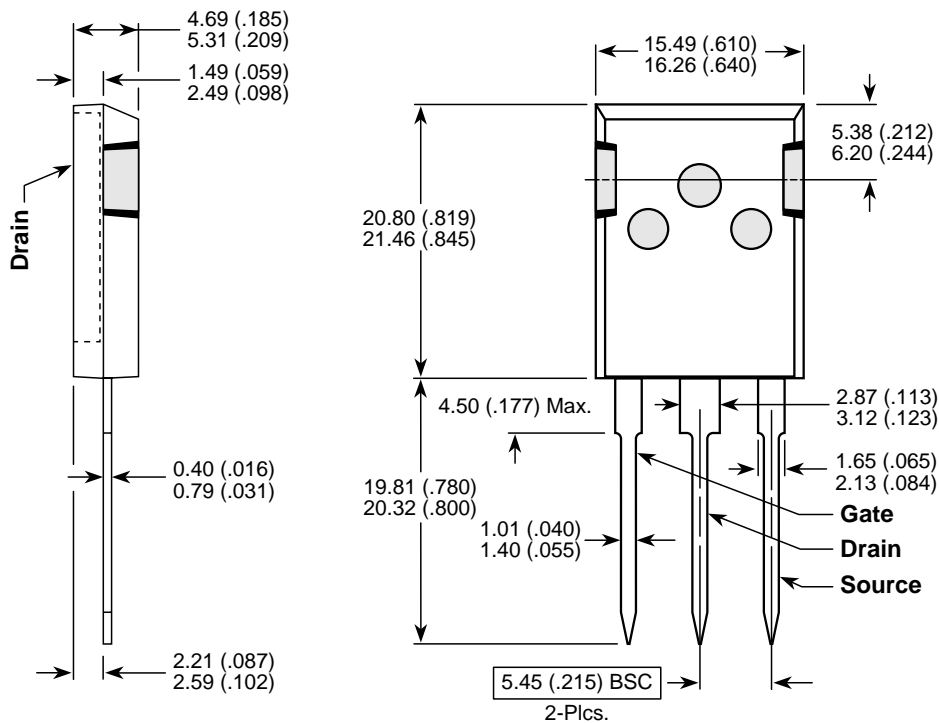


**FIGURE 12, GATE CHARGES vs GATE-TO-SOURCE VOLTAGE**



**FIGURE 13, TYPICAL SOURCE-DRAIN DIODE FORWARD VOLTAGE**

**T-MAX™ Package Outline ⑤**



Dimensions in Millimeters and (Inches)