

300mA Low Dropout Linear Regulator

FEATURES

- Low Dropout Voltage of 130mV at 100mA Output Current (5.2V Output Version).
- Guaranteed 300mA Output Current.
- Internal 1.3Ω P-MOSFET Draws no Base Current.
- Low Ground Current at 55μA.
- 2% Accuracy Output Voltage of 3.3V/ 3.5V/ 3.7V/ 3.8V/ 5.0V/ 5.2V.
- Input Voltage Range up to 12V.
- Needs only 1μF for Stability.
- Current and Thermal Limiting.

APPLICATIONS

- Voltage Regulator for CD-ROM Drivers.
- Voltage Regulator for LAN Cards.
- Voltage Regulator for Microprocessor.
- Wireless Communication Systems.
- Battery Powered Systems.

DESCRIPTION

The AIC1722 is a 3-pin low dropout linear regulator. The superior characteristics of the AIC1722 include zero base current loss, very low dropout voltage, and 2% accuracy output voltage. Typical ground current remains approximately 55μA, from no load to maximum loading conditions. Dropout voltage at 100mA output current is exceptionally low: 130mV for the AIC1722-50 and AIC1722-52, 180mV for the AIC1722-33, AIC1722-35, and AIC1722-37 AIC1722-38. Output current limiting and thermal limiting are built in to provide maximal protection to the AIC1722 against fault conditions.

The AIC1722 comes in the popular 3-pin SOT-89 and TO-92 packages.

TYPICAL APPLICATION CIRCUIT

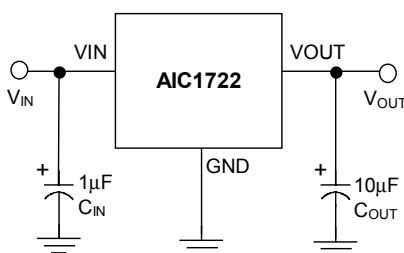

Low Dropout Linear Regulator

ORDERING INFORMATION

AIC1722-XXXXX

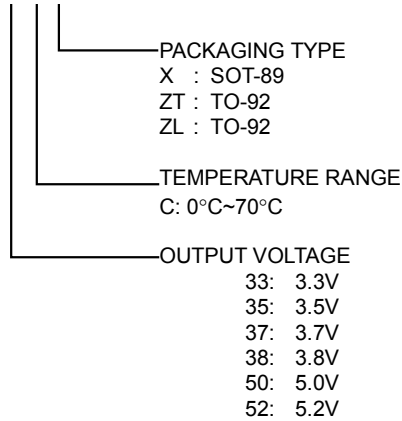

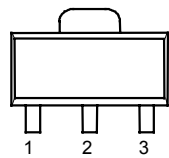
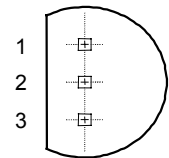
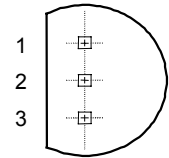
ORDER NUMBER	PIN CONFIGURATION
AIC1722-33CX AIC1722-35CX AIC1722-37CX AIC1722-38CX AIC1722-50CX AIC1722-52CX (SOT-89)	FRONT VIEW 1: VOUT 2: GND 3: VIN 
AIC1722-33CZT AIC1722-35CZT AIC1722-37CZT AIC1722-38CZT AIC1722-50CZT AIC1722-52CZT (TO-92 T TYPE)	TOP VIEW 1: GND 2: VIN 3: VOUT 
AIC1722-33CZL AIC1722-35CZL AIC1722-37CZL AIC1722-38CZL AIC1722-50CZL AIC1722-52CZL (TO-92 L TYPE)	TOP VIEW 1: VIN 2: GND 3: VOUT 

ABSOLUTE MAXIMUM RATINGS

Input Supply Voltage	-0.3~12V
Operating Junction Temperature Range	-40°C~ 125°C
Storage Temperature Range	-65°C~150°C
Power Dissipation	SOT-89 Package 0.5W
	TO-92 Package 0.5W

TEST CIRCUIT

Refer to the TYPICAL APPLICATION CIRCUIT

ELECTRICAL CHARACTERISTICS (Ta=25°C, C_{IN}=1μF, C_{OUT}=10μF, unless otherwise specified.)

PARAMETER	TEST CONDITIONS		MIN.	TYP.	MAX.	UNIT
Output Voltage	No Load					V
	AIC1722-52	V _{IN} =5.5~12V	5.100	5.2	5.300	
	AIC1722-50	V _{IN} =5.5~12V	4.900	5.0	5.100	
	AIC1722-38	V _{IN} =4.1~12V	3.725	3.8	3.875	
	AIC1722-37	V _{IN} =4.0~12V	3.625	3.7	3.775	
	AIC1722-35	V _{IN} =4.0~12V	3.430	3.5	3.570	
	AIC1722-33	V _{IN} =3.6~12V	3.235	3.3	3.365	

ELECTRICAL CHARACTERISTICS (Continued)

PARAMETER	TEST CONDITIONS		MIN.	TYP.	MAX.	UNIT
Output Voltage Temperature Coefficient	(Note 1)			50	150	PPM/°C
Line Regulation	$I_L=1\text{mA}$					
	AIC1722-52	$V_{IN}=5.5\sim 12\text{V}$		3	10	mV
	AIC1722-50	$V_{IN}=5.5\sim 12\text{V}$		3	10	
	AIC1722-38	$V_{IN}=4.1\sim 12\text{V}$		3	10	
	AIC1722-37	$V_{IN}=4.0\sim 12\text{V}$		3	10	
	AIC1722-35	$V_{IN}=4.0\sim 12\text{V}$		3	10	
AIC1722-33	$V_{IN}=3.6\sim 12\text{V}$		3	10		
Load Regulation (Note 2)	AIC1722-52	$V_{IN}=7\text{V}, I_L=0.1\sim 300\text{mA}$		7	25	mV
	AIC1722-50	$V_{IN}=7\text{V}, I_L=0.1\sim 300\text{mA}$		7	25	
	AIC1722-38	$V_{IN}=5\text{V}, I_L=0.1\sim 300\text{mA}$		7	25	
	AIC1722-37	$V_{IN}=5\text{V}, I_L=0.1\sim 300\text{mA}$		7	25	
	AIC1722-35	$V_{IN}=5\text{V}, I_L=0.1\sim 300\text{mA}$		7	25	
	AIC1722-33	$V_{IN}=5\text{V}, I_L=0.1\sim 300\text{mA}$		7	25	
Current Limit (Note 3)	AIC1722-52	$V_{IN}=7\text{V}, V_{OUT}=0\text{V}$	320	440		mA
	AIC1722-50	$V_{IN}=7\text{V}, V_{OUT}=0\text{V}$	320	440		
	AIC1722-38	$V_{IN}=7\text{V}, V_{OUT}=0\text{V}$	320	440		
	AIC1722-37	$V_{IN}=5\text{V}, V_{OUT}=0\text{V}$	320	440		
	AIC1722-35	$V_{IN}=5\text{V}, V_{OUT}=0\text{V}$	320	440		
	AIC1722-33	$V_{IN}=5\text{V}, V_{OUT}=0\text{V}$	320	440		
Dropout Voltage (Note 4)	AIC1722s	$I_L=0.1\text{mA}$		0.2	10	mV
	AIC1722-52	$I_L=300\text{mA}$		400	500	
	AIC1722-50	$I_L=300\text{mA}$		400	500	
	AIC1722-38	$I_L=300\text{mA}$		540	640	
	AIC1722-37	$I_L=300\text{mA}$		540	640	
	AIC1722-35	$I_L=300\text{mA}$		540	640	
	AIC1722-33	$I_L=300\text{mA}$		540	640	
Ground Current	$I_O=0.1\text{mA}\sim I_{MAX}$					μA
	AIC1722-52	$V_{IN}=5.5\sim 12\text{V}$		55	80	
	AIC1722-50	$V_{IN}=5.5\sim 12\text{V}$		55	80	
	AIC1722-38	$V_{IN}=4\sim 12\text{V}$		55	80	
	AIC1722-37	$V_{IN}=4\sim 12\text{V}$		55	80	
	AIC1722-33	$V_{IN}=4\sim 12\text{V}$		55	80	

Note 1: Guaranteed by design.

Note 2: Regulation is measured at constant junction temperature, using pulse testing with a low ON time.

Note 3: Current limit is measured by pulsing a short time.

Note 4: Dropout voltage is defined as the input to output differential at which the output voltage drops 100mV below the value measured with a 1V differential.

TYPICAL PERFORMANCE CHARACTERISTICS

Output Voltage vs. Temperature

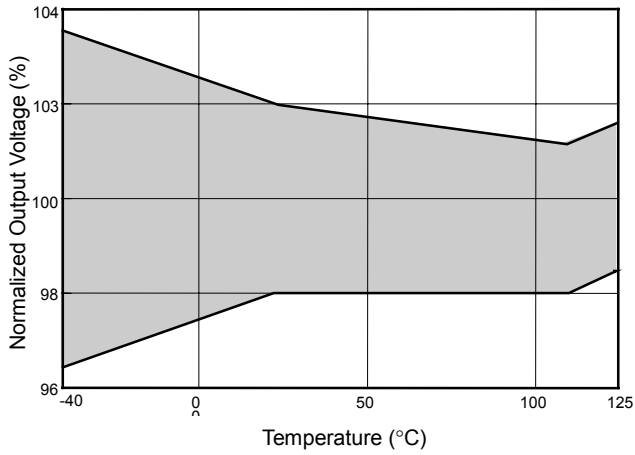

Ground Current vs. Input Voltage

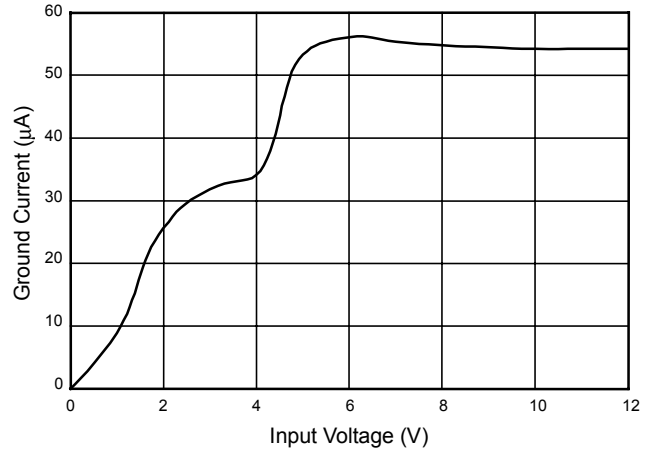

Ground Current vs. Temperature

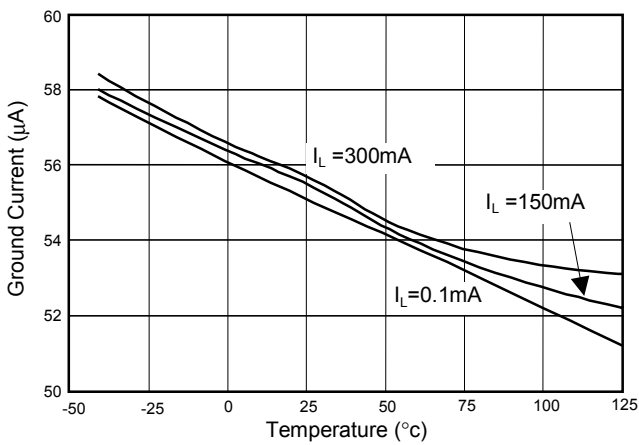

Dropout Voltage vs. Load Current

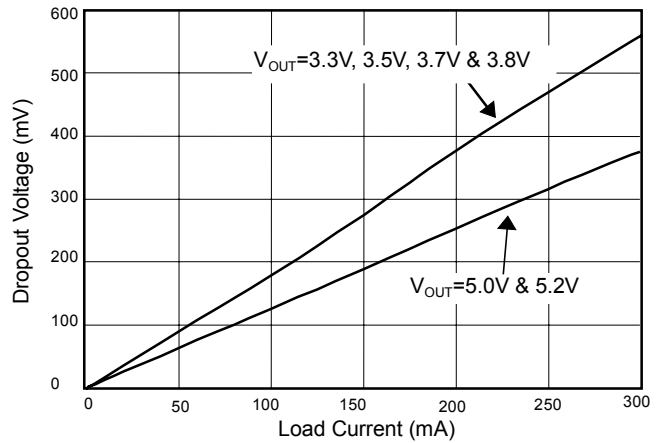

Line Transient Response

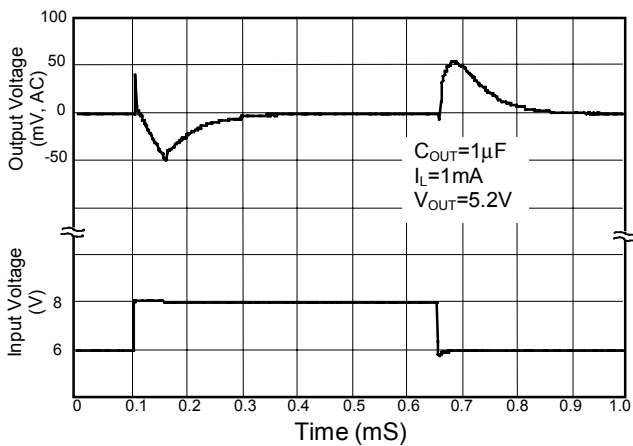

Load transient Response

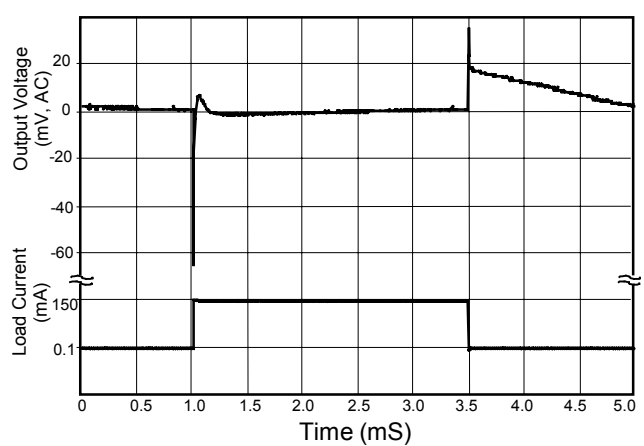

TYPICAL PERFORMANCE CHARACTERISTICS (Continued)

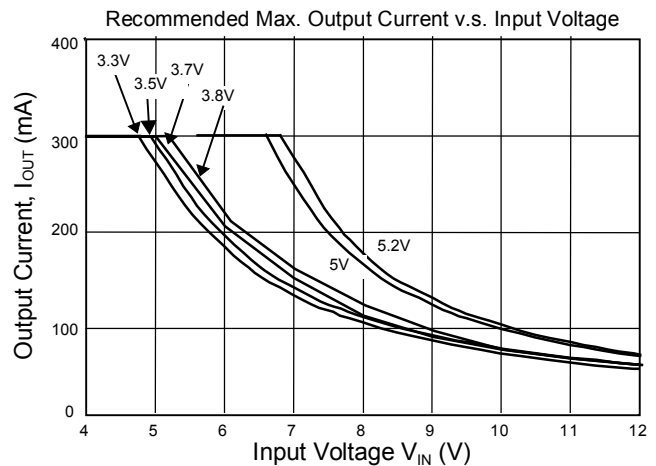
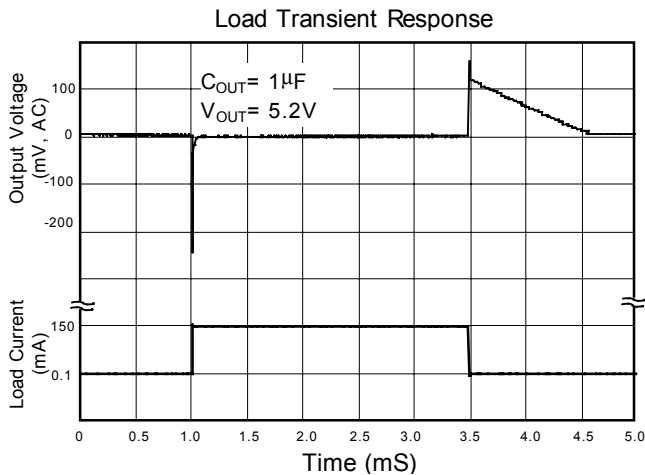

BLOCK DIAGRAM

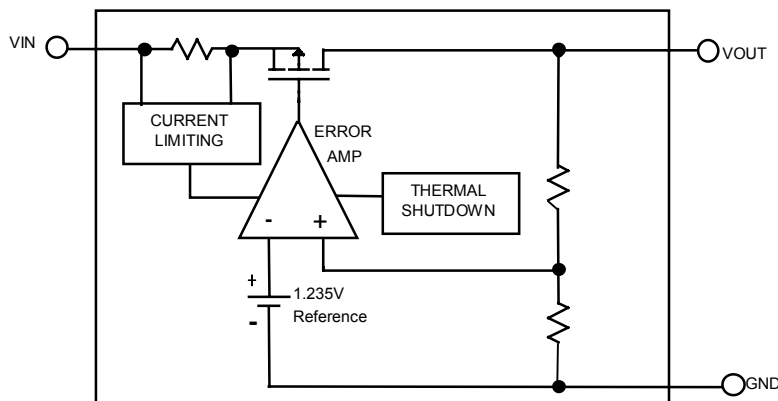

PIN DESCRIPTION

- VOUT PIN - Output pin.
- GND PIN - Power GND.
- VIN PIN - Power Supply Input.

APPLICATION INFORMATIONS

A 1µF (or greater) capacitor is required between the AIC1722 output and ground for stability. Without this capacitor the part will oscillate. Even though most types of capacitor may work, the equivalent series resistance (ESR) should be held to 5Ω or less if Aluminum electrolytic type is used. Many Aluminum electrolytics have electrolytes that freeze at about -30°C, so solid tantalums are recommended for operation below -25°C. The

value of this capacitor may be increased without limit.

A 0.1µF capacitor (or greater) should be placed from the AIC1722 input to ground if the lead inductance between the input and power source exceeds 500nH (approximately 10 inches of trace).

■ PHYSICAL DIMENSIONS

● SOT-89 (unit: mm)

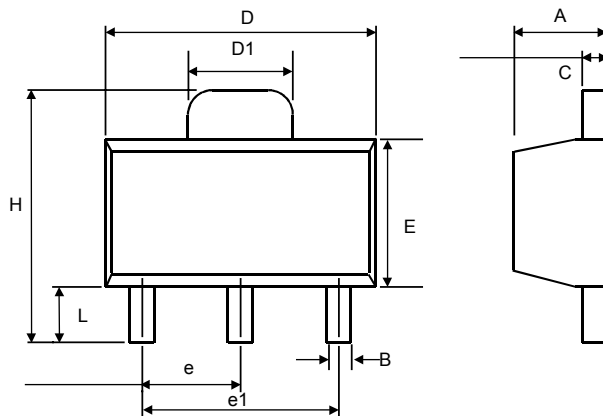

SYMBOL	MIN	MAX
A	1.40	1.60
B	0.36	0.48
C	0.35	0.44
D	4.40	4.60
D1	1.62	1.83
E	2.29	2.60
e	1.50 (TYP.)	
e1	3.00 (TYP.)	
H	3.94	4.25
L	0.89	1.20

SOT-89 MARKING

Part No.	Marking
AIC1722-33	AH33
AIC1722-35	AH35
AIC1722-37	AH37
AIC1722-38	AH38
AIC1722-50	AH50
AIC1722-52	AH52

● TO-92 (unit: mm)

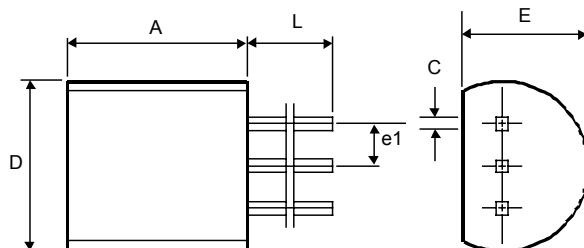

SYMBOL	MIN	MAX
A	4.32	5.33
C	0.38 (TYP.)	
D	4.40	5.20
E	3.17	4.20
e1	1.27 (TYP.)	
L	12.7	-