



# AKD5354

## Evaluation board Rev.A for AK5354

GENERAL DESCRIPTION

AKD5354 is an evaluation board for the portable digital audio 20bit A/D converter, AK5354. The AKD5354 includes the input circuit and also has a digital interface transmitter. Further, the AKD5354 can evaluate direct interface with AKM's D/A converter evaluation board.

■ **Ordering guide**

AKD5354 --- Evaluation board for AK5354  
 (Cable for connecting with printer port of IBM-AT, compatible PC and control software are packed with this.)

FUNCTION

- **Compatible with 2 types of interface**
  - Direct interface with AKM's D/A converter evaluation boards
  - On-board AK4353 as DIT which transmits optical output
- **BNC connector for an external clock input**

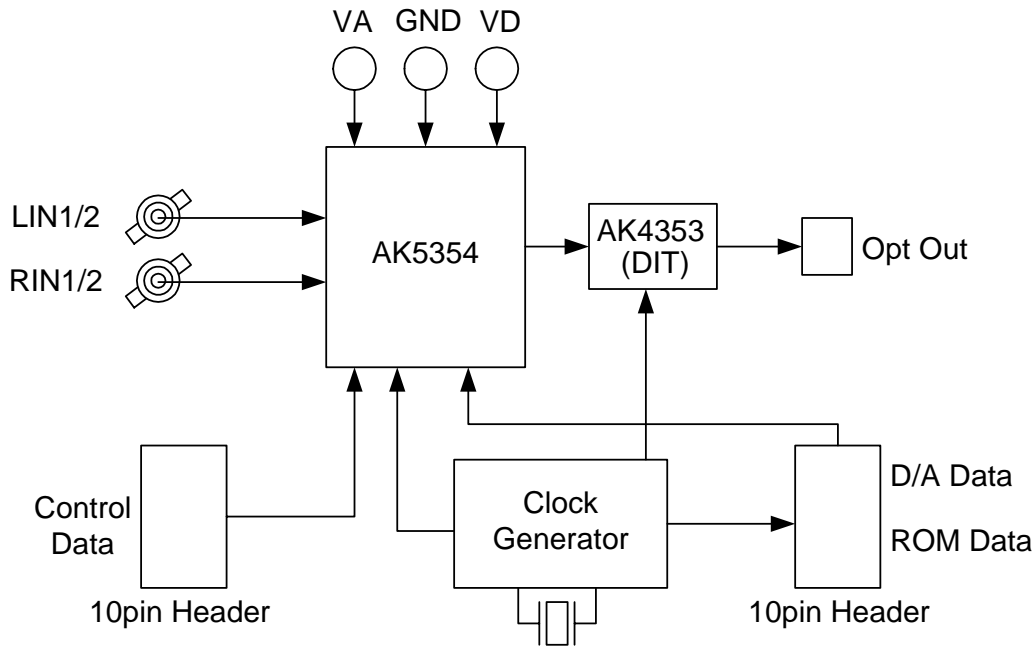

Figure 1. AKD5354 Block Diagram

\* Circuit diagram and PCB layout are attached at the end of this manual.

## 1. Evaluation Board Manual

### ■ Input circuit & Set-up jumper pin for Input circuits

#### (1) LINE Block

##### (a) LIN1,2/RIN1,2 Input circuit

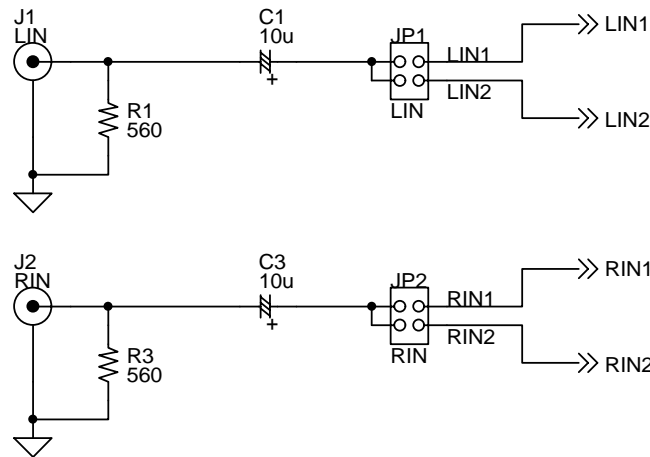
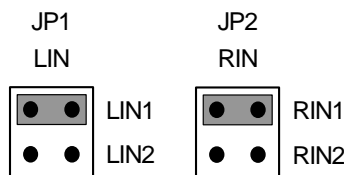
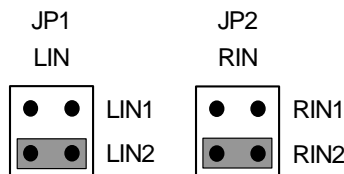

Figure 2. LIN1,2/RIN1,2 Input circuit on board

1. Analog signal is input to LIN1 and RIN1 pins via J1 and J2 connectors.



2. Analog signal is input to LIN2 and RIN2 pins via J1 and J2 connectors.



#### (2) Other Jumper pins

1. JP3 (VD) : VD of AK5354

VA : Supplied from “VA” connector via 10Ω.

VD : Supplied from “D2V” connector.

2. JP4 (GND) : Analog ground and Digital ground

open : separated

short : common (The connector “DGND” can be open.)

\* AKM assumes no responsibility for the trouble when using the circuit examples.

## ■ Operation sequence

### 1) Set up the power supply lines.

[VA]	(orange)	= 2.2 ~ 3.3V	: for VA of AK5354 (typ. 2.5V)
[D2V]	(orange)	= 1.8 ~ 3.3V	: for D2V of 74LVC541 (typ. 2.5V)
[VCC]	(red)	= 3.6 ~ 5.0V	: for logic
[AGND]	(black)	= 0V	: for analog ground (including VSS of AK5354)
[DGND]	(black)	= 0V	: for logic ground

Each supply line should be distributed from the power supply unit.  
D2V and VA must be same voltage level.

### 2) Set up the evaluation mode, jumper pins and DIP switches. (See the followings.)

Note : Evaluation mode of the AK5354 is fixed to I<sup>2</sup>S compatible on the board.

### 3) Power on.

The AK5354 and AK4353 should be reset once bringing SW1 = SW2 = "L" upon power-up.

## ■ Evaluation mode

### Applicable Evaluation Mode

- (1) Evaluation of A/D using DIT (Optical Link)
- (2) Evaluation of A/D using D/A converted data
- (3) All interface signals including master clock are fed externally.

#### (1) Evaluation of A/D using DIT (Optical Link)

PORT1 (DIT) is used. DIT generates audio bi-phase signal from received data and which is output through optical connector (TOTX176). It is possible to connect AKM's D/A converter evaluation boards on the digital-amplifier which equips DIR input. Nothing should be connected to PORT3 (ROM). In case of using external clock through a BNC connector (J3), select EXT on JP6 (CLK) and short JP5 (XTE) and open JP7 (EXT).

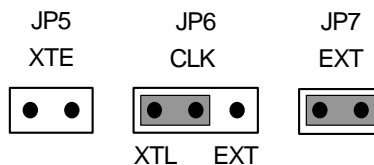

#### (2) Evaluation of A/D using D/A converted data

It is possible to make evaluation in the form of analog inputs and analog outputs by interfacing with various AKM's D/A evaluation boards with PORT3 (ROM).

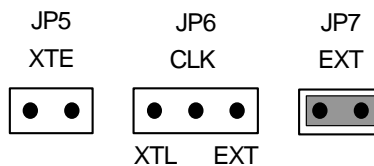

(3) All interface signals including master clock are fed externally.

Under the following set-up, all external signals needed for the AK5354 to operate could be fed through PORT3 (ROM).

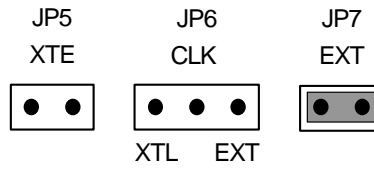

■ The function of the toggle SW

Upper-side is “H” and lower-side is “L”.

[SW1] (PDN): Resets the AK5354. Keep “H” during normal operation.

[SW2] (DIT): Resets the AK4353. Keep “H” during normal operation.

■ Serial Control

The AK5354 can be controlled via the printer port (parallel port) of IBM-AT compatible PC. Connect PORT2(CTRL) with PC by 10-line flat cable packed with the AKD5354.

Take care of the direction of connector. There is a mark pin#1 to connector.

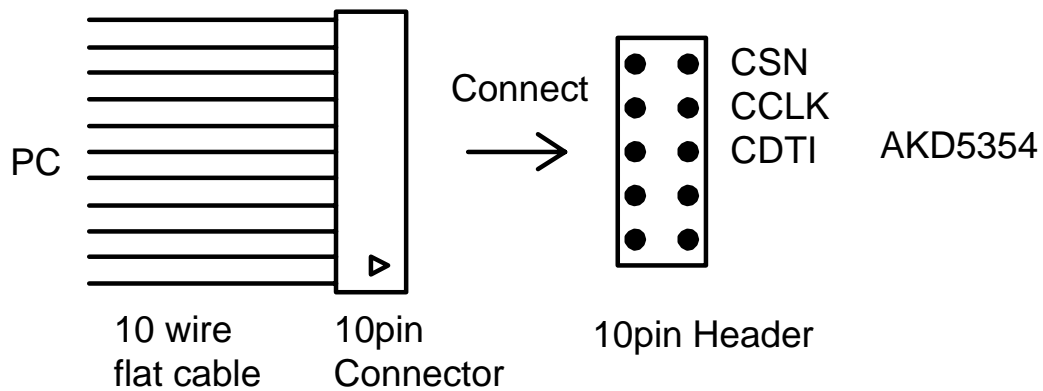

Figure 3. Connect of 10-line flat cable

## 2. Control Software Manual

### ■ Set-up of evaluation board and control software

1. Set up the AKD5354 according to previous term.
2. Connect IBM-AT compatible PC with AKD5354 by 10-line type flat cable (packed with AKD5354). Take care of the direction of 10pin header. (This control software does not operate on Windows NT, therefore please operate it on Windows95/98.)
3. Insert the floppy-disk labeled “AKD5354 Control Program ver 1.0” into the floppy-disk drive.
4. Access the floppy-disk drive and double-click the icon of “akd5354.exe” to set up the control program.
5. Then please evaluate according to the follows.

### ■ Explanation of each buttons

1. [Port Setup] : Set up the printer port.
2. [Write default] : Initialize the register of AK5354.
3. [Function1] : Dialog to write data by keyboard operation.
4. [Function2] : Dialog to evaluate IPGA.
5. [Write] : Dialog to write data by mouse operation.

Note : It is necessary to MCLK=256fs and I<sup>2</sup>S for audio data format in the beginning.  
Because AK4353 is fixed to MCLK=256fs and I<sup>2</sup>S for audio data format.

## ■ Explanation of each dialog

1. [Function1 Dialog] : Dialog to write data by keyboard operation

Address Box: Input register address in 2 figures of hexadecimal.

Data Box: Input register data in 2 figures of hexadecimal.

If you want to write the input data to AK5354, click "OK" button. If not, click "Cancel" button.

2. [Function2 Dialog] : Dialog to evaluate IPGA

This dialog corresponds to only addr=03H.

Address Box: Input register address in 2 figures of hexadecimal.

Start Data Box: Input start data in 2 figures of hexadecimal.

End Data Box: Input end data in 2 figures of hexadecimal.

Interval Box: Data is written to AK5354 by this interval.

Step Box: Data changes by this step.

Mode Select Box:

If you check this check box, data reaches end data, and returns to start data.

[Example] Start Data = 00, End Data = 09

Data flow: 00 01 02 03 04 05 06 07 08 09 09 08 07 06 05 04 03 02 01 00

If you do not check this check box, data reaches end data, but does not return to start data.

[Example] Start Data = 00, End Data = 09

Data flow: 00 01 02 03 04 05 06 07 08 09

If you want to write the input data to AK5354, click "OK" button. If not, click "Cancel" button.

3. [Write Dialog] : Dialog to write data by mouse operation

There are dialogs corresponding to each register.

Click the "Write" button corresponding to each register to set up the dialog. If you check the check box, data becomes "H" or "1". If not, "L" or "0".

If you want to write the input data to AK5354, click "OK" button. If not, click "Cancel" button.

## ■ Operation flow

Keep the following flow surely.

1. Set up the control program according to explanation above.
2. Click "Port Setup" button.
3. Click "Write default" button.
4. Then set up the dialog and input data.

**■ Indication of data**

Input data is indicated on the register map. Red letter indicates “H” or “1” and blue one indicates “L” or “0”. Blank is the part that is not defined in the datasheet.

**■ Attention on the operation**

If you set up Function1 or Function2 dialog, input data to all boxes. Attention dialog is indicated if you input data or address that is not specified in the datasheet or you click “OK” button before you input data. In that case set up the dialog and input data once more again. These operations does not need if you click “Cancel” button or check the check box.

<b>MEASUREMENT RESULTS</b>
----------------------------

[Measurement condition 1]

- Measurement unit : Audio Precision, System two
- MCLK : 256fs
- BCLK : 64fs
- fs : 44.1kHz
- Bit : 20bit
- Power Supply : VA = VD = 2.5V
- Interface : DIT
- Temperature : Room

Parameter	Input pin	Result (Lch / Rch)	Unit
<b>ADC Analog Input Characteristics</b>			
S/(N+D) (-0.5dB Input)	LIN1 / RIN1	85.3 / 85.5	dB
	LIN2 / RIN2	85.3 / 85.6	dB
D-Range (A-weighted)	LIN1 / RIN1	89.0 / 89.0	dB
	LIN2 / RIN2	89.0 / 89.0	dB
S/N (A-weighted)	LIN1 / RIN1	89.0 / 89.0	dB
	LIN2 / RIN2	89.0 / 89.0	dB
Interchannel Isolation	LIN1 / RIN1	110.6 / 109.6	dB
	LIN2 / RIN2	111.1 / 111.8	dB



[Plot]

AKM

AK5354 THD+N vs. Input Level  
VA=VD=2.5V, fs=44.1kHz, fin=1kHz

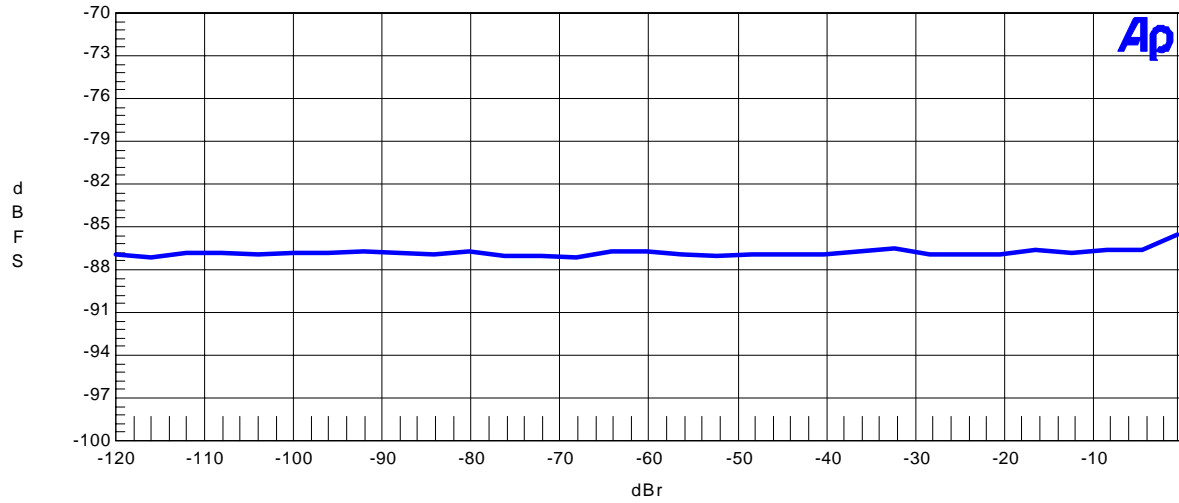

Figure 1. THD+N vs. Input Level

AKM

AK5354 THD+N vs. Input Frequency  
VA=VD=2.5V, fs=44.1kHz, Input=-0.5dBr

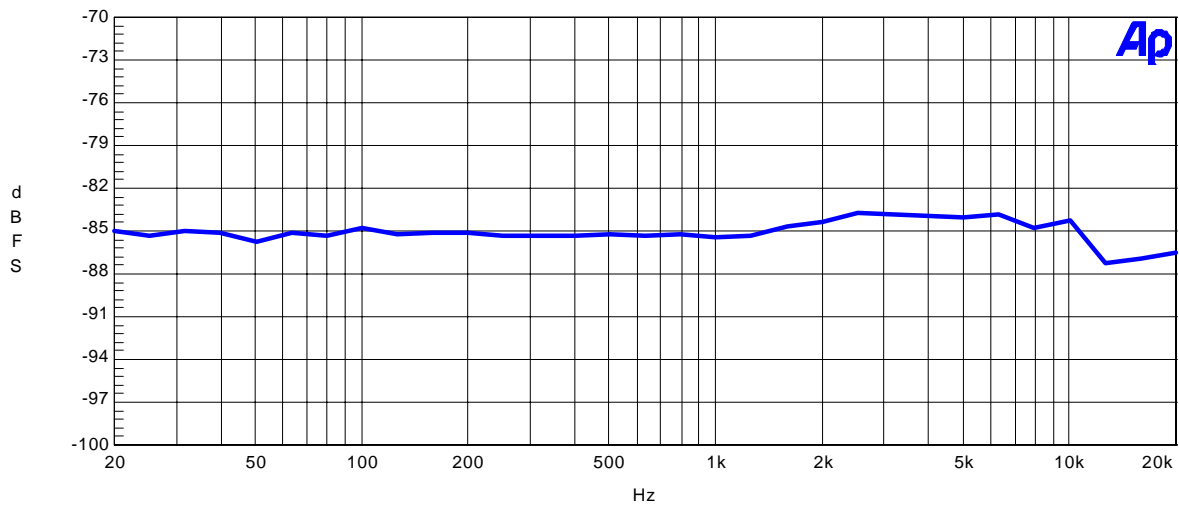

Figure 2. THD+N vs. Input Frequency

AKM

AK5354 Linearity  
 VA=VD=2.5V, fs=44.1kHz, fin=1kHz

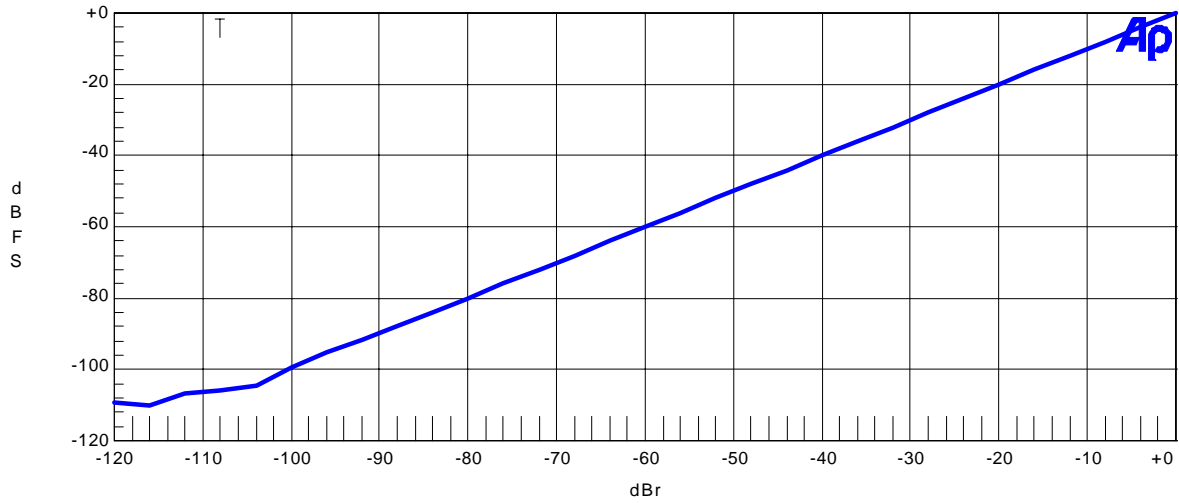

Figure 3. Linearity

AKM

AK5354 Frequency Response  
 VA=VD=2.5V, fs=44.1kHz, Input=-0.5dBr

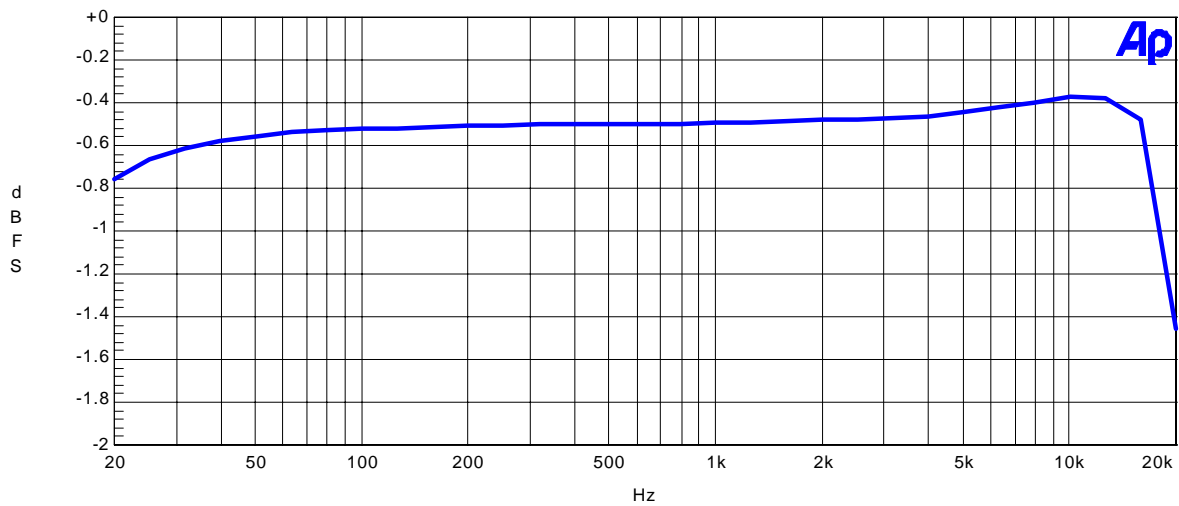

Figure 4. Frequency Response

AKM

AK5354 Crosstalk  
VA=VD=2.5V, fs=44.1kHz, Input=-0.5dBr

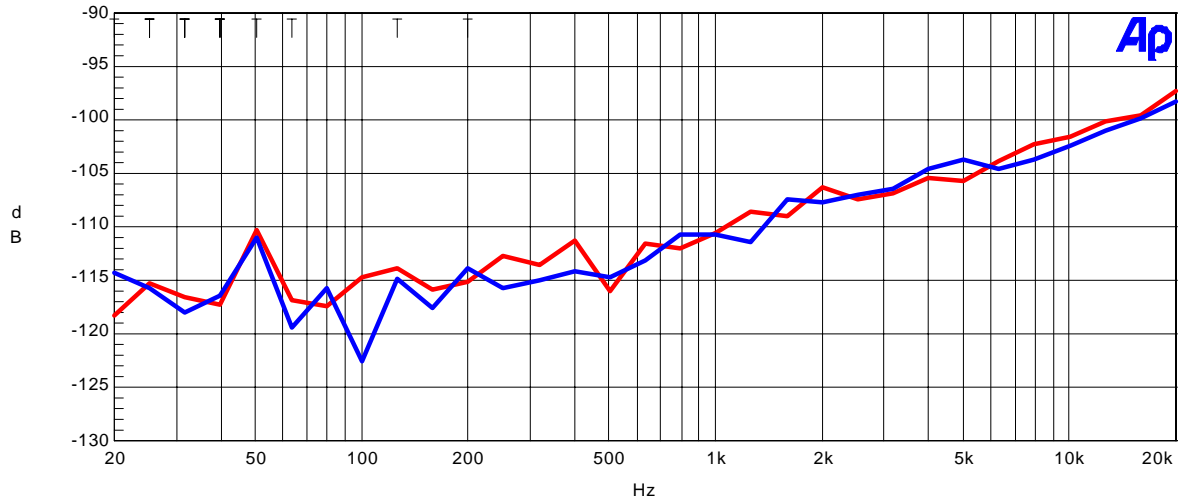

Figure 5. Crosstalk

AKM

AK5354 FFT Plot  
VA=VD=2.5V, fs=44.1kHz, Input=-0.5dBr, fin=1kHz

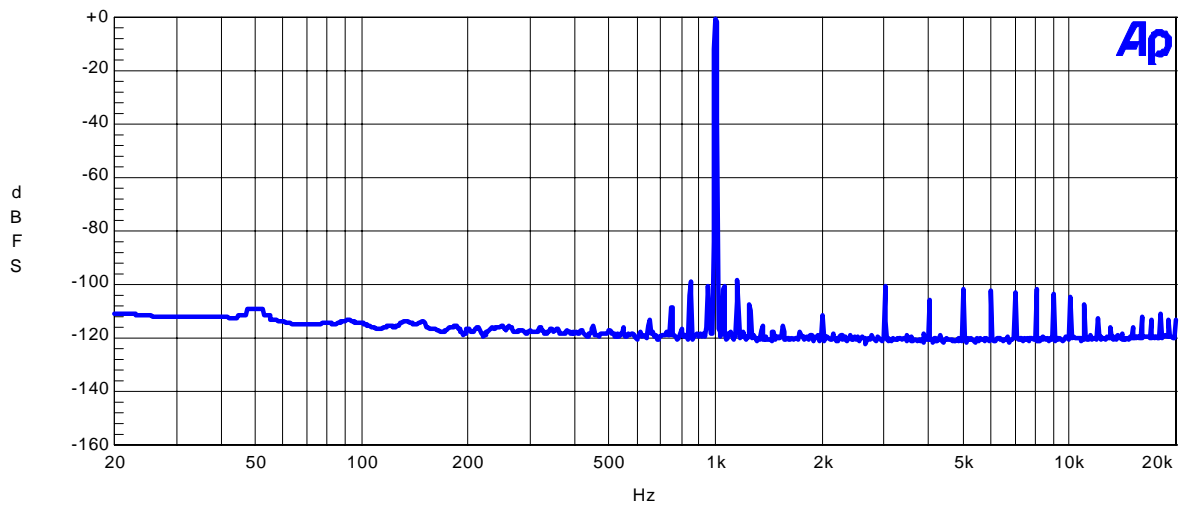

Figure 6. FFT Plot

AKM

AK5354 FFT Plot  
VA=VD=2.5V, fs=44.1kHz, Input=-60dBr, fin=1kHz

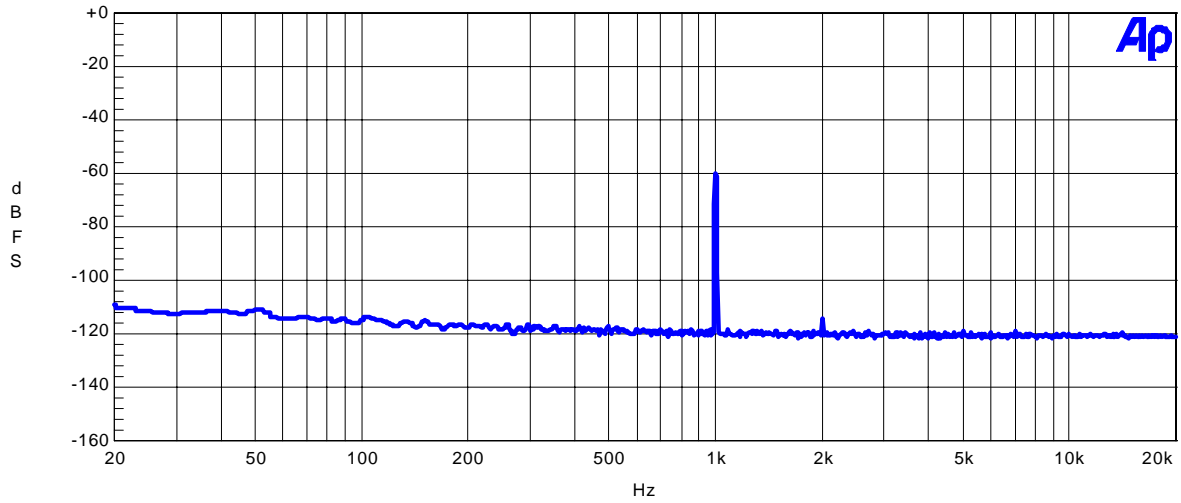

Figure 7. FFT Plot

AKM

AK5354 FFT Plot  
VA=VD=2.5V, fs=44.1kHz, fin=None

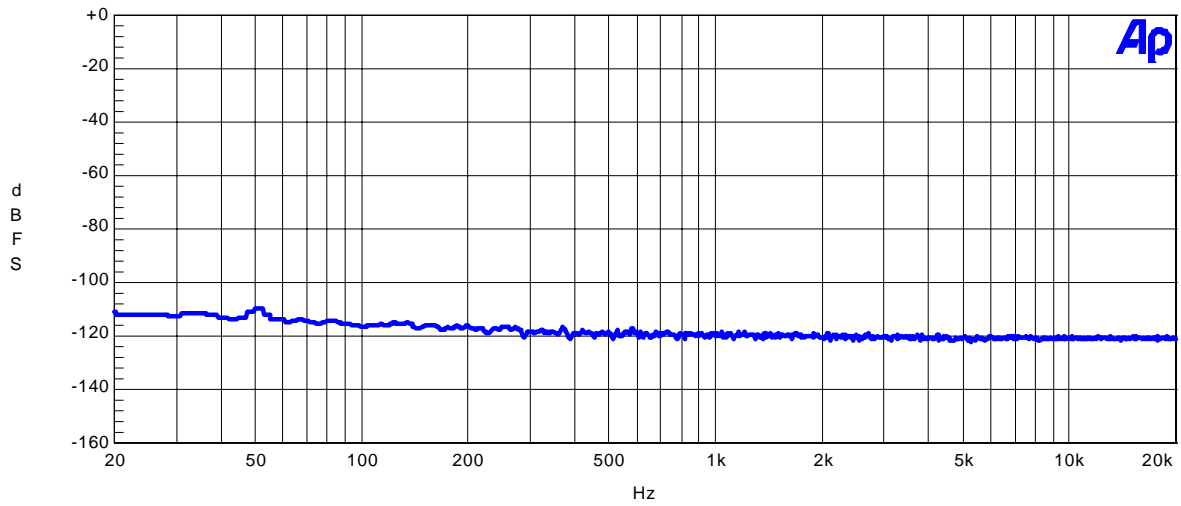
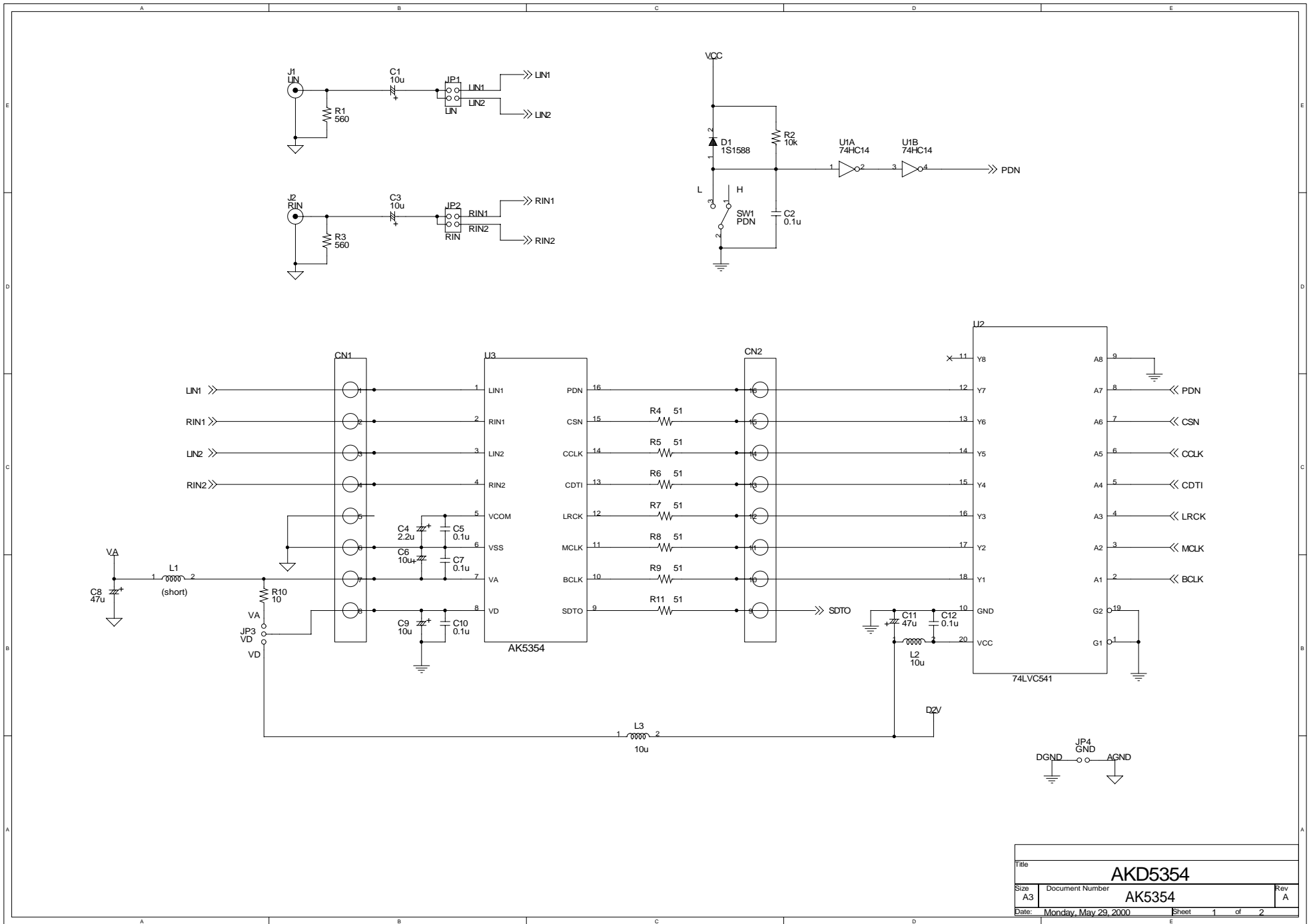
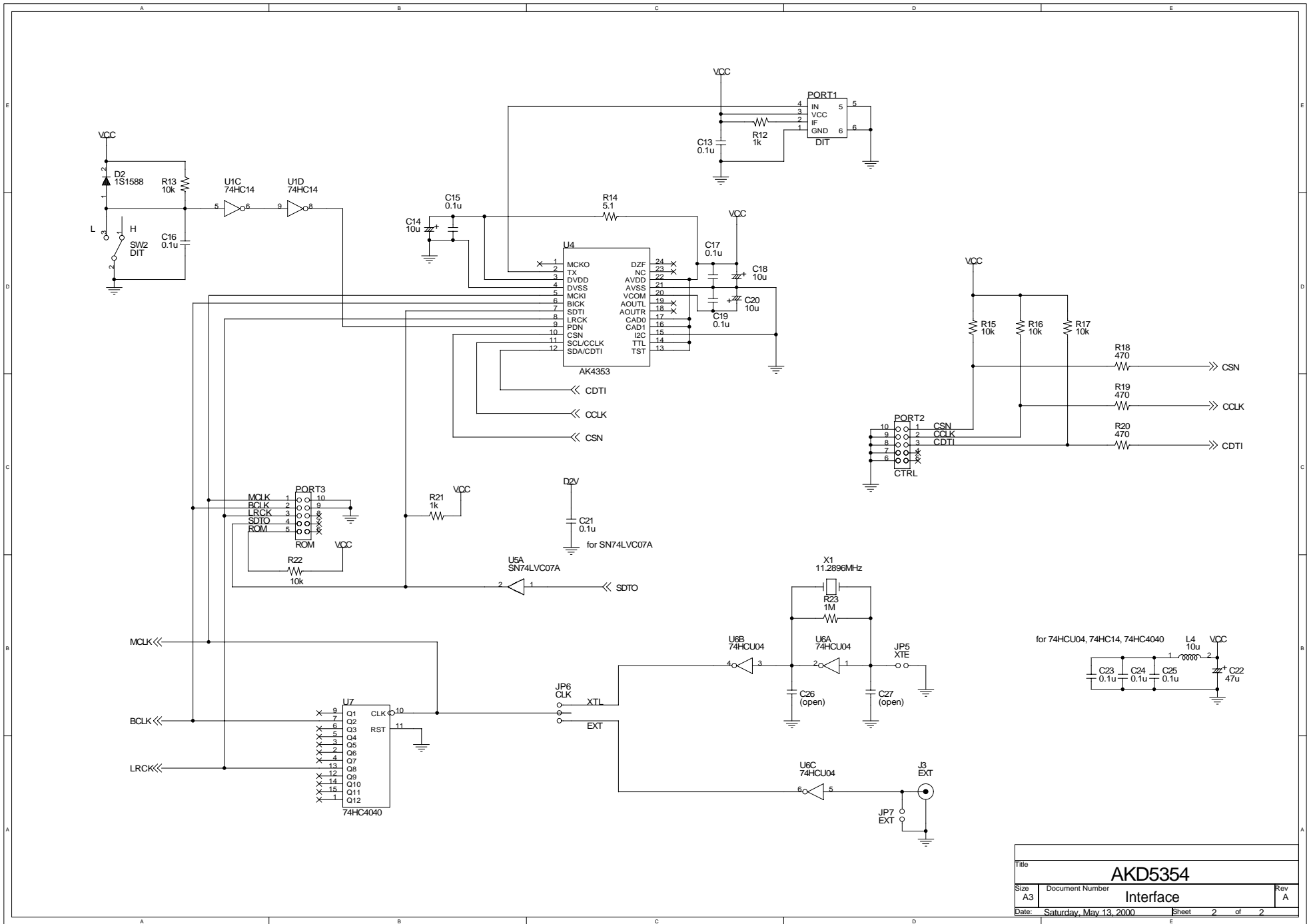
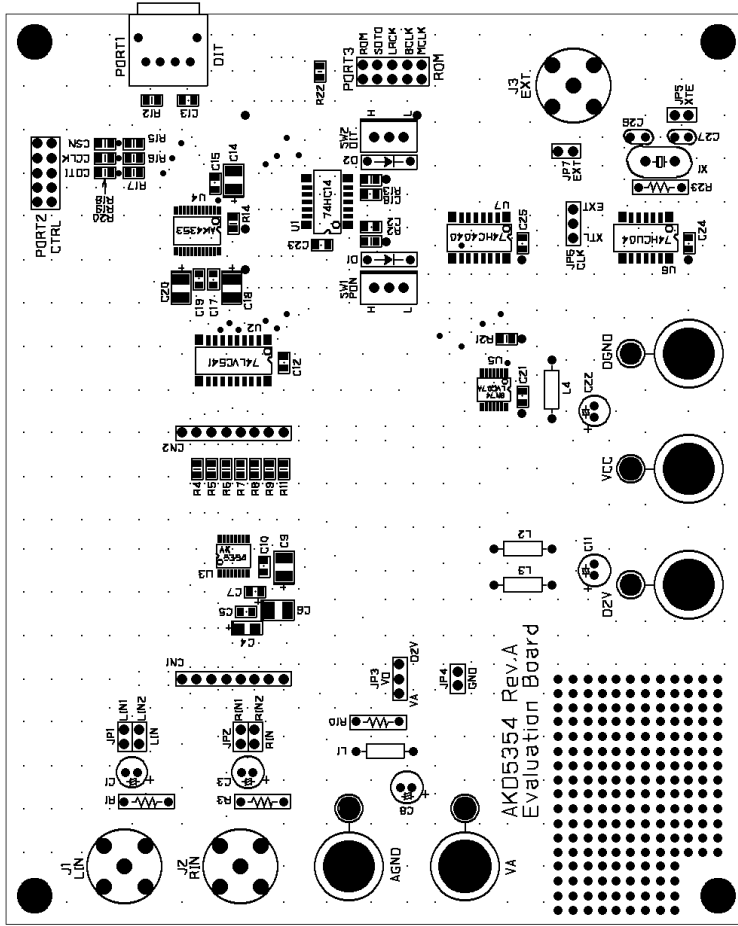

Figure 8. FFT Plot



Title		
<b>AKD5354</b>		
Size	Document Number	Rev
A3	AK5354	A
Date:	Monday, May 29, 2000	Sheet 1 of 2





AKD5354 Rev.A L1 SR SILK

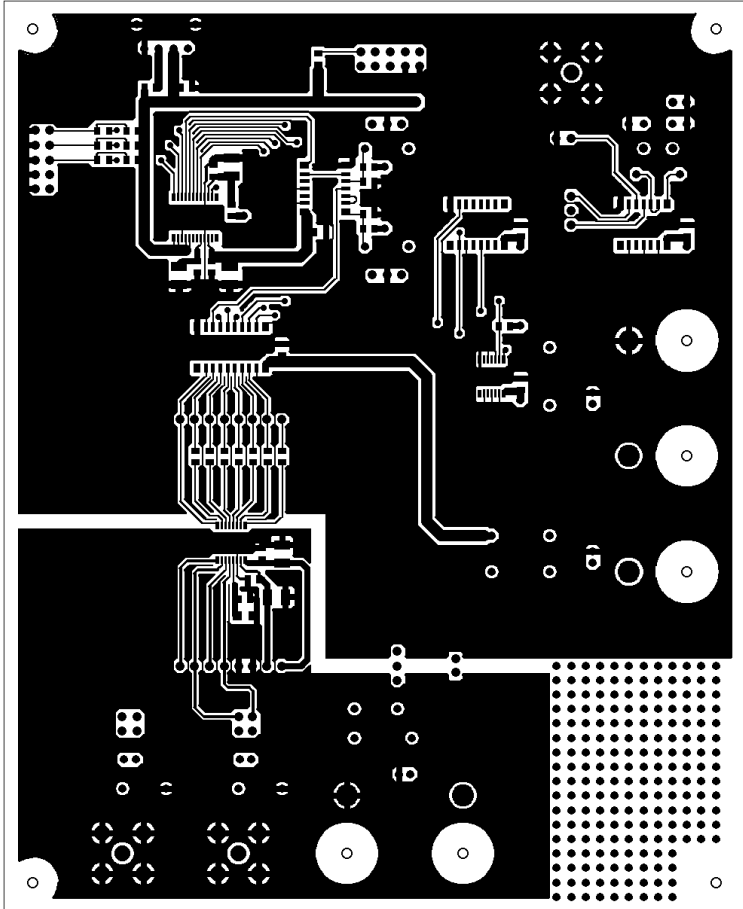

AKD5354 Rev.A L1



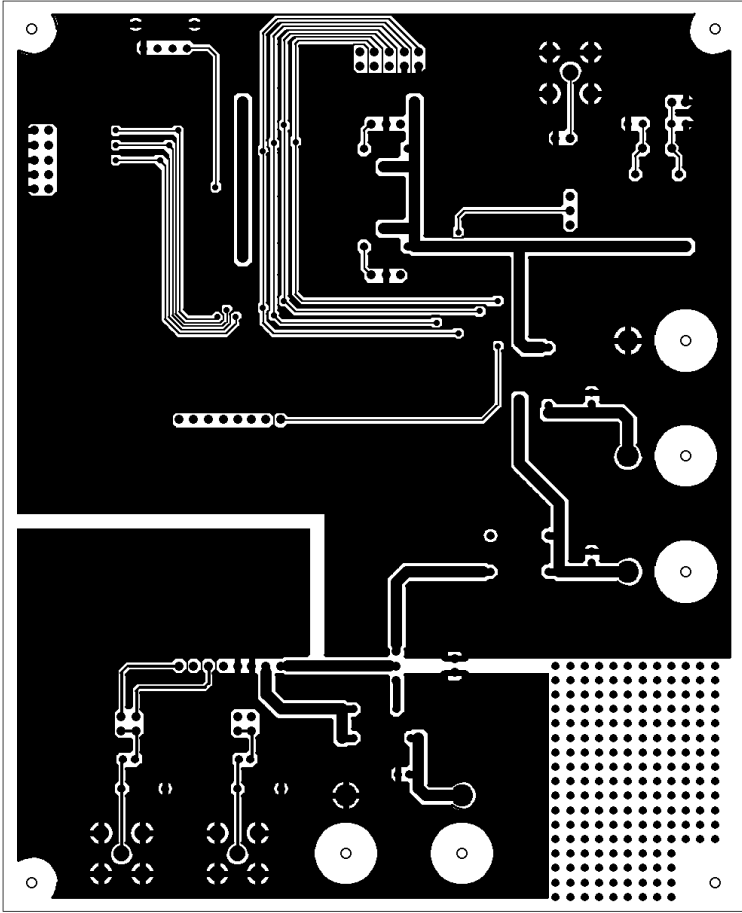

AKD2324 Rev.A TS

#### IMPORTANT NOTICE

- These products and their specifications are subject to change without notice. Before considering any use or application, consult the Asahi Kasei Microsystems Co., Ltd. (AKM) sales office or authorized distributor concerning their current status.
- AKM assumes no liability for infringement of any patent, intellectual property, or other right in the application or use of any information contained herein.
- Any export of these products, or devices or systems containing them, may require an export license or other official approval under the law and regulations of the country of export pertaining to customs and tariffs, currency exchange, or strategic materials.
- AKM products are neither intended nor authorized for use as critical components in any safety, life support, or other hazard related device or system, and AKM assumes no responsibility relating to any such use, except with the express written consent of the Representative Director of AKM. As used here:
  - a. A hazard related device or system is one designed or intended for life support or maintenance of safety or for applications in medicine, aerospace, nuclear energy, or other fields, in which its failure to function or perform may reasonably be expected to result in loss of life or in significant injury or damage to person or property.
  - b. A critical component is one whose failure to function or perform may reasonably be expected to result, whether directly or indirectly, in the loss of the safety or effectiveness of the device or system containing it, and which must therefore meet very high standards of performance and reliability.
- It is the responsibility of the buyer or distributor of an AKM product who distributes, disposes of, or otherwise places the product with a third party to notify that party in advance of the above content and conditions, and the buyer or distributor agrees to assume any and all responsibility and liability for and hold AKM harmless from any and all claims arising from the use of said product in the absence of such notification.