



AKD5393

Evaluation board Rev.A for AK5393

General description

The AKD5393 is an evaluation board for the AK5393 professional audio 24bit A/D converter. The AKD5393 includes the input buffer circuit and also has a digital interface transmitter. Further, the AKD5393 can evaluate direct interface with AKM's DAC evaluation boards.

■ Ordering guide

AKD5393 Rev.A --- Evaluation board for AK5393VS

Function

- On-board Full-differential input buffer circuit
- On-board clock generator
- Compatible with 2 types of interface
 - 1) Direct interface with AKM's DAC evaluation boards.
 - 2) On-board CS8402 as DIT which transmits optical output.
- A BNC connector for an external clock input.

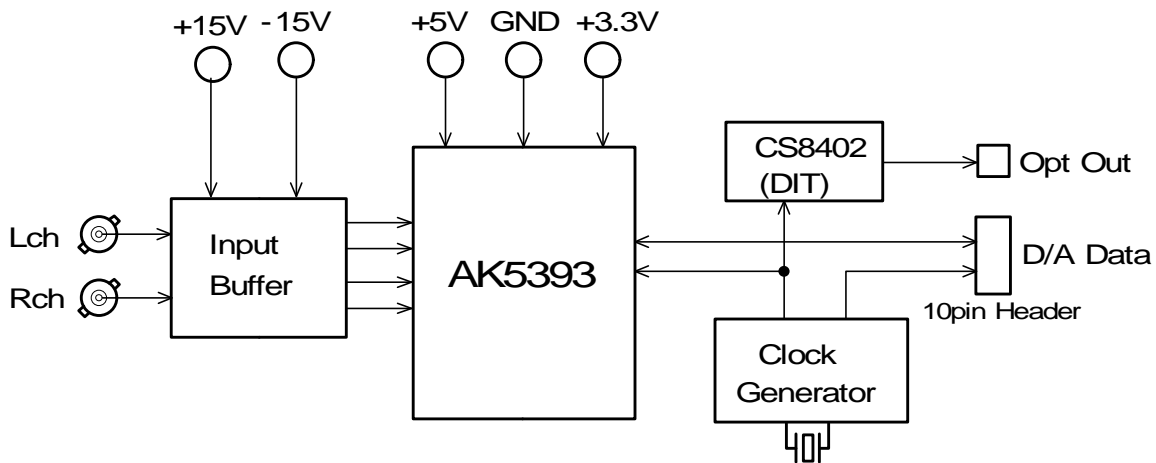

* Circuit diagram and PCB layout are attached at the end of this manual.

■ Input buffer circuit

The AKD5393 includes full-differential input buffer circuit with an inverted-amp (gain: -10dB). The capacitor of 10nF between AIN+ /- decreases the clock feed through noise of modulator, and composes a 1st order LPF (fc=360kHz) with 22ohm resistor before the capacitor. This circuit also has a 1st order LPF (fc=370kHz) composed of op-amp. External analog signal can be fed through the BNC connector or the Cannon connector.

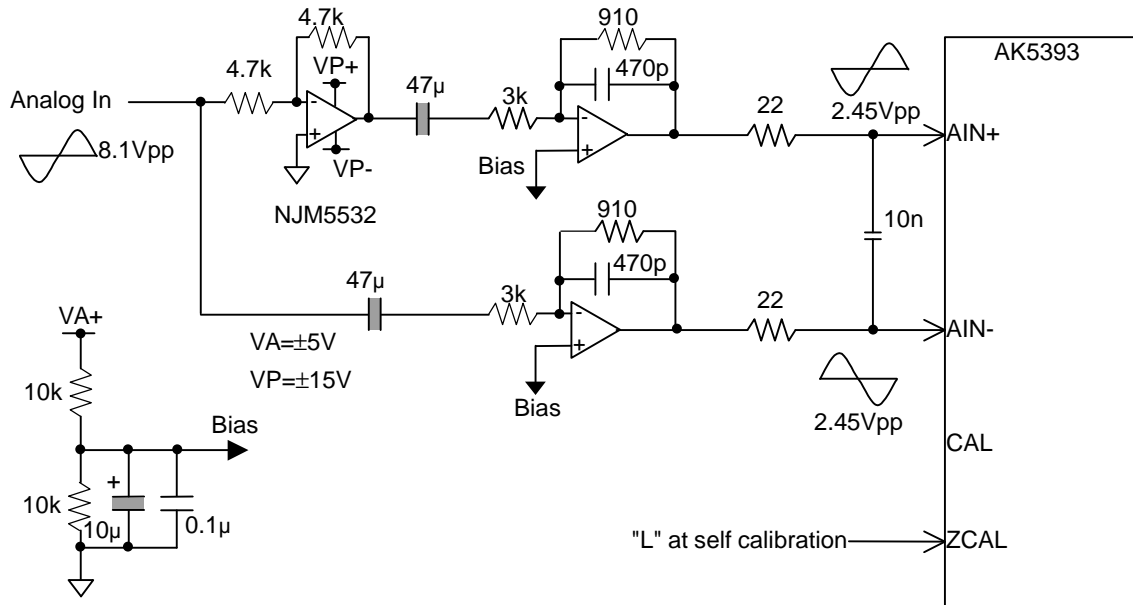

Figure 1. Full-differential input buffer circuit example

1: In case of using the BNC connector

- [JP2, JP3, JP4, JP5]: Short
- [R11, R18]: Open

The resistor value of R10 and R19 should be properly selected in order to match the output impedance of the signal source.

2: In case of using the Cannon connector

- [JP2, JP3, JP4, JP5]: Open

The resistor value of R10, R11, R18 and R19 should be properly selected in order to match the output impedance of the signal source.

* AKM assumes no responsibility for the trouble when using the above circuit examples.

■ Power supply and Decoupling

VA and VD supplies to the AK5393 are decoupled separately in order to minimize the effect of the digital noise. A system analog supply is fed to VA. VA and VD lines should be distributed separately from the power unit. Decoupling capacitors are connected to AK5393 as near as possible, particularly the ceramic capacitor to the VREFL/R pin.

■ **Operation sequence**

- (1) Set up the power supply lines
 VP+=+15V, VP- = -15V, VA+=+5V, VD+=+3.3V~5.25V, AGND=DGND=0V
 Each supply line should be distributed from the power unit.
- (2) Set up the evaluation modes and jumper pins. (See next item)
 There are many jumper pins to cover many evaluation modes.
 Please take care of setting.
- (3) Set up the DIP SW position for the DIT. (See next item)
 This does not affect AK5393 operation.
- (4) Power On.
 The AK5393 should be reset once by bringing PD "L"(SW4) upon power-up.
- (5) AK5393 can be reset by SW4 during operation.
 Lower position resets the device, and the upper position is for normal operation.

Note: In any case of changing clocks during operation, the device should be reset by bringing PD "L". If not followed, the AK5393 may be destroyed since its internal logic uses dynamic circuit.

■ **The evaluation modes and corresponding jumper pin settings.**

1. Evaluation Mode

Applicable Evaluation Mode

- 1-1 Using D/A converter board for the analog performance analysis.
- 1-2 DIT (Optical Link) [Default]
- 1-3 All interface signals (MCLK, BICK and LRCK) are fed from external circuit.
- 1-4 Feed all interface signals to the external circuit through PORT2.

1-1. Using D/A converter board for the analog performance analysis.

The AK5393 can be evaluated by distortion analyzer using various AKM's D/A converter evaluation boards through PORT2.

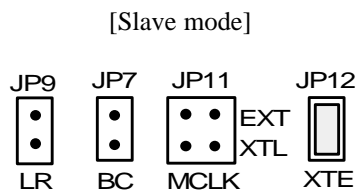
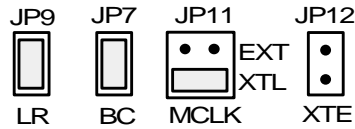

Figure 2. Jumper set up (D/A)

1-2DIT (Optical Link)

PORT1 is used. DIT generates audio Bi-phase signal from received data and which is output through optical connector (TOTX174). It is possible to connect AKM's D/A converter evaluation boards on the digital-amplifier, which equips DIR input. There are two kinds of jumper setting depend on the SMODE1 and SMODE2 pin. The interface signals are output from PORT2. (See the (4)). In case of using external clock through a BNC connector, select EXT on JP11 (MCLK) and short JP12 (XTE).

[Slave mode] (Default)



[Master mode]

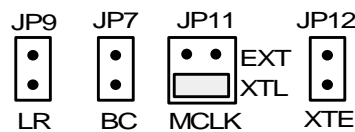

Figure 3. Jumper set up (DIT)

1-3 All interface signals (MCLK, BICK and LRCK) are fed from external circuit. [Slave mode]

Under the following setup, MCLK, LRCK and SCLK signals needed for the A/D to operate could be Fed through PORT2.

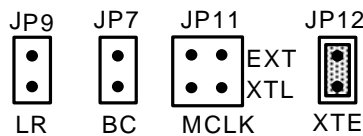

Figure 4. Jumper set up (EXT)

1-4 Feed all interface signals to the external circuit through PORT2. [Master, Slave mode]

Please set up as same as 1-2. All interfacing signal which drive AK5393 are output through PORT2. However, the FSYNC signal is input when the position of the SDATA is needed to be controlled.

* Setting for double speed sampling (fs=96kHz)

For the double speed sampling, DFS="L", MCLK=128fs, BICK=64fs(max) are required.

So, when BICK and LRCK are created from 74HC4040 on the board, the crystal oscillator should be changed to 24.576MHz and set JP14 (MCLK2) to 128fs side (see the schematics).

2. BIT CLK (BCF) set up

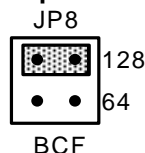

[JP8] Either 64fs or 128fs for the BCF can be selected. Figure shows 128fs example.

When DFS="H", set JP8 to 64 side.

128: 128fs is fed to AK5393 as BICK.

64: 64fs is fed to AK5393 as BICK.

3. Jumper-set up and explanation

Set up the CS8402's data format corresponding the serial data interface of the AK5393.

AKD5393 Data Format	S.MODE2 (SW2-5)	S.MODE1 (SW2-4)	8402 (SW2-1)	BCF (JP6)	LRP (JP10)
Slave mode	ON	ON	ON	F	H
Master mode	ON	OFF	OFF	R	L
I ² S Slave mode	OFF	ON	OFF	R	H
I ² S master mode	OFF	OFF	OFF	R	H

*DIP-SW is ON="L"
OFF="H"

Table 1. Serial data interface of AK5393 and CS8402

[SW2-1]: CS8402's data format

ON: MSB justified, 24bit

OFF: IIS Compatible

[JP6]: Define the polarity of SCLK.

F: SCLK is inverted.

R: SCLK coincides with AK5393

[JP10]: Define the polarity of LRCK.

L: LRCK is inverted.

H: LRCK coincides with AK5393.

4. The other function set up

No.	PIN	ON	OFF
1	8402	See the Table1.	
2	DFS	48k	96k
3	HPFE	disable	enable
4	SM1	See the Table 1.	
5	SM2		
6	CALMODE	VCOM	AIN

*DIP-SW is ON="L" OFF="H"

→Selects the sampling rate.

→Selects HPF of AK5393.

→Selects the reference signal for Offset-Cal of K5383

Table 2. DIP-SW2 set-up

VCOM: VCOML, VCOMR pin

AIN: Analog input pin (AINL±, AINR±)

[JP13]: Selects the analog power supply source to VA pin of the AK5393.

Open: Supply from the power supply terminal (VA+).

Short: Supply from 3-terminal-voltage regulator (+5V) on the board.

■ The function of the toggle SW.

[SW3] Resets the CS8402. Upper position resets the internal counter of CS8402, then Bi-phase signal is not output. Keep the "L" position during normal operation.

[SW4] Resets the AK5393. Keep the "H" position during conversion.

■ DIP switch set up. (Default is the consumer mode.)

The DIP-SW1 sets the C-bit of CS8402. This set up does not affect the evaluation of the AK5383. In case of using DIT, need to set it up correctly. For more detailed configurations, please refer to the CS8402 datasheet.

Switch	OFF=0,ON=1	Contents
8	$\overline{\text{PRO}} = 0$	Professional mode, C0=1
7,6	$\overline{\text{C6}}, \overline{\text{C7}}$	C6,C7 - Sampling frequency
	11	00 - Not indicated. Receiver default to 48kHz.
	10	01 - 48kHz
	01	10 - 44.1kHz
	00	11 - 32kHz
5	$\overline{\text{C9}}$	C8,C9,C10,C11 - 1bit of channel mode
	1	0000 - Mode not indicated. Receiver default to 2-channel mode.
	0	0100 - Stereophonic.
4	$\overline{\text{C1}}$	C1 - Audio mode
	1	0 - Normal audio
	0	1 - Not audio
3	TRNPT	Transparent mode *CS8402 is CRE
	0	Normal mode
	1	Transparent mode
1,2	$\overline{\text{EM1}}, \overline{\text{EM0}}$	C2,C3,C4 - Encoded audio signal emphasis
	1 1	000 - Emphasis not indicated. Receiver defaults to no emphasis with manual override enable.
	1 0	100 - None
	0 1	110 - 50/15usec
	0 0	111 - CCITT J.17

Table 3. DIP switch set up of CS8402 (Professional mode)

Switch	OFF=0,ON=1	Contents
8	$\overline{\text{PRO}} = 0$	Consumer mode, C0=0 (Default)
7	$\overline{\text{C2}}$	C2 - Copy
	1	0 - Copy inhibited
Default	0	1 - Copy permitted
6	$\overline{\text{C3}}$	C3,C4,C5 - Pre-emphasis
	1	000 - None
Default	0	100 - 50/15usec
5	$\overline{\text{C15}}$	C15 - Generation Status
	1	0 - See the standard
Default	0	1 - See the standard
3,4	$\overline{\text{FC1}}, \overline{\text{FC0}}$	C24,C25,C26,C27- Sampling frequency
	00	0000 - 44.1kHz
	01	0100 - 48kHz
Default	10	1100 - 32kHz
	11	0000 - 44.1kHz, CD mode
1,2	$\overline{\text{C8}}, \overline{\text{C9}}$	C8-C14 - Category code
	1 1	0000000 - General
Default	1 0	0100000 - PCM encoder/decoder
	0 1	1000000 - CD
	0 0	1100000 - DAT

Table 4. DIP switch set up of CS8402 (Consumer mode)

IMPORTANT NOTICE

- These products and their specifications are subject to change without notice. Before considering any use or application, consult the Asahi Kasei Microsystems Co., Ltd. (AKM) sales office or authorized distributor concerning their current status.
- AKM assumes no liability for infringement of any patent, intellectual property, or other right in the application or use of any information contained herein.
- Any export of these products, or devices or systems containing them, may require an export license or other official approval under the law and regulations of the country of export pertaining to customs and tariffs, currency exchange, or strategic materials.
- AKM products are neither intended nor authorized for use as critical components in any safety, life support, or other hazard related device or system, and AKM assumes no responsibility relating to any such use, except with the express written consent of the Representative Director of AKM. As used here:
 - (a) A hazard related device or system is one designed or intended for life support or maintenance of safety or for applications in medicine, aerospace, nuclear energy, or other fields, in which its failure to function or perform may reasonably be expected to result in loss of life or in significant injury or damage to person or property.
 - (b) A critical component is one whose failure to function or perform may reasonably be expected to result, whether directly or indirectly, in the loss of the safety or effectiveness of the device or system containing it, and which must therefore meet very high standards of performance and reliability.
- It is the responsibility of the buyer or distributor of an AKM product who distributes, disposes of, or otherwise places the product with a third party to notify that party in advance of the above content and conditions, and the buyer or distributor agrees to assume any and all responsibility and liability for and hold AKM harmless from any and all claims arising from the use of said product in the absence of such notification.

AK5393 Measurement Result

[Measurement condition]

- Measurement unit : ROHDE & SCHWARZ, UPD04
- fs : 48kHz, 96kHz
- BW : 20Hz~20kHz (fs=48kHz), 40Hz~40kHz (fs=96kHz)
- Power Supply : AVDD=3.3V, DVDD=5V
- Interface : DIT (fs=48kHz), Serial Multiplex (fs=96kHz)
- Temperature : Room

fs	48kHz	96kHz	BW, filter
THD+N(-1dB)	-106.1	-106.0	20Hz~20kHz
	-	-103.3	40Hz~40kHz
DR(-60dB)	114.0	113.5	20Hz~20kHz
	117.2	115.5	20Hz~20kHz, A-weighted
	-	105.1	40Hz~40kHz
S/N	114.0	113.5	20Hz~20kHz
	117.2	115.5	20Hz~20kHz, A-weighted
		105.1	40Hz~40kHz
unit	[dB]	[dB]	

■ Plot

fs=48kHz

- Figure 1. FFT (Input Level = -1dB)
- Figure 2. FFT (Input Level = -60dB)
- Figure 3. FFT (Input Level = -120dB)
- Figure 4. FFT (Input = "0" data)
- Figure 5. THD+N vs Input Frequency (Input level=-1dB)
- Figure 6. THD+N vs Input Level (fin=1kHz)
- Figure 7. Linearity
- Figure 8. Frequency Response
- Figure 9. Crosstalk

fs=96kHz

- Figure 10. FFT (Input Level = -1dB)
- Figure 11. FFT (Input Level = -60dB)
- Figure 12. FFT (Input Level = -120dB)
- Figure 13. FFT (Input = "0" data)
- Figure 14. THD+N vs Input Frequency (Input level=-1dB)
- Figure 15. THD+N vs Input Level (fin=1kHz)
- Figure 16. Linearity
- Figure 17. Frequency Response
- Figure 18. Crosstalk

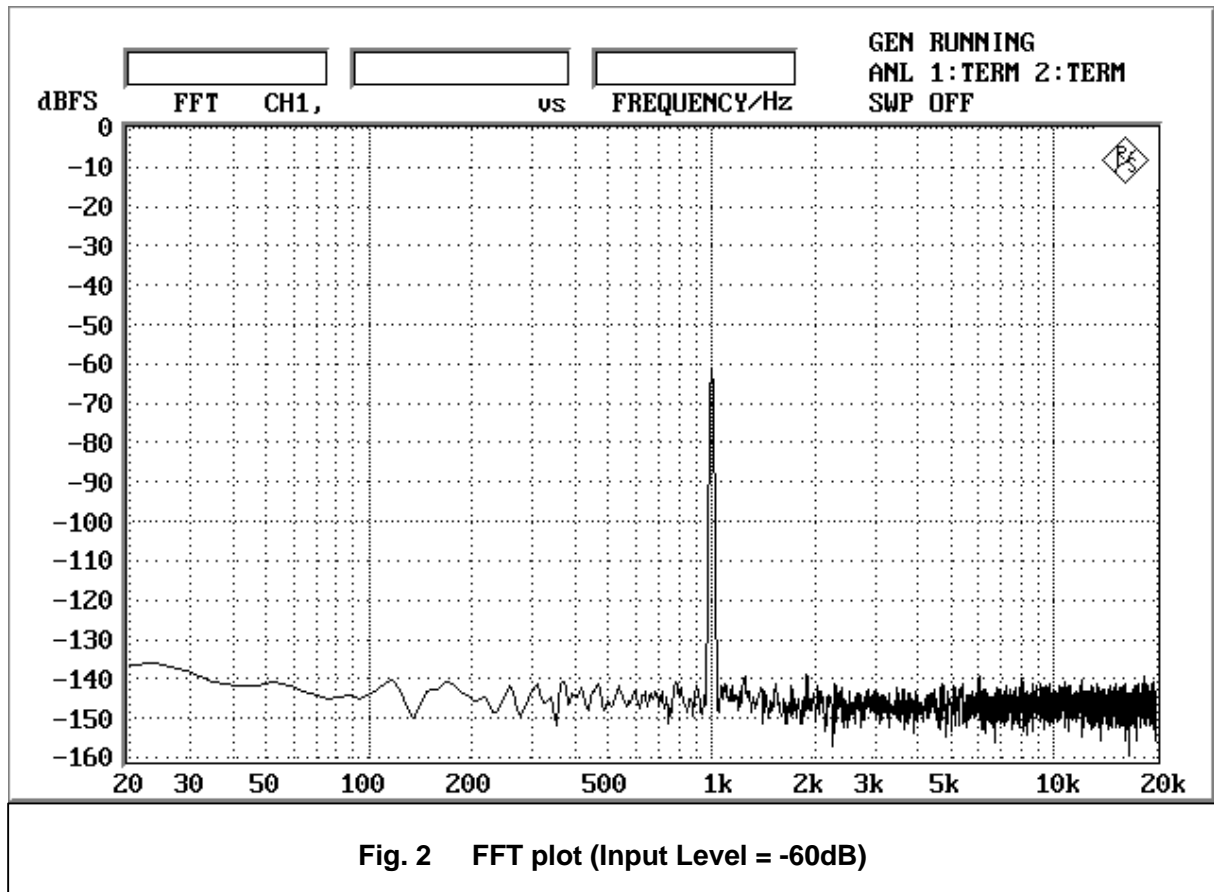
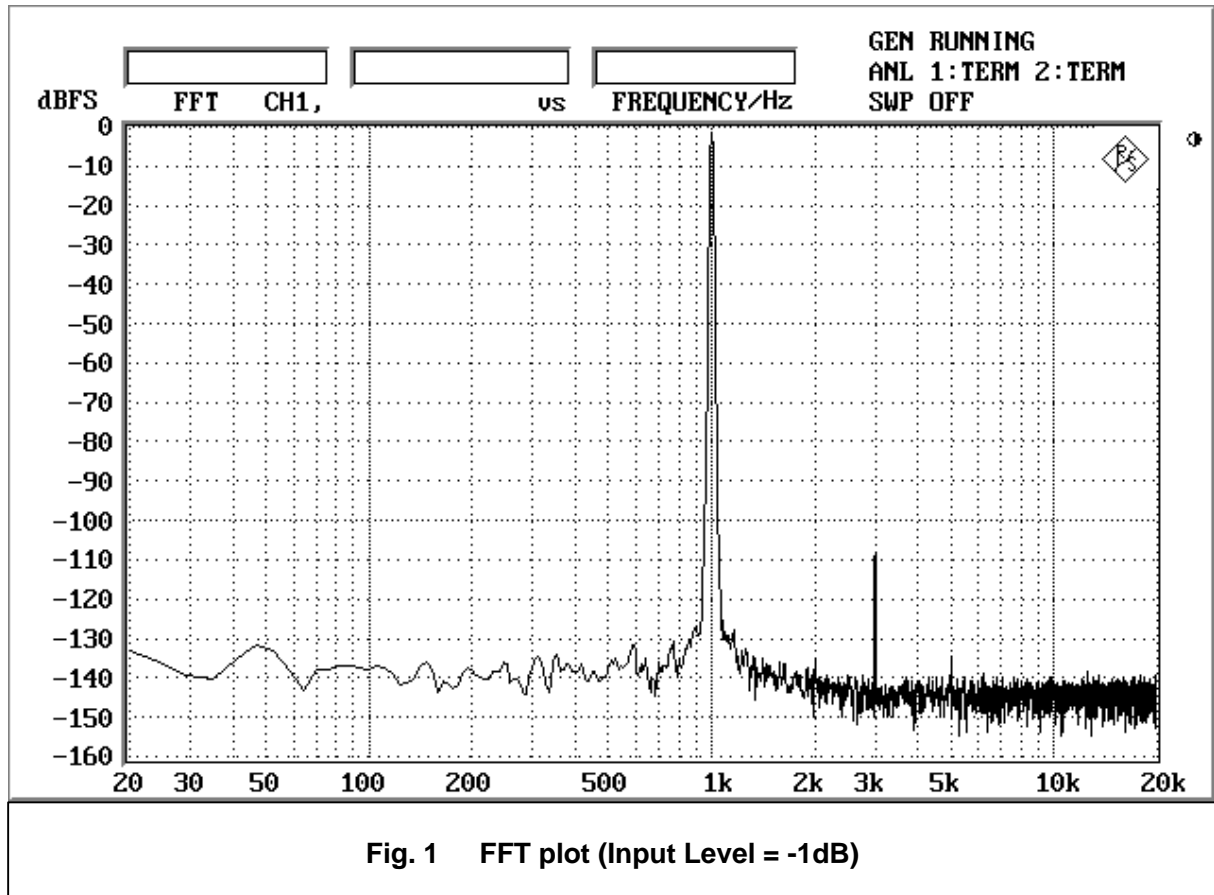

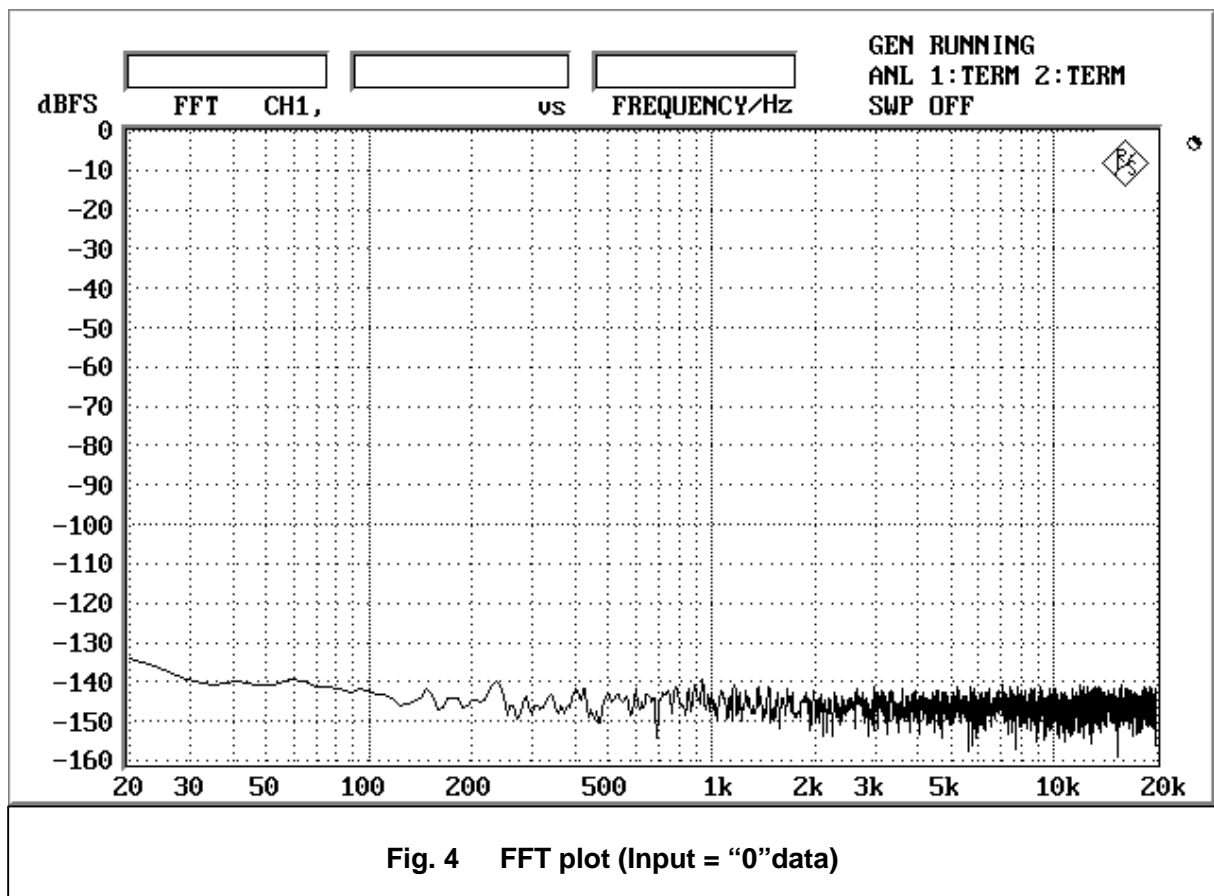
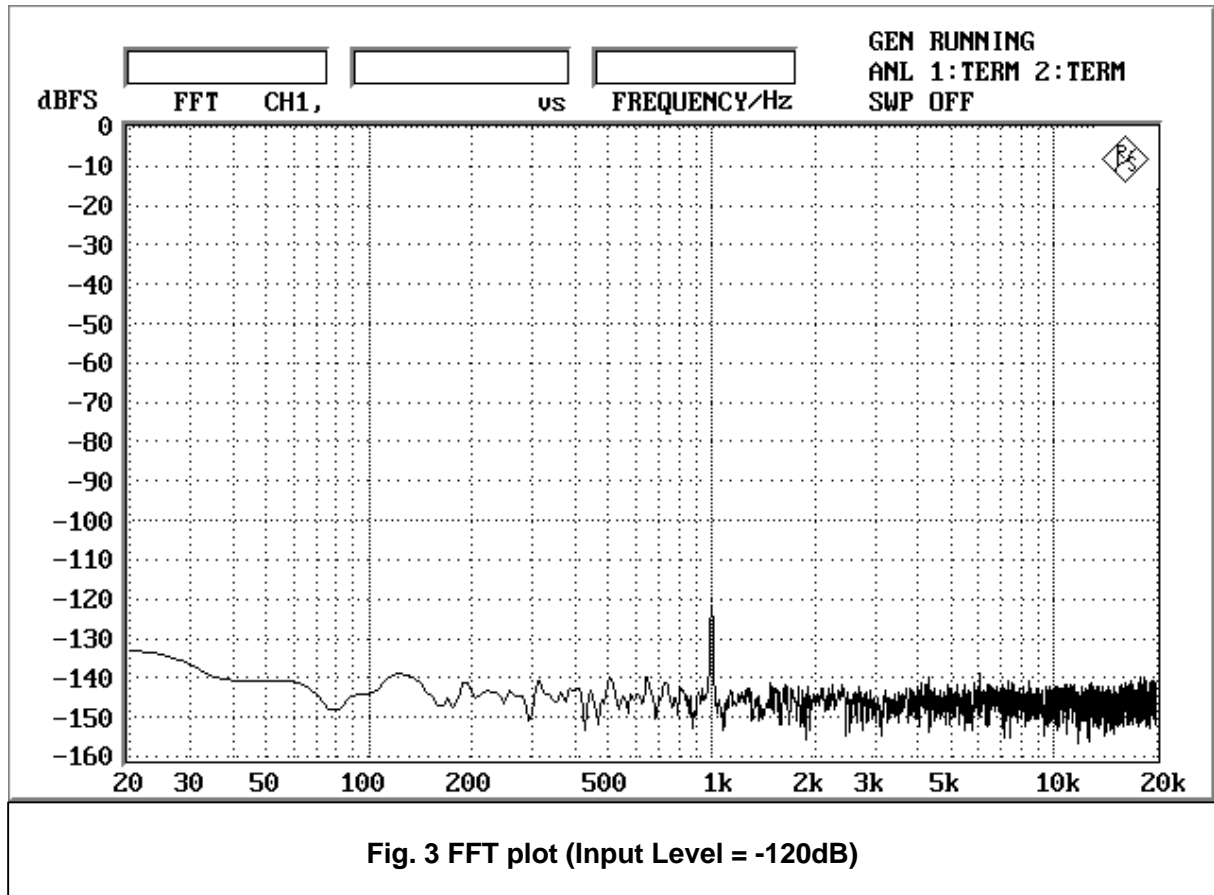

AK5393(fs=48kHz)

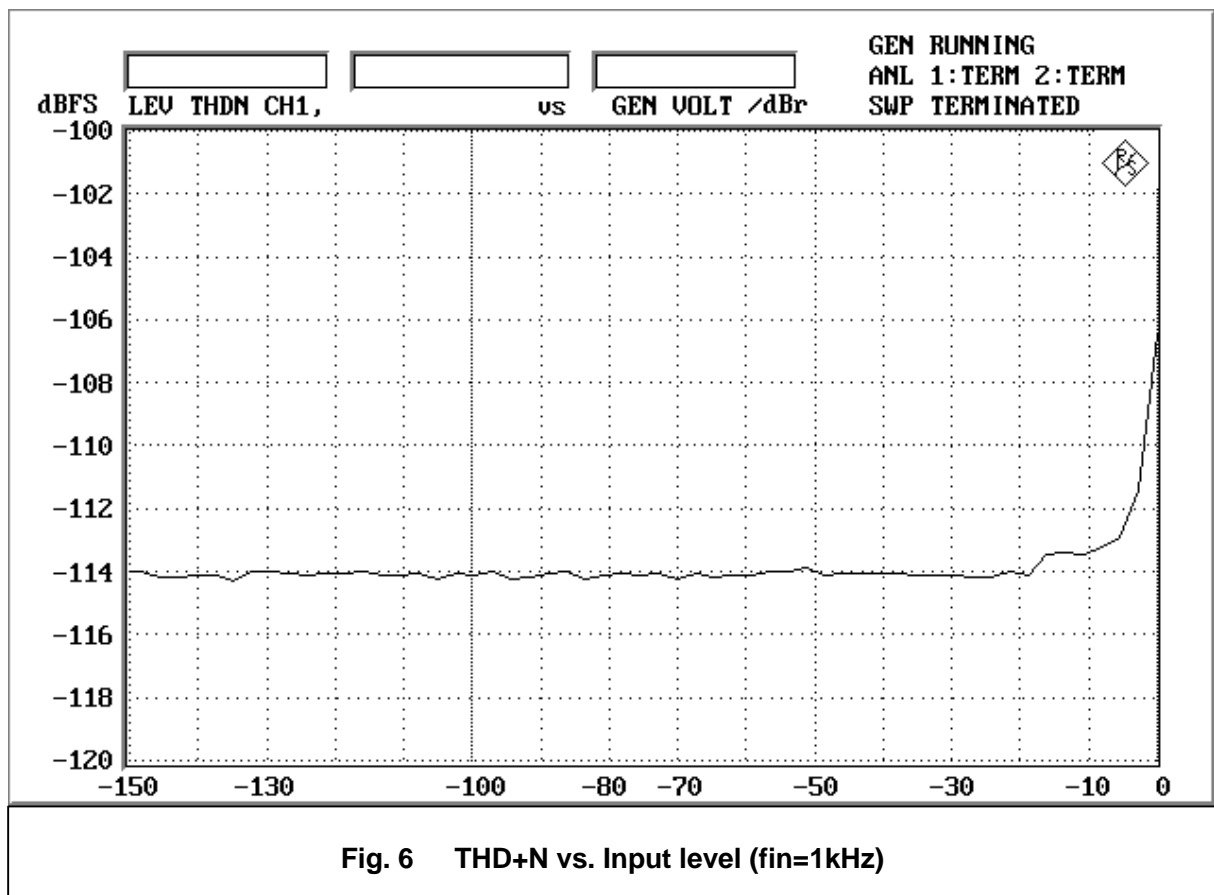
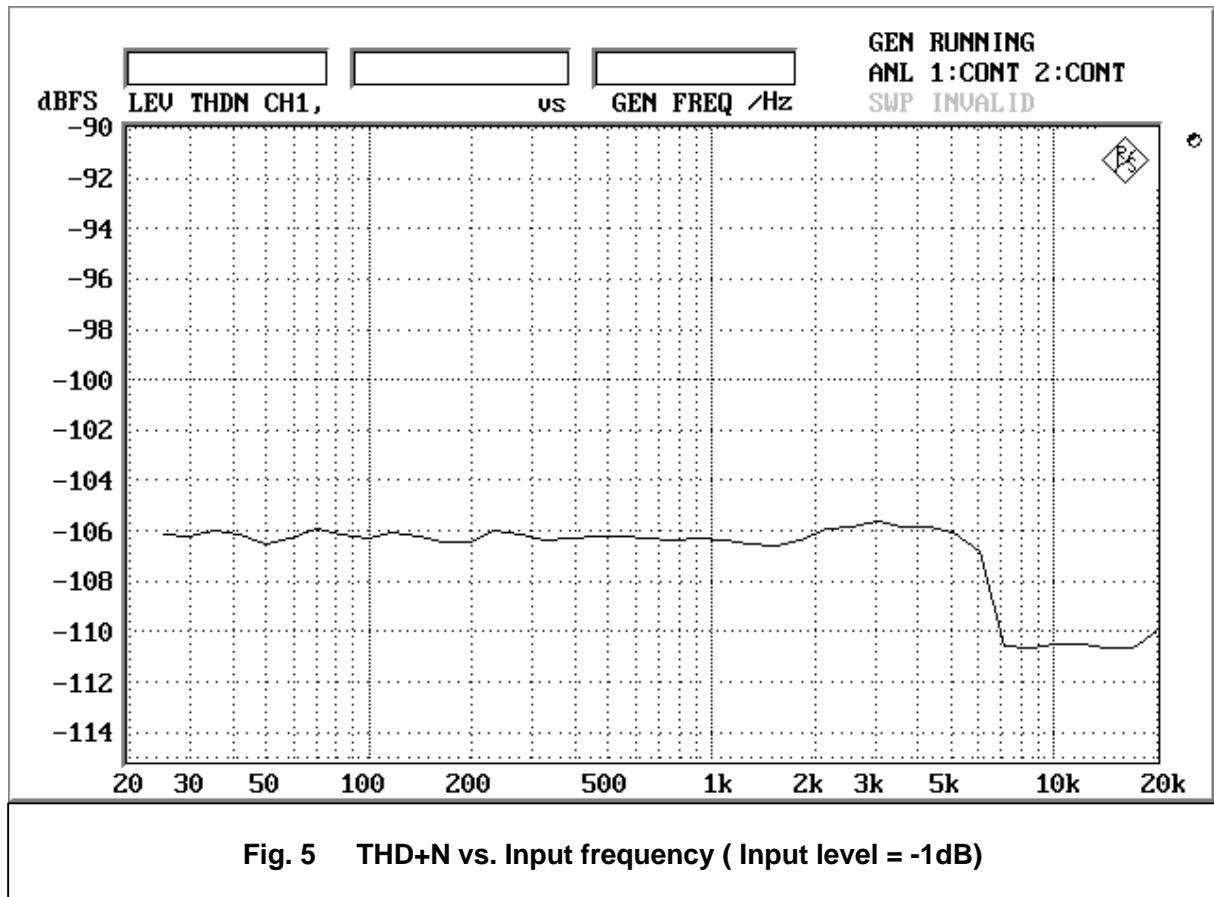

AK5393(fs=48kHz)

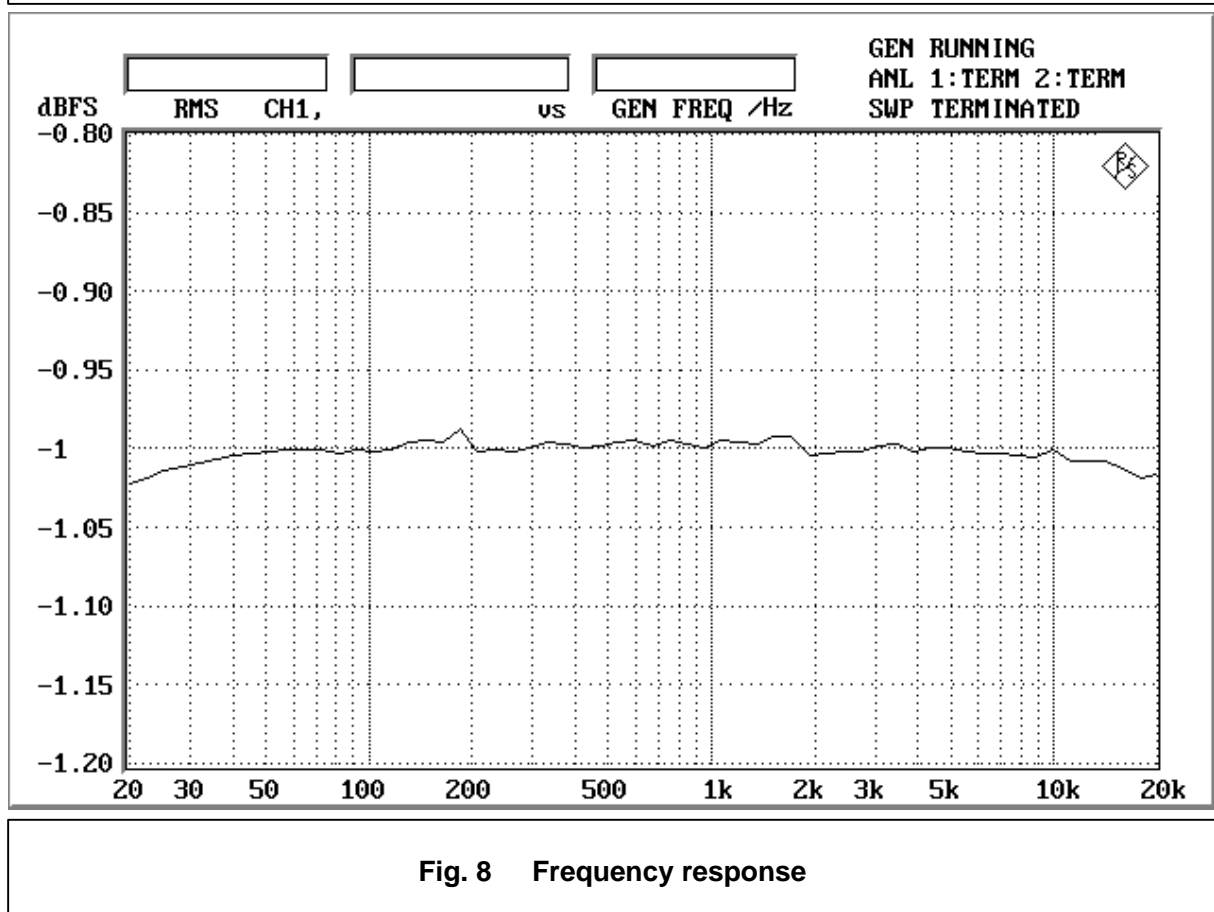
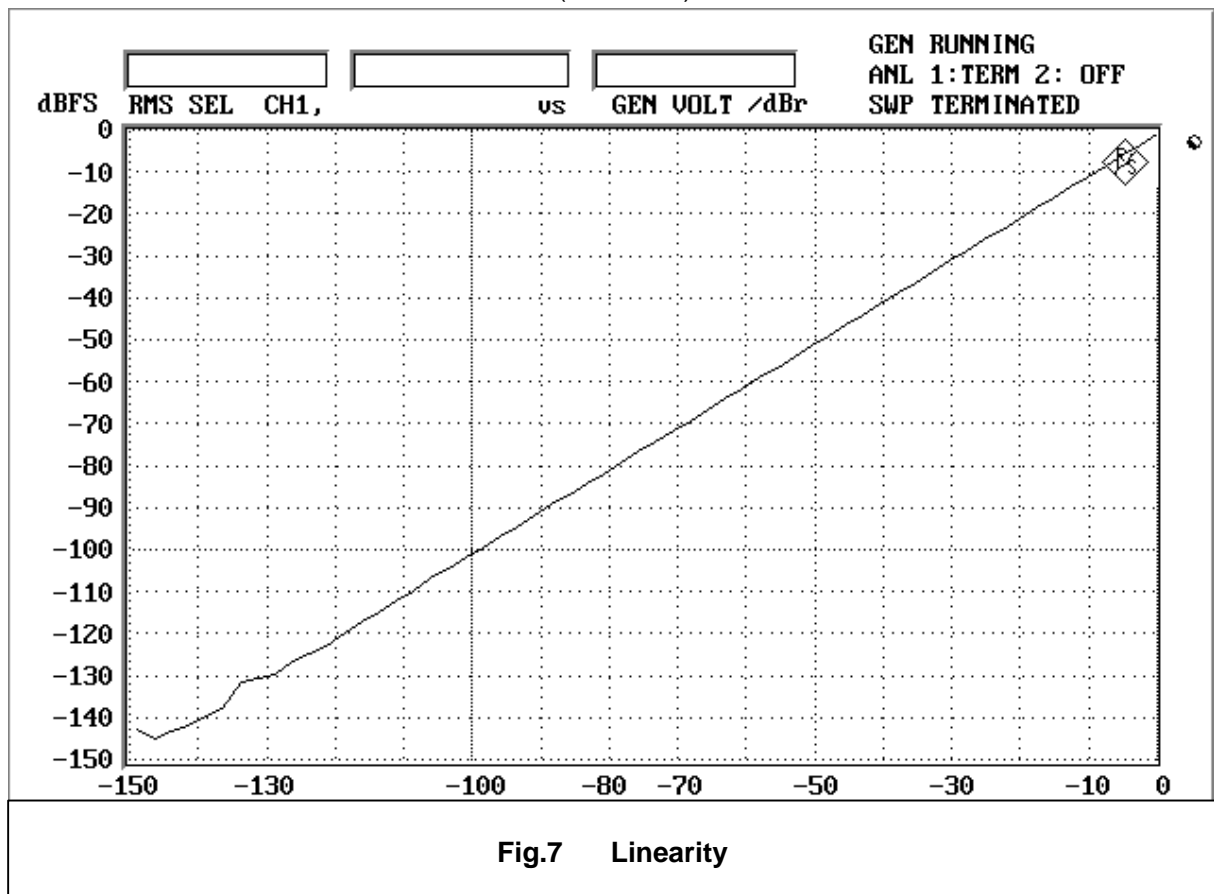

AK5393(fs=48kHz)

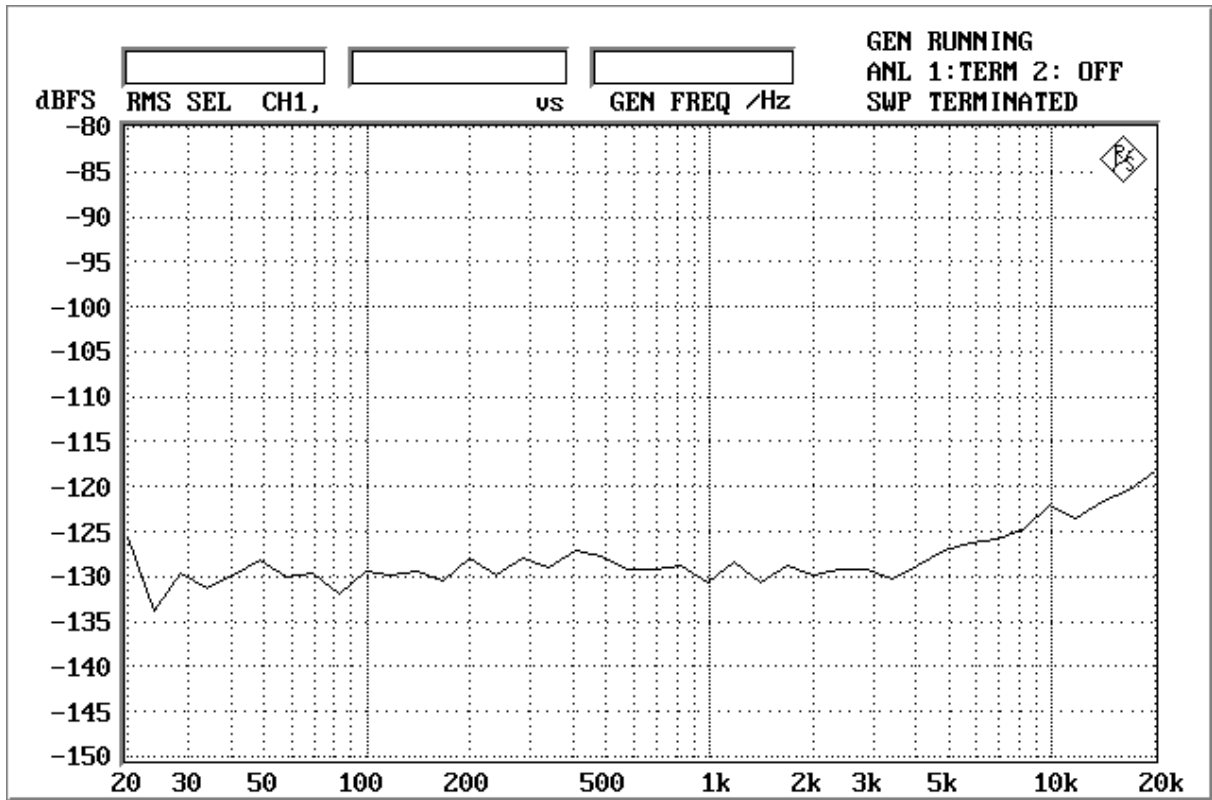
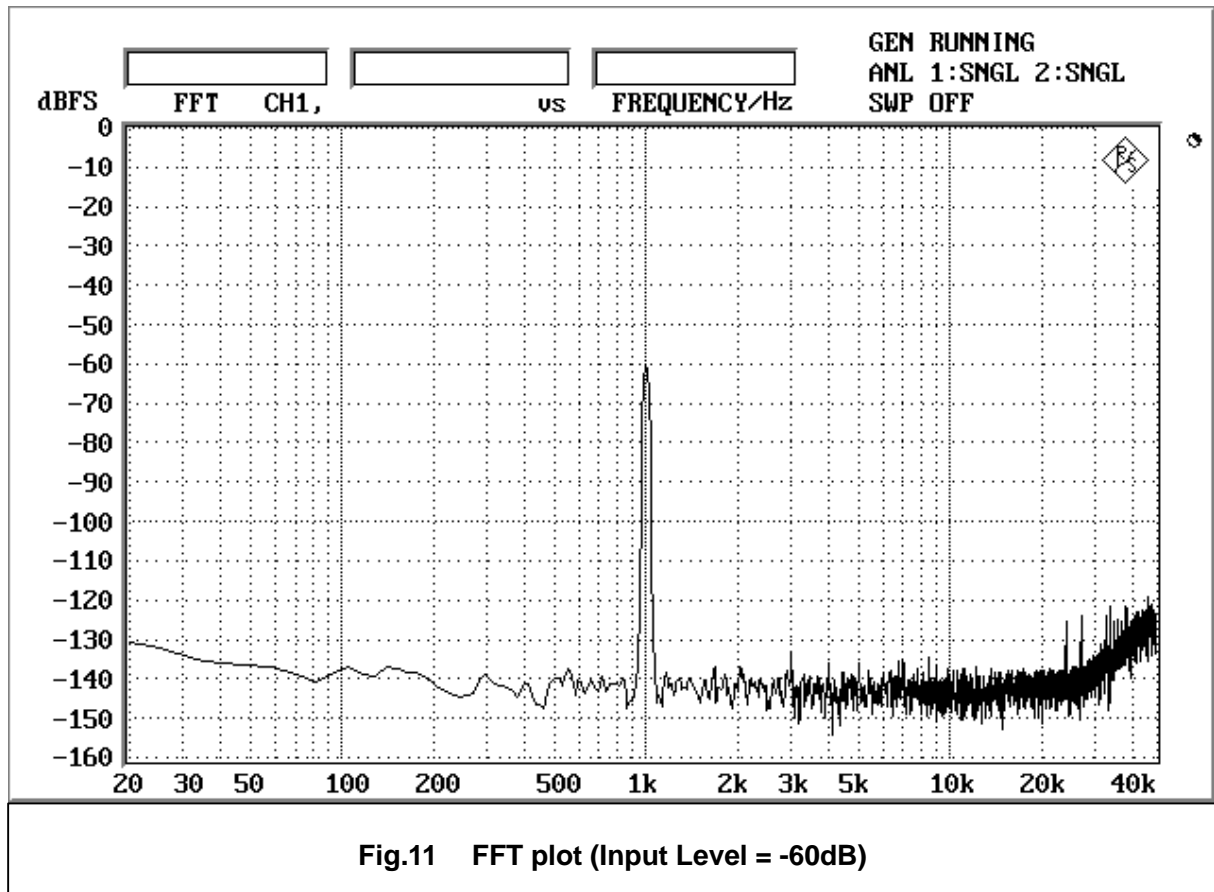
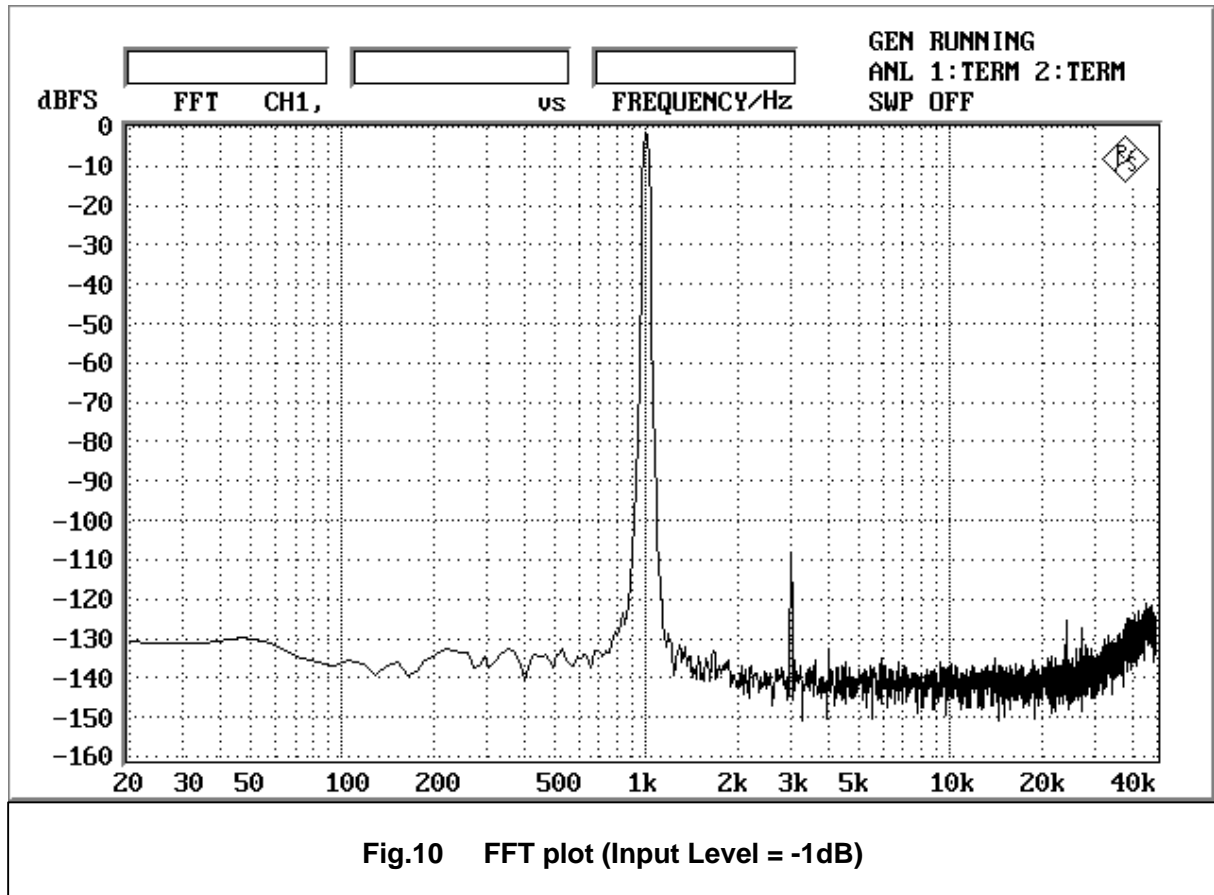
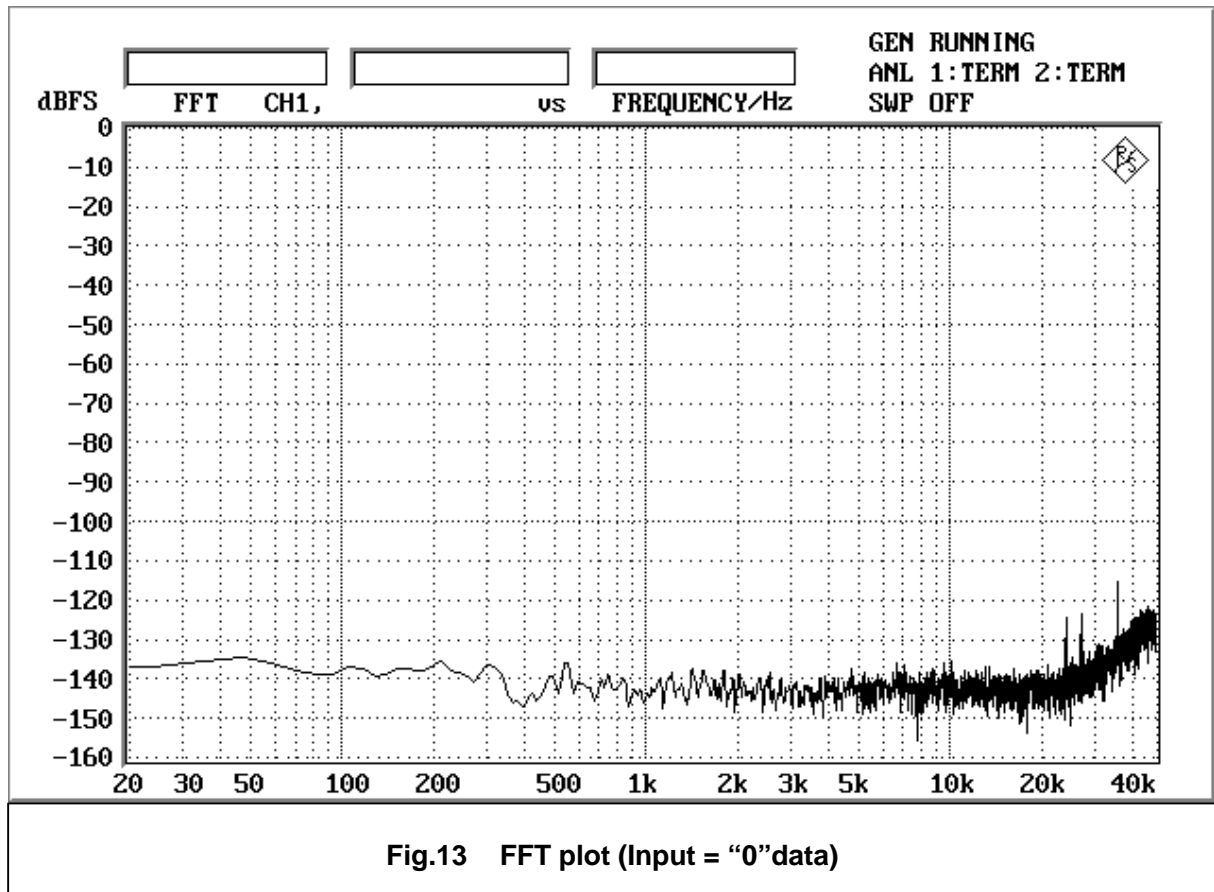
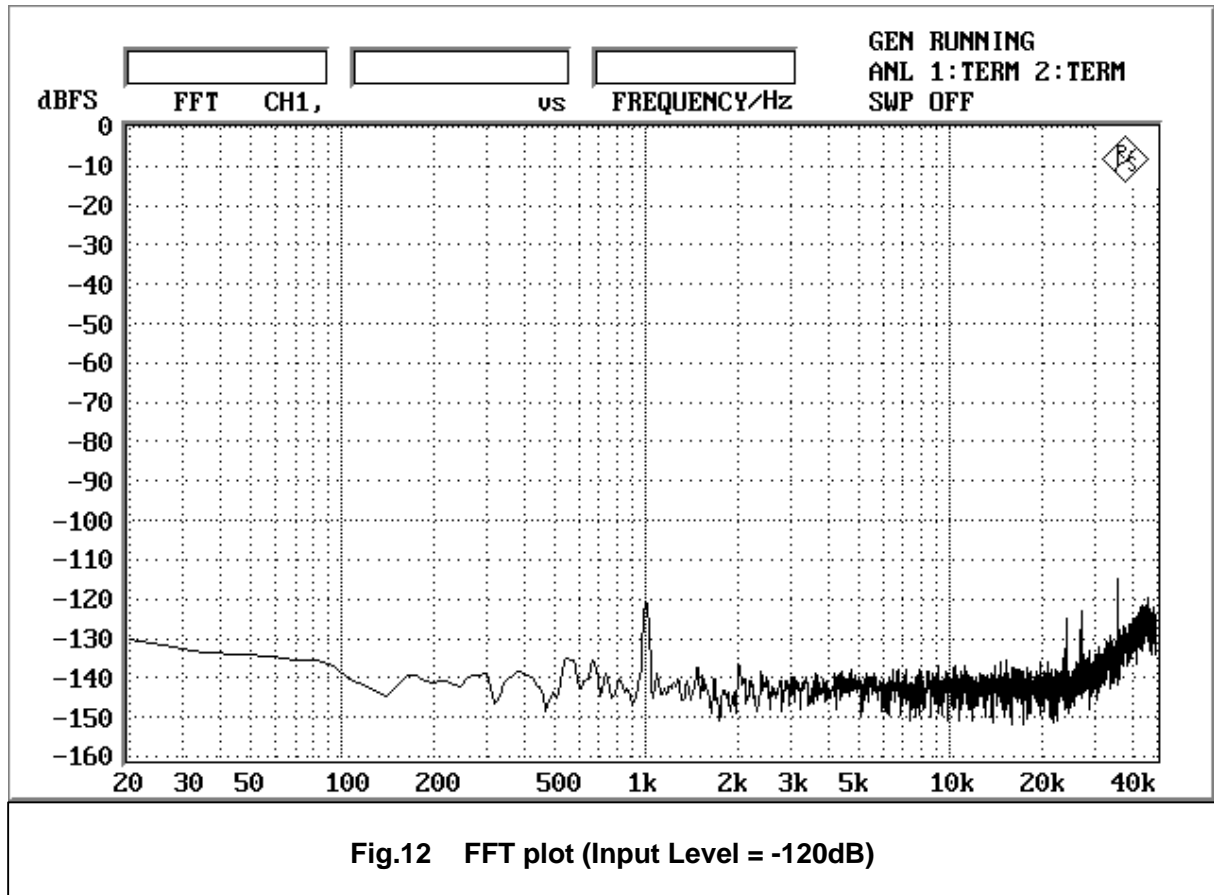
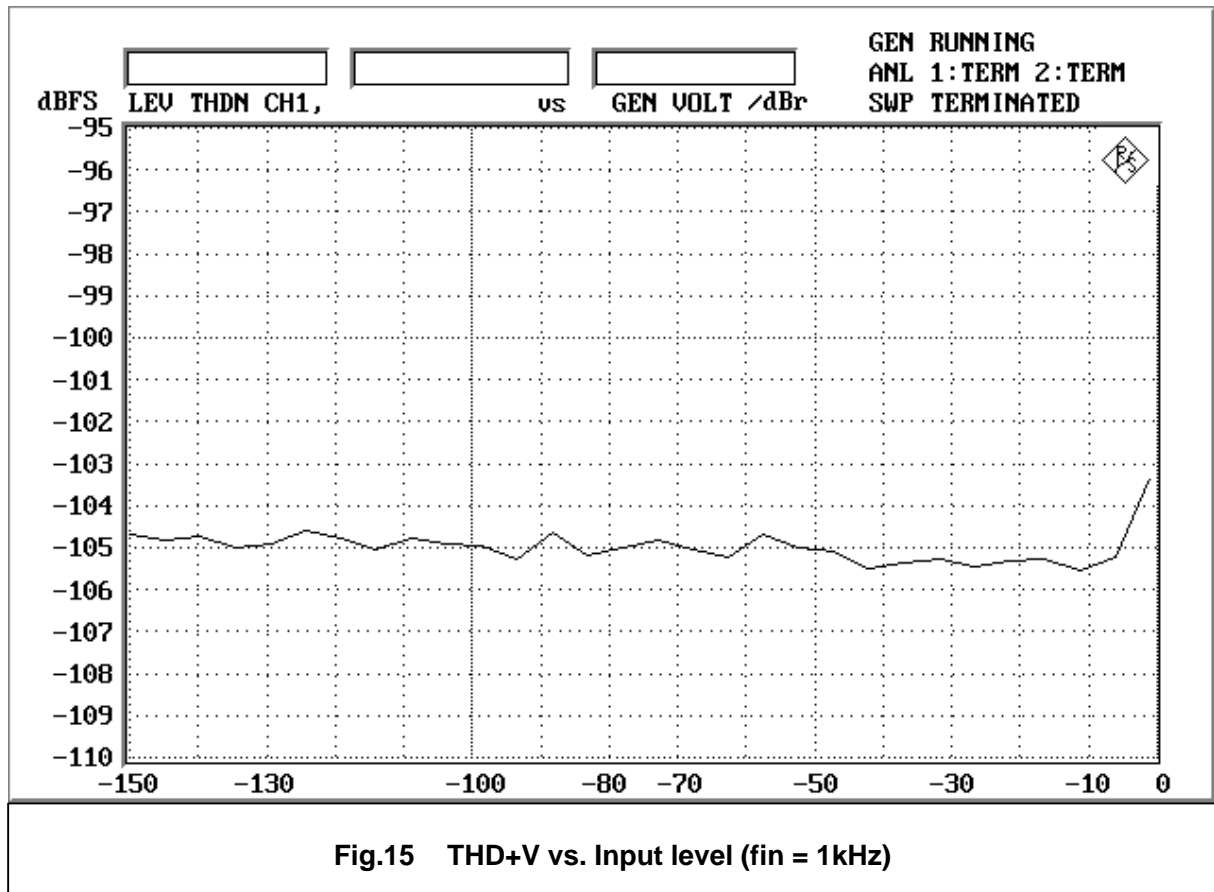
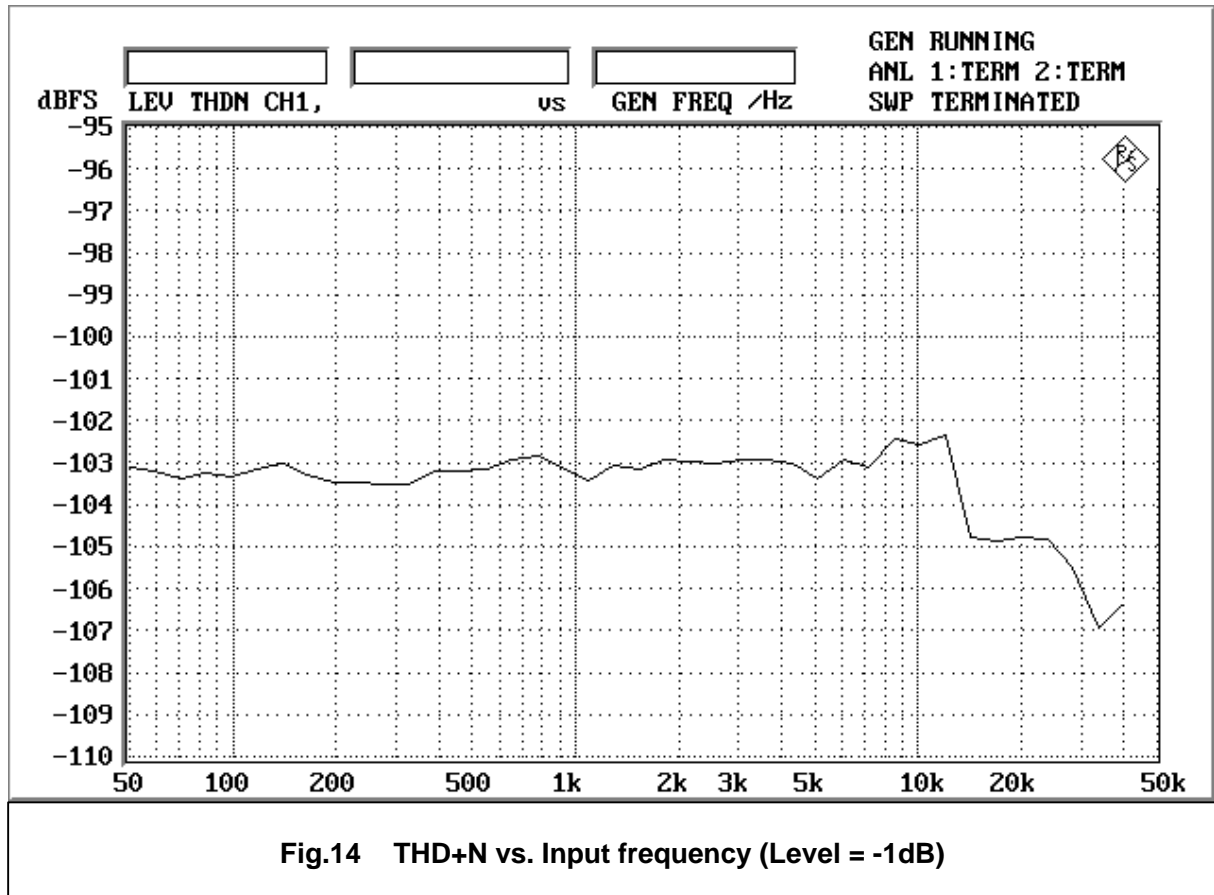

Fig. 9 Crosstalk







AK5393(fs=96kHz)

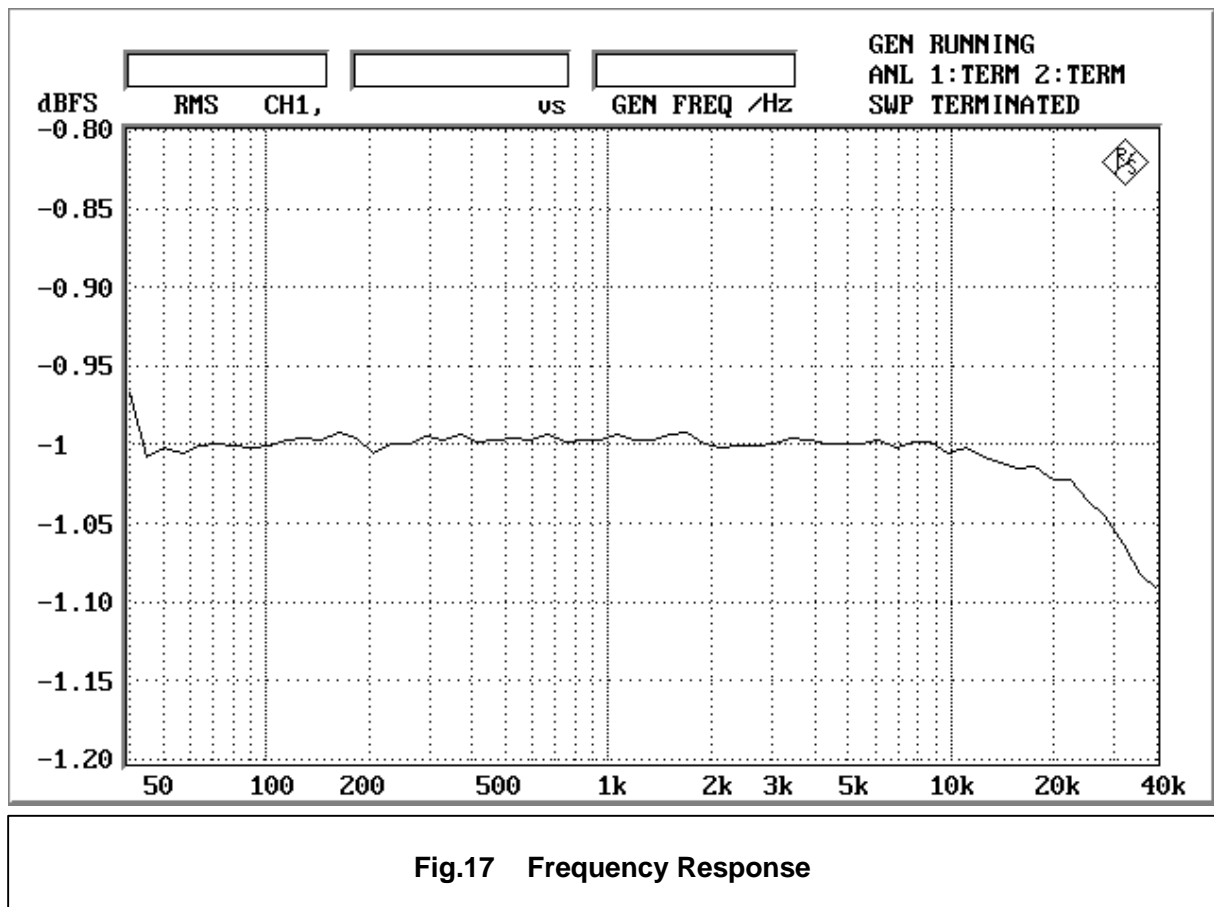
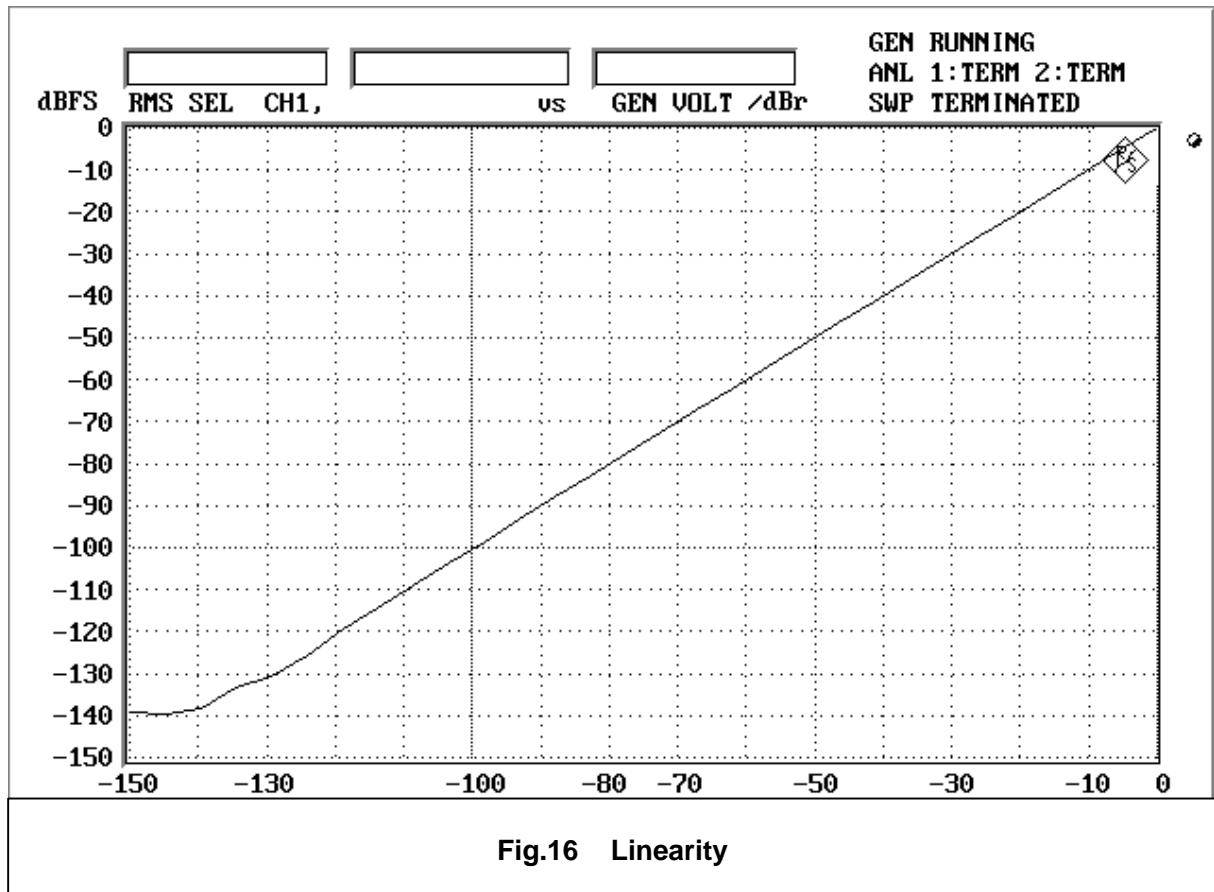

AK5393(fs=96kHz)

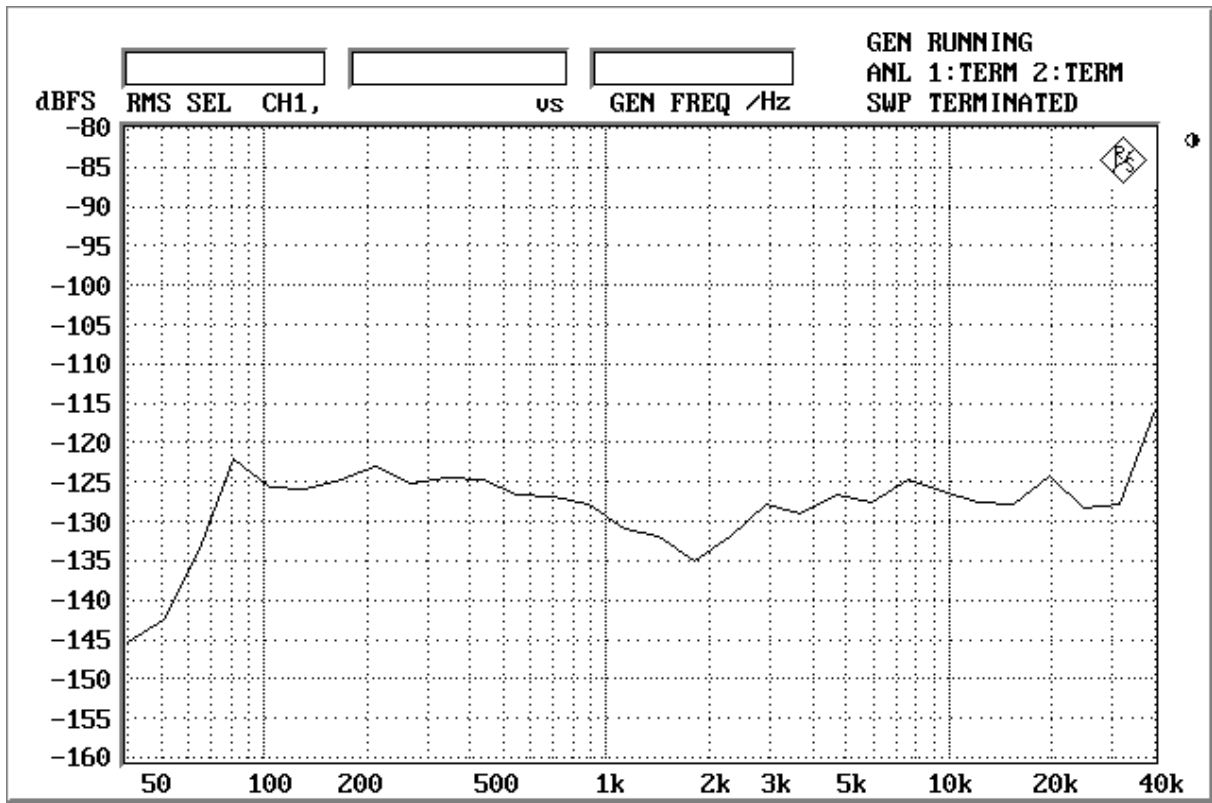
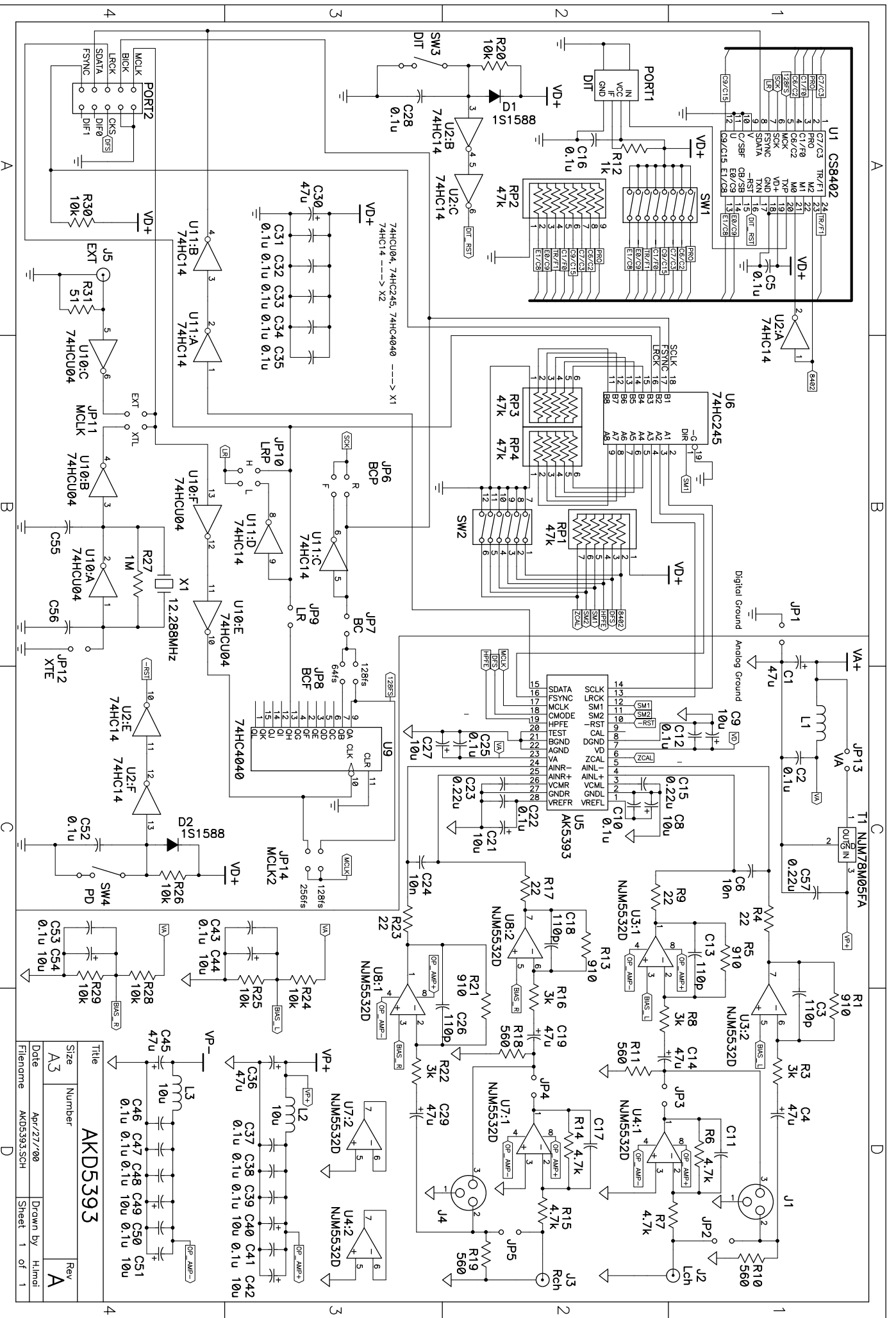
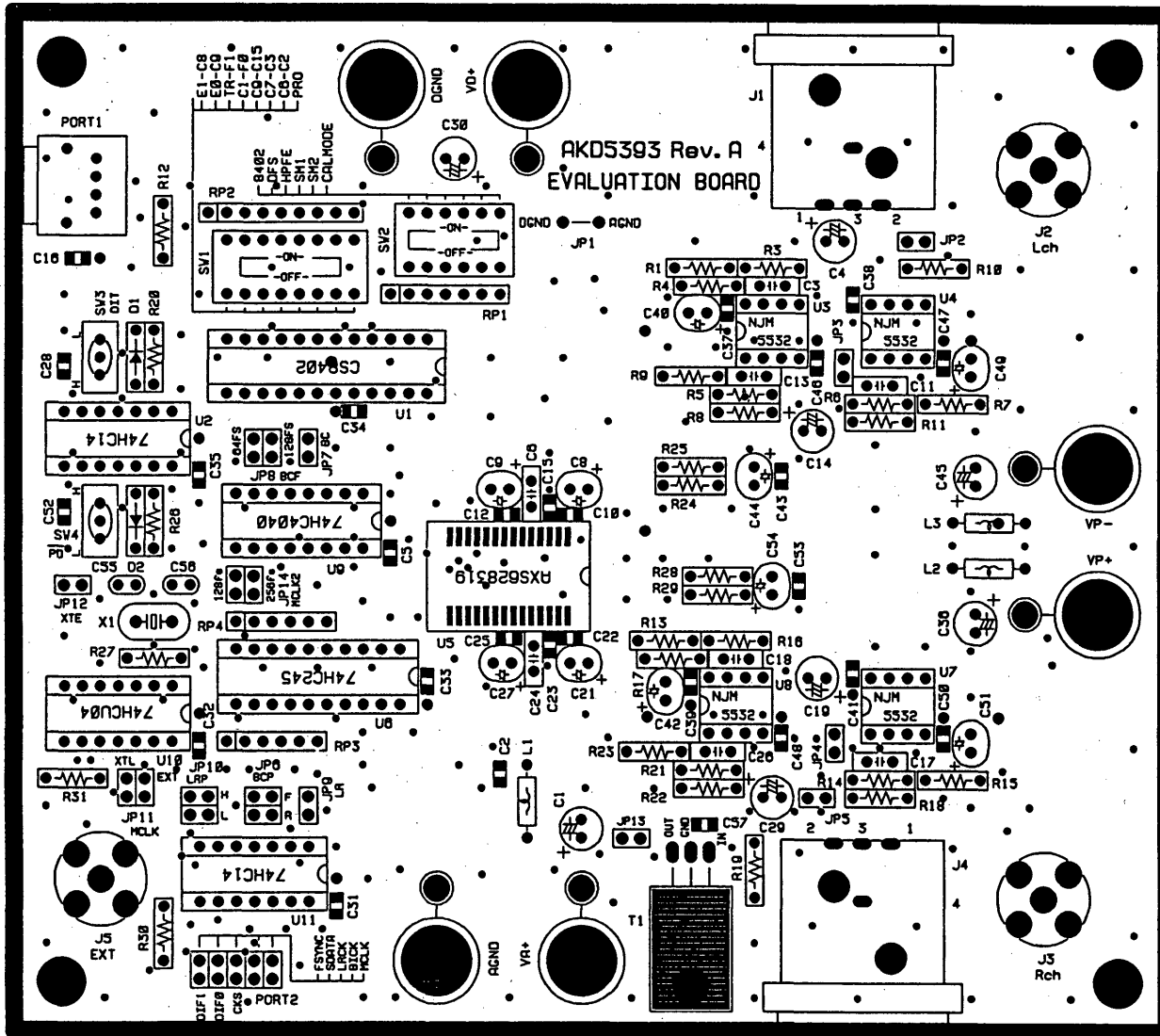

Fig.18 Crosstalk



AKD5393

Title	AKD5393	Rev	A
Size	A3	Number	
Date	Apr/27/00	Drawn by	Himnai
Filename	AKD5393SCH	Sheet	1 of 1



akd5393 rev. a L1 SR
akd5393 rev. a L1 SILK

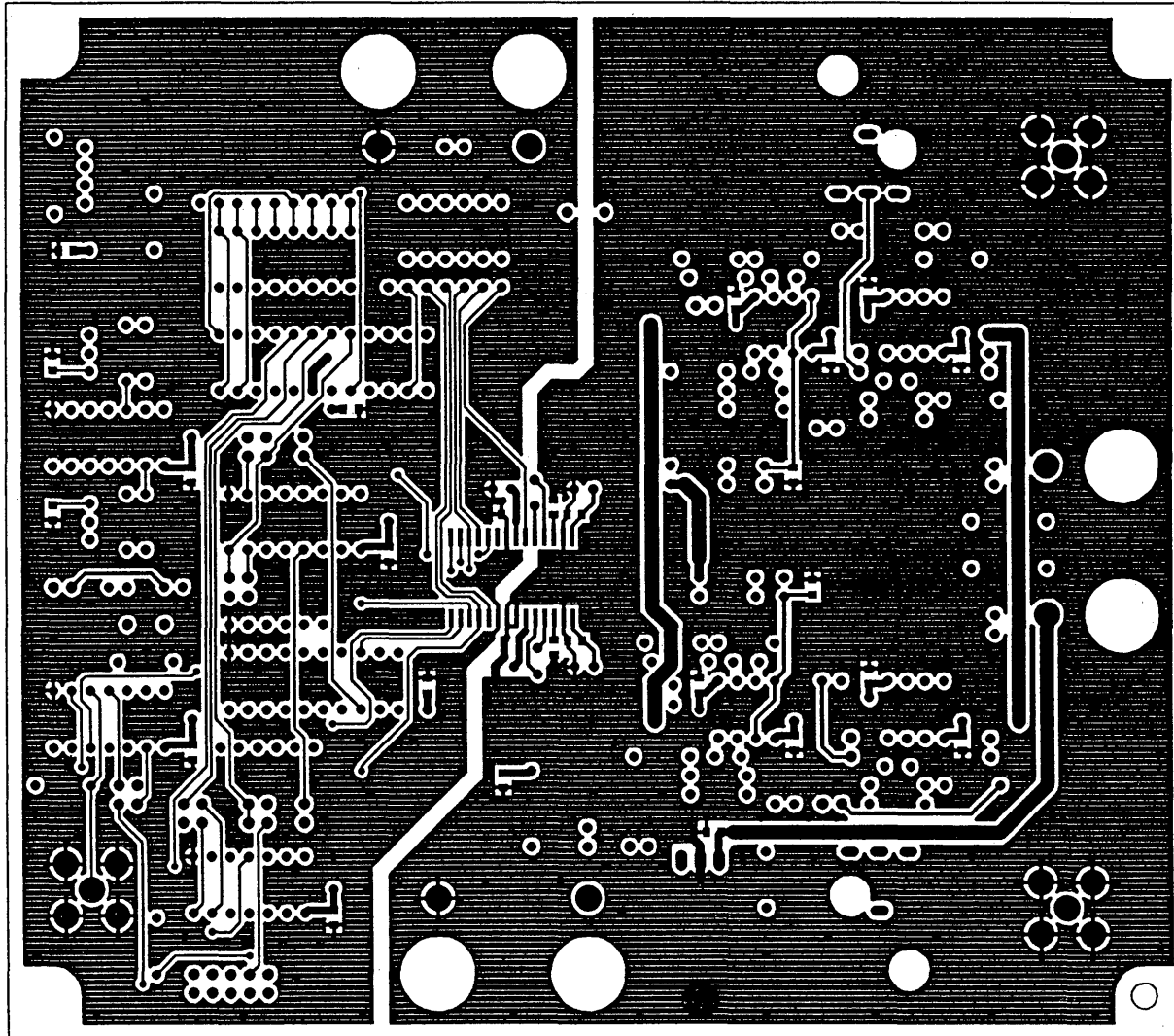

akd5393 rev. a L1

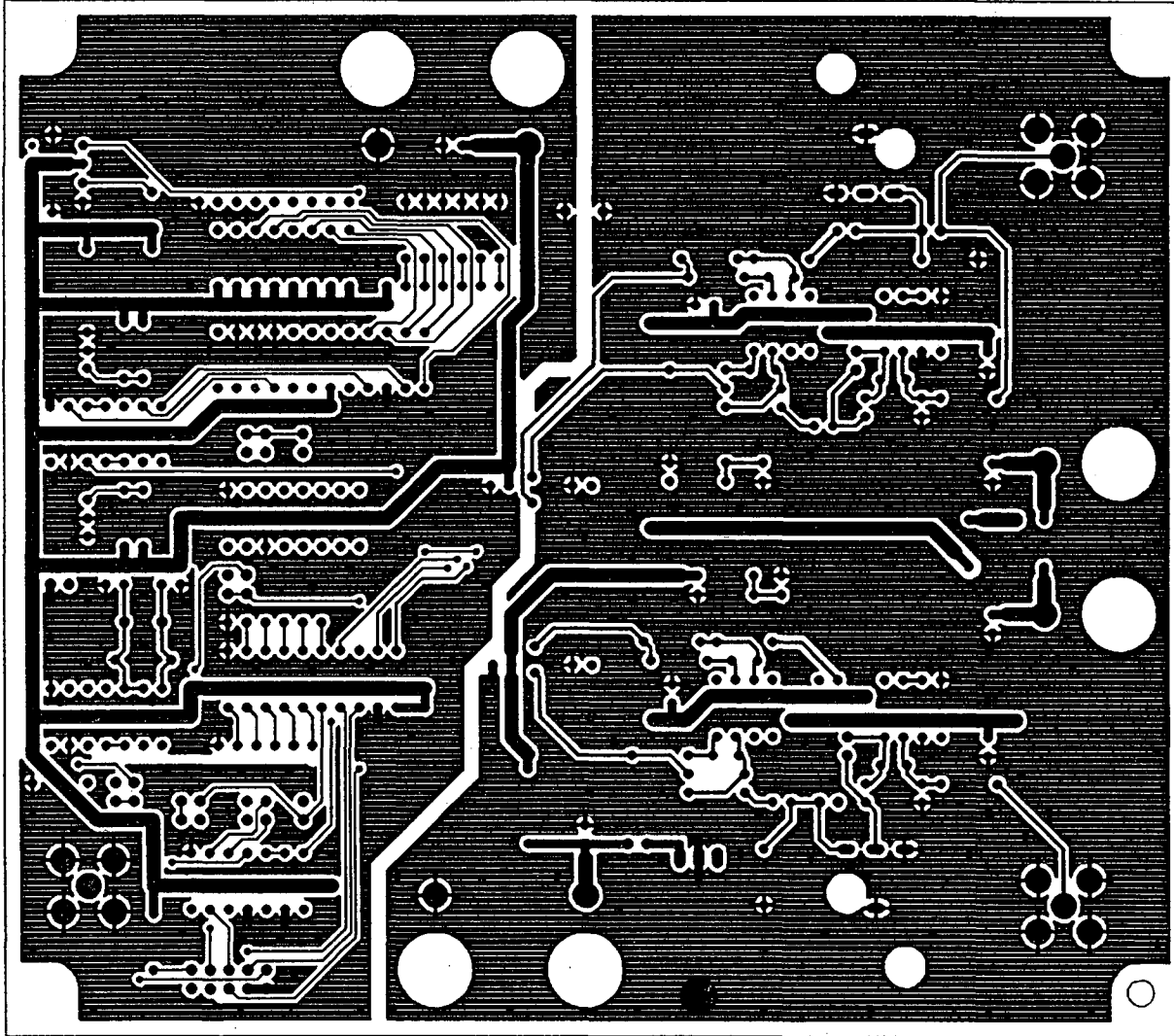

9kq2392 rev. 0 LS