



HIGH SPEED CMOS TIMER

GENERAL DESCRIPTION

The ALD555 timer is a high performance monolithic timing circuit built with advanced silicon gate CMOS technology. It offers the benefits of high input impedance, thereby allowing smaller timing capacitors and longer timing cycle; high speed, with typical cycle time of 500ns; low power dissipation for battery operated environment; reduced supply current spikes, allowing smaller and lower cost decoupling capacitors. It is capable of producing accurate time delays and oscillations in both monostable and astable operation. It operates in the one-shot (monostable) mode or 50% duty cycle free running oscillation mode with a single resistor and one capacitor. The inputs and outputs are fully compatible with CMOS, NMOS or TTL logic.

There are three matched internal resistors (approximately 200KΩ each) that set the threshold and trigger levels at two-thirds and one-third respectively of V+. These levels can be adjusted by using the control terminal (pin 5). When the trigger input is below the trigger level, the output is in the high state and sourcing 2mA. When threshold input is above the threshold level at the same time the trigger input is above the trigger level, the internal flip-flop is reset, the output goes to the low state and sinks up to 10mA. The reset input overrides all other inputs and when it is active (reset voltage less than 1V), the output is in the low state.

FEATURES

- Functional equivalent to NE555 with greatly expanded high and low frequency ranges
- High speed, low power, monolithic CMOS technology
- Low supply current 100µA typical
- Extremely low trigger, threshold and reset currents -- 1pA typical
- High speed operation -- 2MHz oscillation
- Low operating supply voltage 2 to 12V
- Operates in both monostable and astable modes
- Fixed 50% duty cycle or adjustable duty cycle
- CMOS, NMOS and TTL compatible input/output
- High discharge sinking current (80mA)
- Low supply current spikes

ORDERING INFORMATION

Operating Temperature Range *		
-55°C to +125°C	0°C to +70°C	0°C to +70°C
8-Pin CERDIP Package	8-Pin Small Outline Package (SOIC)	8-Pin Plastic Dip Package
ALD555 DA	ALD555 SA	ALD555 PA

* Contact factory for industrial temperature range

APPLICATIONS

- High speed one-shot (monostable) pulse generation
- Precision timing
- Sequential timing
- Long delay timer
- Pulse width and pulse position modulation
- Missing pulse detector
- Frequency divider

PIN CONFIGURATION

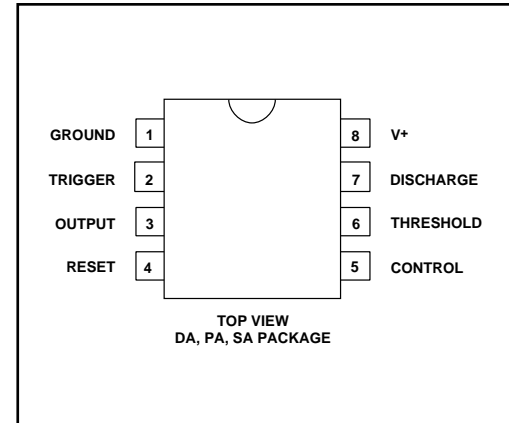

BLOCK DIAGRAM

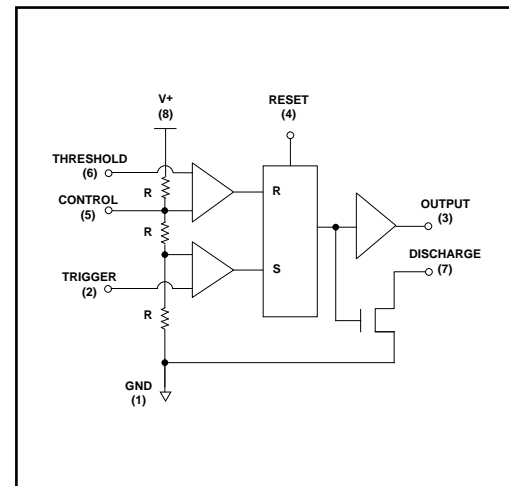

ABSOLUTE MAXIMUM RATINGS

Supply voltage, V+	_____	13.2V
Input voltage range	_____	-0.3V to V+ +0.3V
Power dissipation	_____	600 mW
Operating temperature range	PA,SA package _____	0°C to +70°C
	DA package _____	-55°C to +125°C
Storage temperature range	_____	-65°C to +150°C
Lead temperature, 10 seconds	_____	+260°C

OPERATING ELECTRICAL CHARACTERISTICS

T_A = 25°C V+ = +5V unless otherwise specified

Parameter	Symbol	Min	Typ	Max	Unit	Test Conditions
Supply Voltage	V+	2		12	V	
Supply Current	I _S		100	180	μA	Outputs Unloaded
Timing error / Astable mode Initial Accuracy	t _{err}		1.0	2.2	%	C = 0.1μF
Drift with Temperature ¹	Δt/ΔT		10.0		ppm/°C	R _A = 1KΩ R _B = 1KΩ
Drift with Supply Voltage ¹	Δt/ΔV+		0.1		%/V	
Threshold Voltage	V _{TH}	3.273	3.333	3.393	V	
Trigger Voltage	V _{TRIG}	1.607	1.667	1.737	V	
Trigger Current ²	I _{TRIG}		.001	0.2	nA	
Reset Voltage	V _{RST}	0.4	0.7	1.0	V	
Reset Current ²	I _{RST}		.001	0.2	nA	
Threshold Current ²	I _{TH}		.001	0.2	nA	
Control Voltage Level	V _{CONT}	3.273	3.333	3.393	V	
Output Voltage Drop (Low)	V _{OL}		0.2	0.4	V	I _{SINK} = 10mA
Output Voltage Drop (High)	V _{OH}			4.2	V	I _{SOURCE} = -2mA
Rise Time of Output ¹	t _r		15	30	ns	R _L = 10MΩ
Fall Time of Output ¹	t _f		10	20	ns	C _L = 10pF
Discharge Transistor Leakage Current	I _{DL}		.01		nA	
Discharge Voltage Drop	V _{DISC}		0.5 0.2	1.0 0.4	V V	I _{DISCHARGE} = 80mA I _{DISCHARGE} = 30mA
Maximum Frequency Astable Mode	f _{MAX}	1.4	2		MHz	R _A = 470Ω R _B = 200Ω C _T = 200pF

Notes: ¹ Sample tested parameters.

² Consists of junction leakage currents with strong temperature dependence.

TYPICAL PERFORMANCE CHARACTERISTICS

DISCHARGE OUTPUT SINK CURRENT AS A FUNCTION OF DISCHARGE LOW VOLTAGE

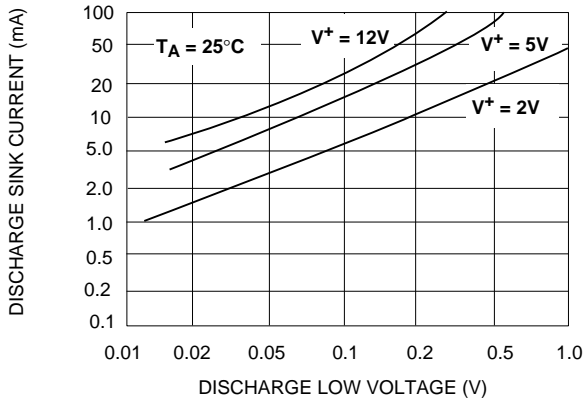

MINIMUM PULSE WIDTH REQUIRED FOR TRIGGERING

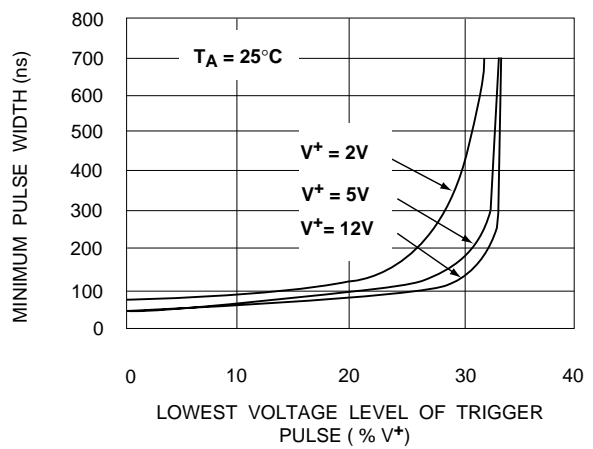

FREE RUNNING FREQUENCY AS A FUNCTION OF R_A , R_B AND C

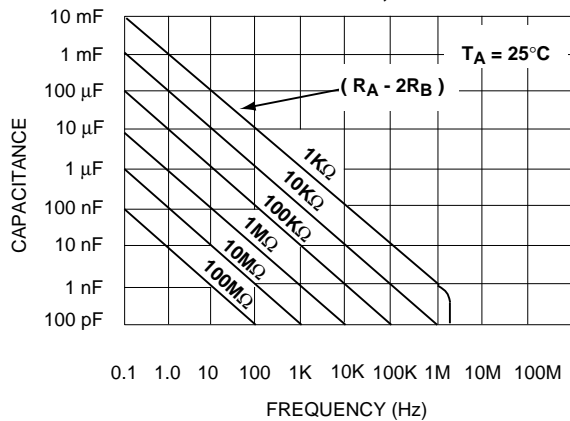

FREQUENCY CHANGE IN THE ASTABLE MODE AS A FUNCTION OF SUPPLY VOLTAGE

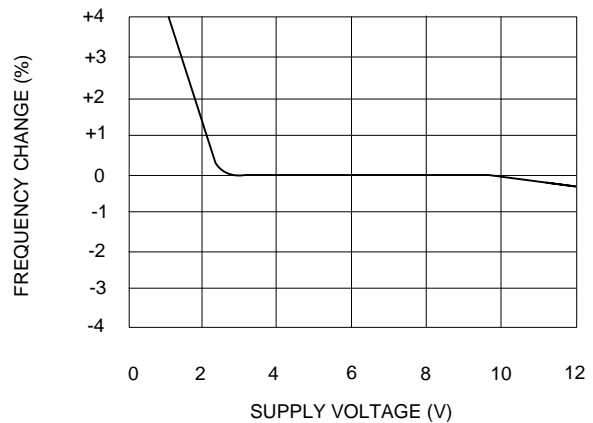

TIME DELAY IN THE MONOSTABLE MODE AS A FUNCTION OF R_A AND C

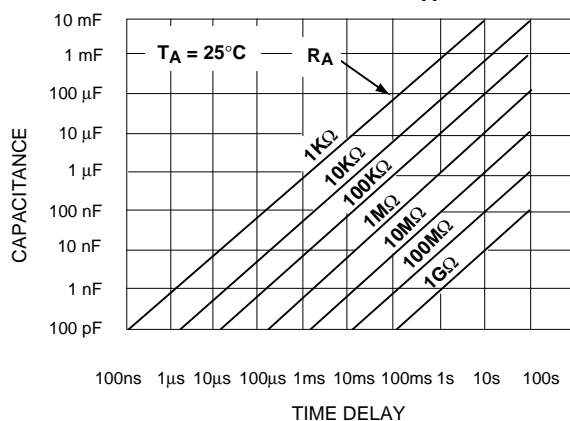

SUPPLY CURRENT AS A FUNCTION OF SUPPLY VOLTAGE

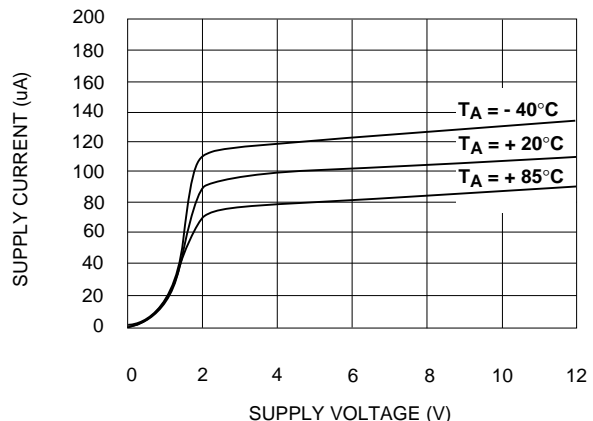

TYPICAL PERFORMANCE CHARACTERISTICS

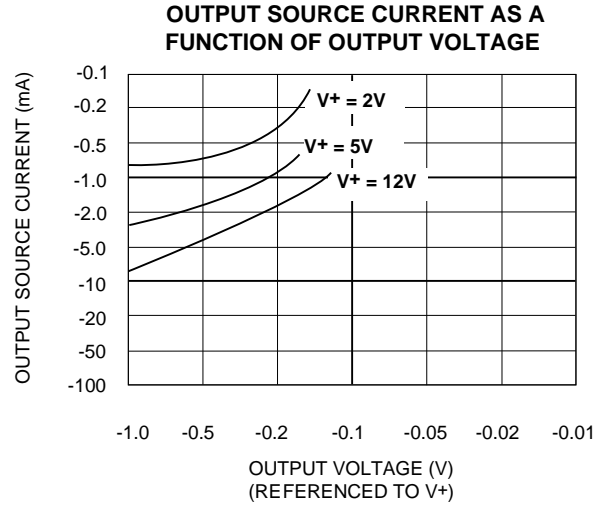
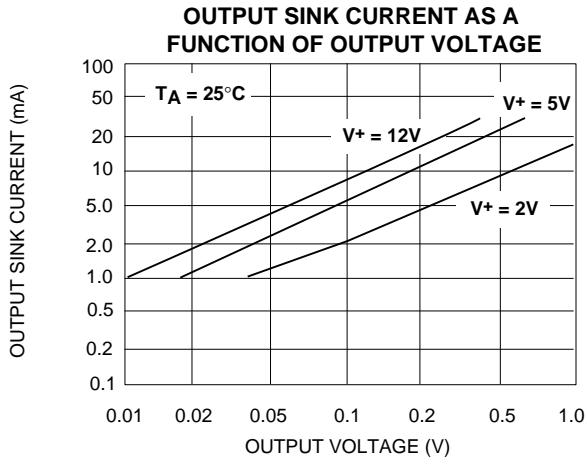

TYPICAL APPLICATIONS

ASTABLE MODE OPERATION 50% DUTY CYCLE

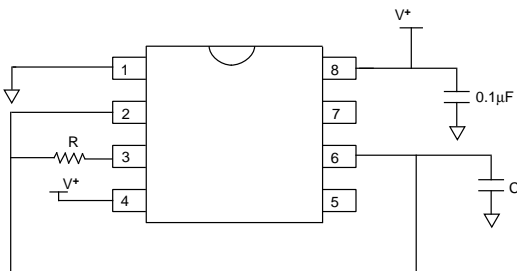

$$\text{Frequency } f = 1 / (1.4 RC)$$

ASTABLE MODE OPERATION (FREE RUNNING OSCILLATOR)

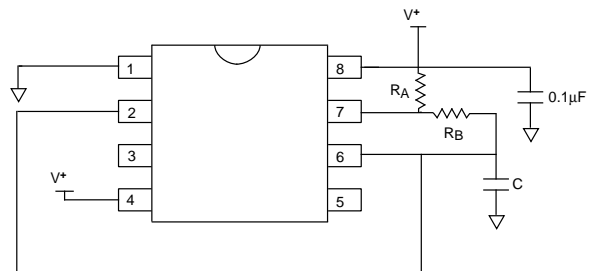

$$\text{Frequency } f = 1.46 / (RA + 2RB)C$$

$$\text{Duty Cycle DC} = RB / (RA + 2RB)$$

MONOSTABLE MODE OPERATION (ONE SHOT PULSE)

Pulse Delay $t_d = 1.1 RC$

