



We make the parts that set creative people free™

General Description

The AL1401A OptoGen interface is designed to accept four stereo pairs of audio data and produce the data stream appropriate for the Alesis ADAT® optical format, U.S. patent number 5,297,181.

Use of this product requires a license agreement between manufacturer and Alesis Studio Electronics. Details and agreement information are available upon request from Alesis Semiconductor or Alesis Studio Electronics.

Features

- ❑ Compatible with ADAT® Type I and II formats
- ❑ 4 stereo pairs as inputs using standard DAC formats
- ❑ 4 user bit inputs to transmit time-code, MIDI data, etc.
- ❑ Internal PLL generates required clocks from Word Clock.

Applications

- ❑ Transmit information to ADAT® compatible devices

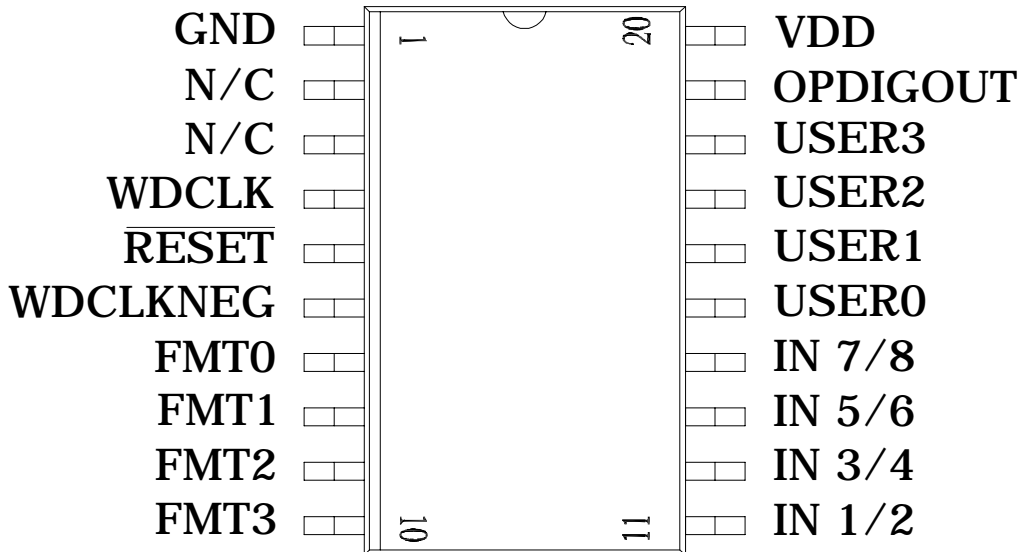

Figure A. 24 pin SOIC

OptoGen AL1401A Converter

Table 1. Electrical Characteristics and Operating Conditions

Symbol	Description	Min	Typ	Max	Units
Electrical Characteristics and Operating Conditions					
V _{DD}	Supply Voltage	4.5	5.0	5.5	V
I _{DD}	Supply Current	-	1.5	-	mA
GND	Ground	-	0.0	-	V
F _s	Sample rate	30	48	55	kHz
Temp	Temperature	0	25	70	°C

Outputs (OPDIGOUT)

V _{OH}	Logical "1" output voltage	0.9 V _{DD}	-	-	V _{DD}
V _{OL}	Logical "0" output voltage	-	-	0.1 V _{DD}	V _{DD}
I _{OH}	Logical "1" output current	-	-	-8	mA
I _{OL}	Logical "0" output current	-	-	8	mA

Inputs (WDCLK, WDCLKNEG, FMT, IN, USER, RESET)

V _{IH}	Logical "1" input voltage	0.75 V _{DD}	-	-	V _{DD}
V _{IL}	Logical "0" input voltage	-	-	0.25 V _{DD}	V _{DD}
I _{IH}	Logical "1" input current	-	-	1	uA
I _{IL}	Logical "0" input current	-	-	1	uA
C _{IN}	Logic Input Capacitance	-	5	-	pF

Table 2. Pin Descriptions

Pin #	Name	Pin Type	Description
1	GND	Power	Ground pin
2	N/C	-	No connection
3	N/C	-	No connection
4	WDCLK	Input	Word clock. Equal to sample frequency (Fs)
5	RESET	Input	Active low reset
6	WDCLKNEG	Input	Sets phase of word clock
7	FMT0	Input	Format0. Sets data format
8	FMT1	Input	Format1. Sets data format
9	FMT2	Input	Format2. Sets data format
10	FMT3	Input	Format3. Sets data format
11	IN 1/2	Input	Channels 1 and 2 data input
12	IN 3/4	Input	Channels 3 and 4 data input
13	IN 5/6	Input	Channels 5 and 6 data input
14	IN 7/8	Input	Channels 7 and 8 data input
15	USER0	Input	User 0 data bit input. Used to transmit timecode.
16	USER1	Input	User 1 data bit input. Used to transmit MIDI data.
17	USER2	Input	User 2 data bit input. Reserved, tie low.
18	USER3	Input	User 3 data bit input. Reserved, tie low.
19	OPDIGOUT	Output	Output to optical driver
20	V _{DD}	Power	+5V power pin

Table 3. Formats

Format0	Format1	Format2	Format3	Mode
0	0	0	0	16-bit right justified
1	0	0	0	18-bit right justified
0	1	0	0	20-bit right justified
1	1	0	0	22-bit right justified
0	0	1	0	16-bit left justified
1	0	1	0	18-bit left justified
0	1	1	0	20-bit left justified
1	1	1	0	22-bit left justified
0	0	0	1	Reserved
1	0	0	1	Reserved
0	1	0	1	Reserved
1	1	0	1	Reserved
0	0	1	1	24-bit right justified
1	0	1	1	24-bit left justified
0	1	1	1	Reserved
1	1	1	1	Mute

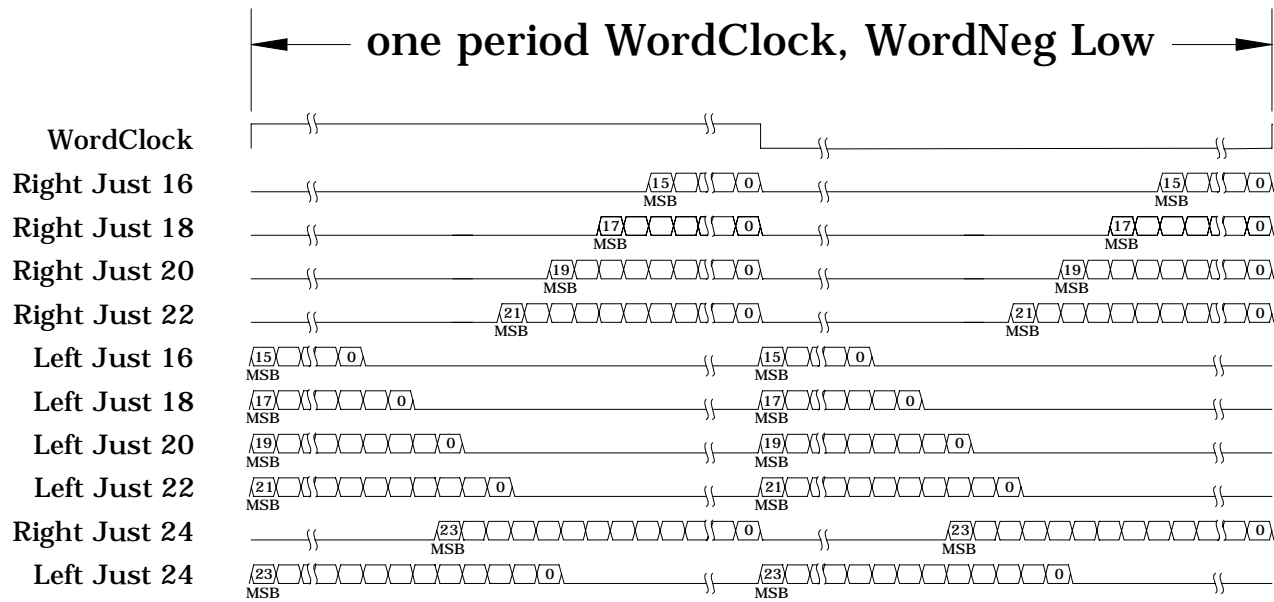

Figure B. Format Timing

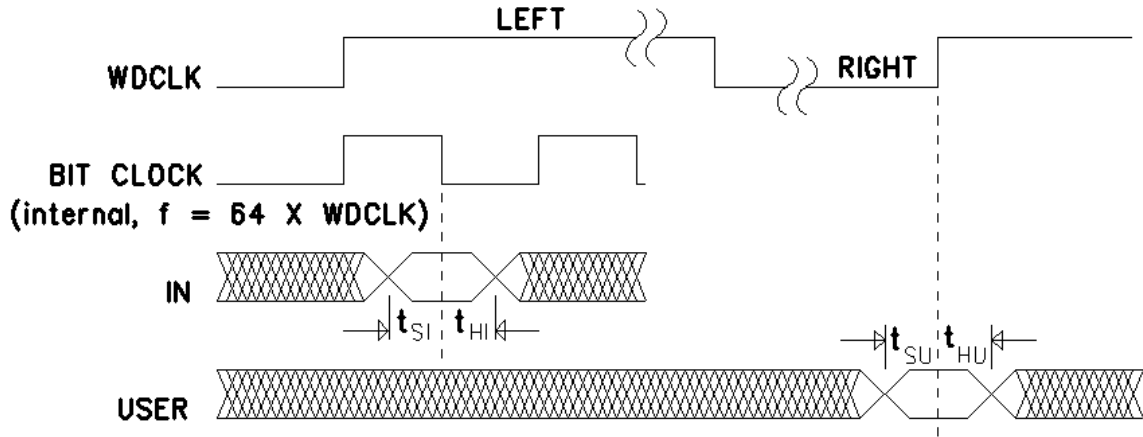

Figure C/Table 4. Input Timing

Symbol	Description	Min	Typ	Max	Units
t_{SI}	Setup of IN relative to center of bit period	-	10	30	nsec
t_{HI}	Hold of IN relative to center of bit period	-	10	30	nsec
t_{SU}	Setup of USER relative to end of right channel WDCLK time	-	-	100	nsec
t_{HU}	Hold of USER relative to end of right channel WDCLK time	-	-	100	nsec

(Above specifications hold after 2000 WDCLK cycles)



Use

The AL1401A OptoGen interface has been designed for ease of use and flexibility in systems designed to interface to the ADAT® protocol. It supports both left and right justified 16, 18, 20, 22 and 24-bit data formats for ease of integration into existing devices as well as new devices. These formats allow it to operate in parallel with many standard DACs.

The designer uses the WDCLKNEG, Format0, Format1, Format2 and Format3 pins to select the desired format.

If WDCLKNEG is high, the falling edge of WDCLK signals the start of a new sample period. If low, the rising

edge of WDCLK signals the start of a new sample period. In both cases, the first sample data sent is the odd numbered (left) channel. The second is the even numbered (right) channel. The format pins are summarized in Table 3. The AL1401A provides support for both the ADAT® Type I format (16-bit) and the ADAT® Type II format (20-bit).

USER0 is used to transmit the ADAT format 32-bit timecode. USER1 is used to transmit MIDI data. USER2 and USER3 are reserved and should be tied low. User bits are sampled at the WDCLK edge that indicates the end of right channel data.

Mechanical Specification

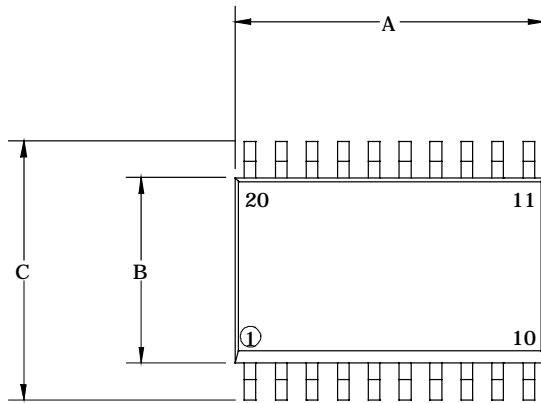

Table 5. Package Dimensions

	Dimensions (Typical)	
	Inches	Millimeters
A	.504"	12.80
B	.295"	7.50
C	.406"	10.30
D	.100"	2.50
E	.008"	0.20
F	.025"	0.64
G	.050"	1.27
H	.017"	0.42
J	.011"	0.27
K	.352"	8.94
L	.033"	0.83

Notes:

- 1) Dimension "A" does not include mold flash, protrusions or gate burrs.

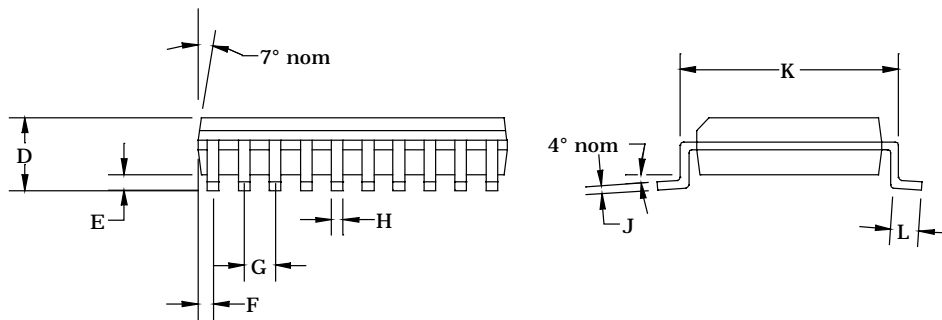
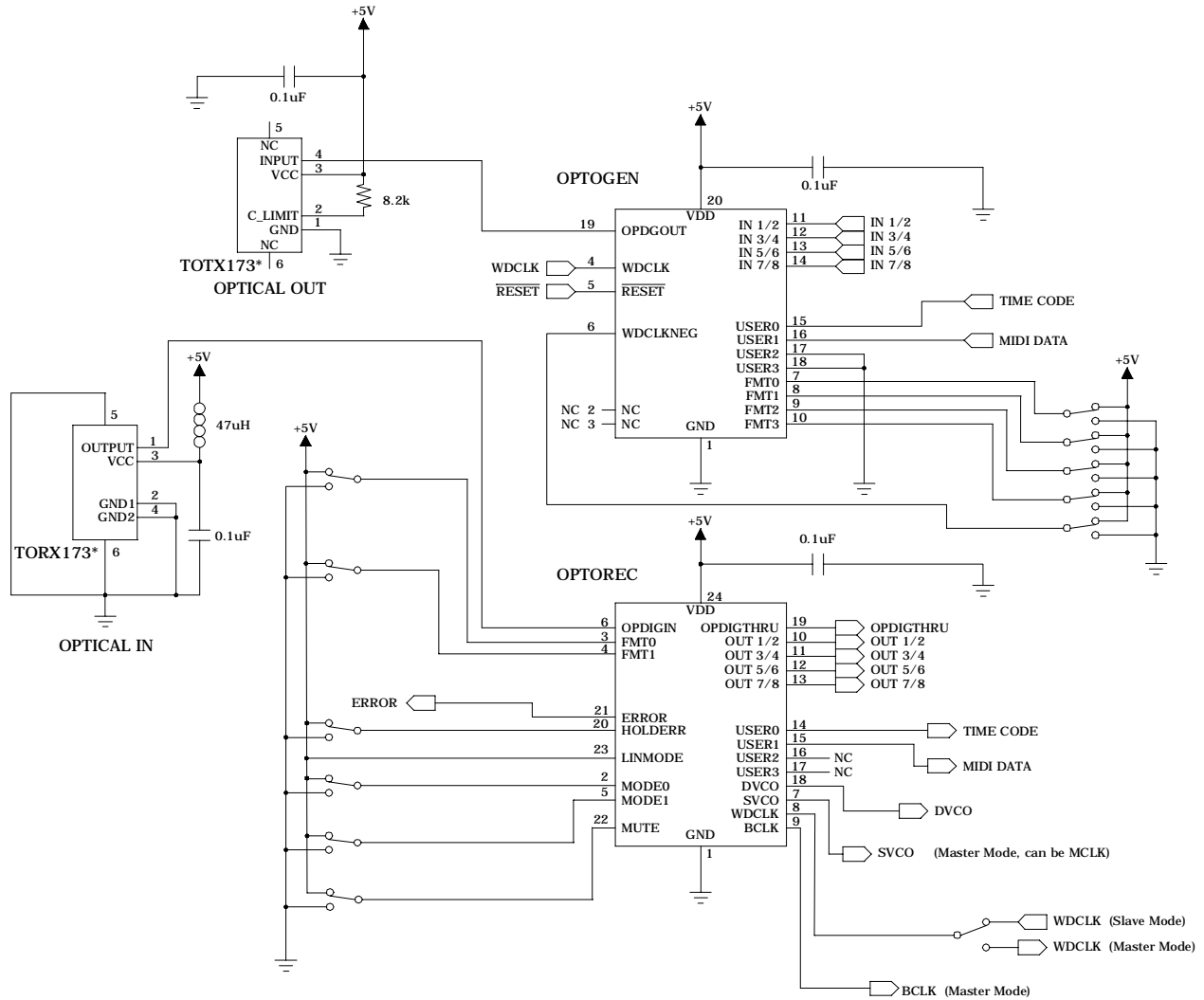

Figure D. Mechanical Drawing

Sample Application Schematic



* Optical I/O parts shown are Toshiba parts. The Sharp GP1F33RT or equivalent is also compatible.

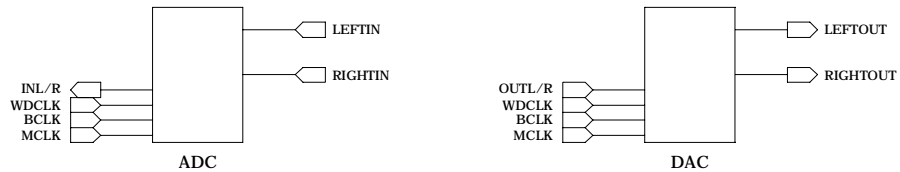

Figure E. OptoGen/OptoRec setup

The OptoGen accepts input from an ADC, then outputs the Alesis optical format. The OptoRec accepts input in Alesis optical format, then outputs to a DAC.



NOTICE

Alesis Semiconductor reserves the right to make changes to their products or to discontinue any product or service without notice. All products are sold subject to terms and conditions of sale supplied at the time of order acknowledgement. Alesis Semiconductor assumes no responsibility for the use of any circuits described herein, conveys no license under any patent or other right, and makes no representation that the circuits are free of patent infringement. Information contained herein are only for illustration purposes and may vary depending upon a user's specific application. While the information in this publication has been carefully checked, no responsibility is assumed for inaccuracies.

Alesis Semiconductor products are not designed for use in applications which involve potential risks of death, personal injury, or severe property or environmental damage or life support applications where the failure or malfunction of the product can reasonably be expected to cause failure of the life support system or to significantly affect its safety or effectiveness.

All trademarks and registered trademarks are property of their respective owners.

Contact Information:

Alesis Semiconductor
12555 Jefferson Blvd., Suite 285
Los Angeles, CA 90066
Phone: (310) 301-0780
Fax: (310) 306-1551

Email: sales@alesis-semi.com

Copyright 2002 Alesis Semiconductor
Datasheet July 2002

Reproduction, in part or in whole, without the prior written consent of Alesis Semiconductor is prohibited.