

GaAs IC 5 Bit Digital Attenuator

0.5 dB LSB Positive Control 0.5–2.0 GHz



AA106-86

Features

- Attenuation 0.5 dB Steps to 15.5 dB with High Accuracy
- Single Positive Control (+3 to +5 V) for Each Bit
- Low DC Power Consumption
- Miniature Low Cost MSOP-10 Plastic Package

Description

The AA106-86 is a 5 bit, single positive control GaAs IC FET digital attenuator in a low cost MSOP-10 package. This attenuator has an LSB of 0.5 dB and a total attenuation of 15.5 dB. The attenuator requires external DC blocking capacitors, positive supply voltage (V_S) and five individual bit control voltages (V_1 – V_5). The AA106-86 is particularly suited where high attenuation accuracy, low insertion loss and low intermodulation products are required. Typical applications include cellular radio, wireless data, and wireless local loop gain level control circuits.

MSOP-10

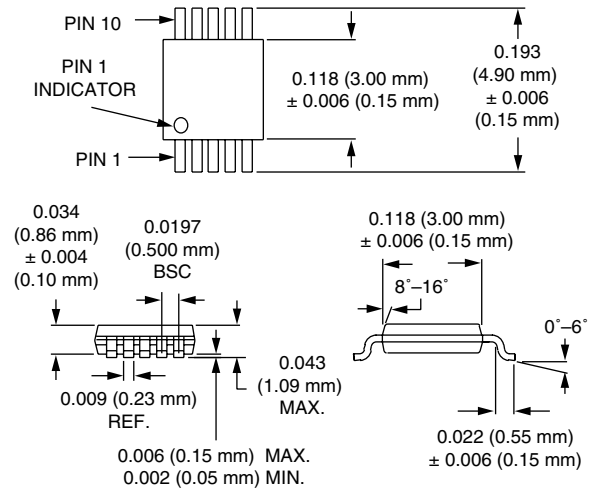

Electrical Specifications at 25°C (0, +3 V), (0, +5 V)

Parameter ¹	Frequency	Min.	Typ.	Max.	Unit
Insertion Loss ²	0.5–1.0 GHz		2.0	2.4	dB
	1.0–2.0 GHz		3.0	3.4	dB
Attenuation Range			15.5		dB
Attenuation Accuracy ³	0.5–1.0 GHz	± (0.2 + 3% of Attenuation Setting in dB)			dB
	1.0–2.0 GHz	± (0.3 + 5% of Attenuation Setting in dB)			dB
VSWR (I/O)	0.5–2.0 GHz		1.5:1	2.0:1	

Operating Characteristics at 25°C (0, +5 V)

Parameter	Condition	Frequency	Min.	Typ.	Max.	Unit
Switching Characteristics ⁴	Rise, Fall (10/90% or 90/10% RF)			150		ns
	On, Off (50% CTL to 90/10% RF)			300		ns
	Video Feedthru			70		mV
Input Power for 1 dB Compression	$V_S = +3 V$	0.9–2.0 GHz		+21		dBm
	$V_S = +5 V$	0.9–2.0 GHz		+27		dBm
Intermodulation Intercept Point (IP3)	For Two-tone Input Power +5 dBm $V_S = +3 V$ $V_S = +5 V$	0.9–2.0 GHz		+41		dBm
		0.9–2.0 GHz		+45		dBm
Control Voltages	$V_{Low} = 0$ to 0.2 V @ 20 μA Max. $V_{High} = +3 V$ @ 100 μA Max. to +5 V @ 200 μA Max. $V_S = V_{High} \pm 0.2 V$					

1. All measurements made in a 50 Ω system, unless otherwise specified.

2. Insertion loss changes by 0.003 dB/°C.

3. Attenuation referenced to insertion loss.

4. Video feedthru measured with 1 ns risetime pulse and 500 MHz bandwidth.

Typical Performance Data (0, +5 V)

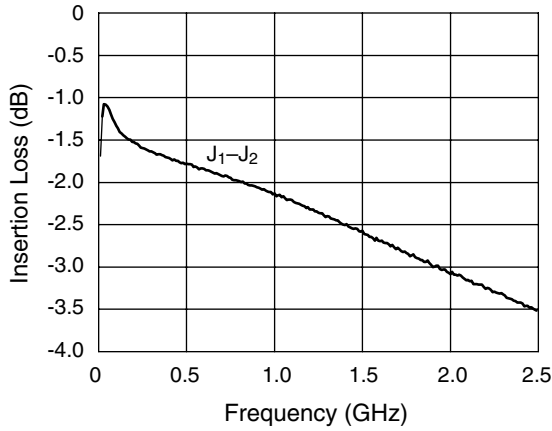

Insertion Loss vs. Frequency

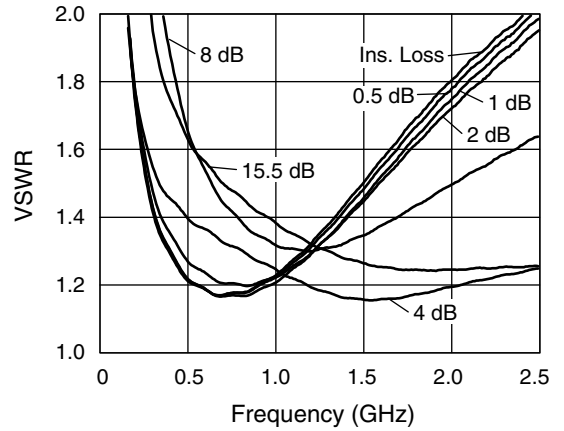

VSWR vs. Frequency

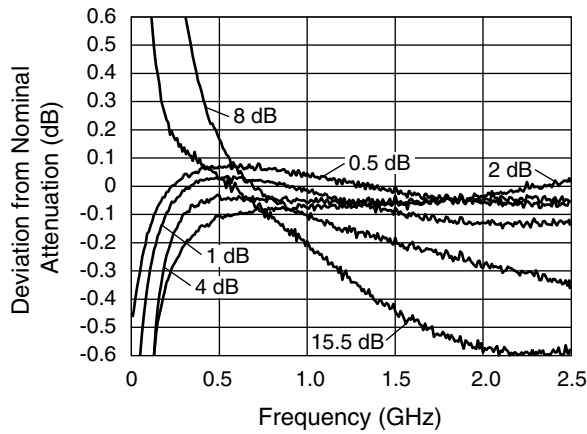

Attenuation Accuracy vs. Frequency

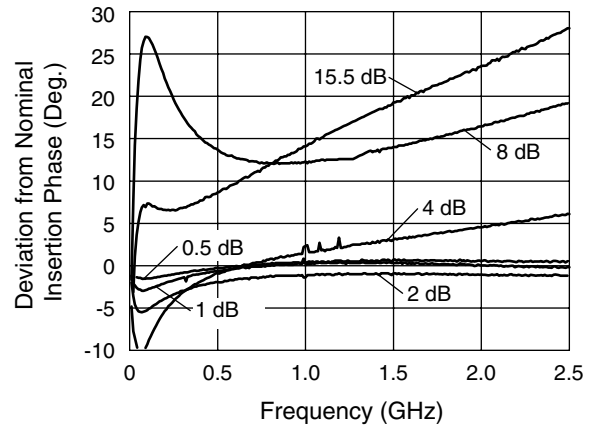

Attenuation Phase Accuracy vs. Frequency

Truth Table

V ₁	V ₂	V ₃	V ₄	V ₅	Attenuation J ₁ -J ₂
8 dB	4 dB	2 dB	1 dB	0.5 dB	Reference I.L.
V _{High}	V _{High}	V _{High}	V _{High}	V _{High}	0.5 dB
V _{High}	V _{High}	V _{High}	V _{High}	0	1 dB
V _{High}	V _{High}	0	V _{High}	V _{High}	2 dB
V _{High}	0	V _{High}	V _{High}	V _{High}	4 dB
0	V _{High}	V _{High}	V _{High}	V _{High}	8 dB
0	0	0	0	0	15.5 dB Max. Atten.

V_{High} = +3 to +5 V (V_S = V_{High} ± 0.2 V).

Pin Out

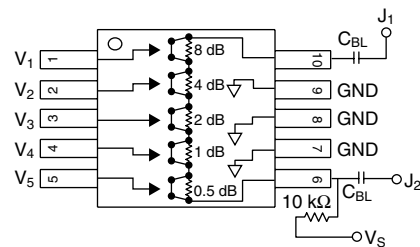

DC blocking capacitors (C_{BL}) and biasing resistor must be supplied externally for positive voltage operation.
C_{BL} = 47 pF for operation >500 MHz.

Typical Performance Data (0, +3 V)

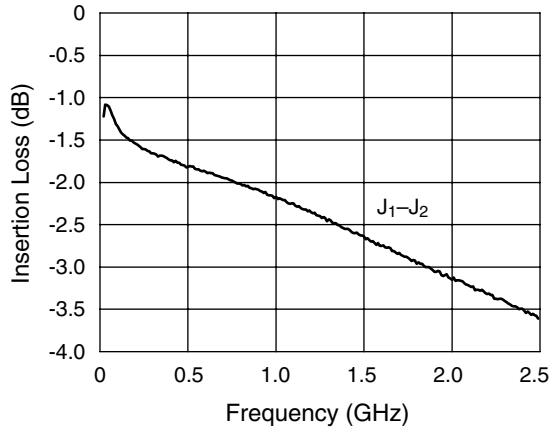

Insertion Loss vs. Frequency

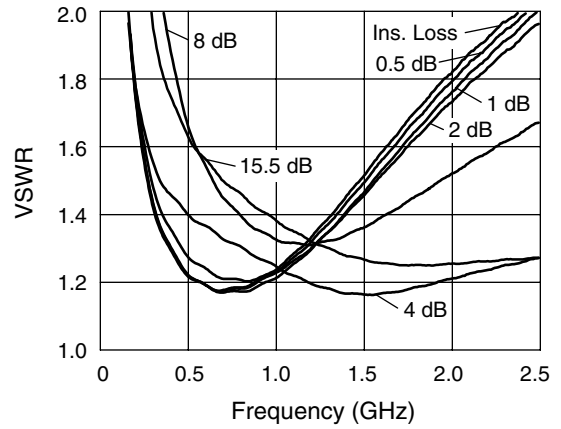

VSWR vs. Frequency

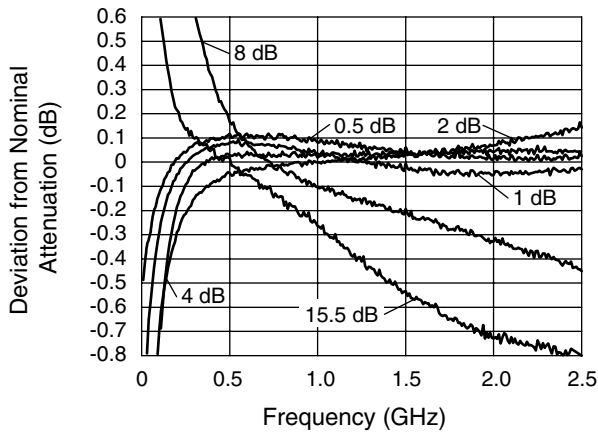

Attenuation Accuracy vs. Frequency

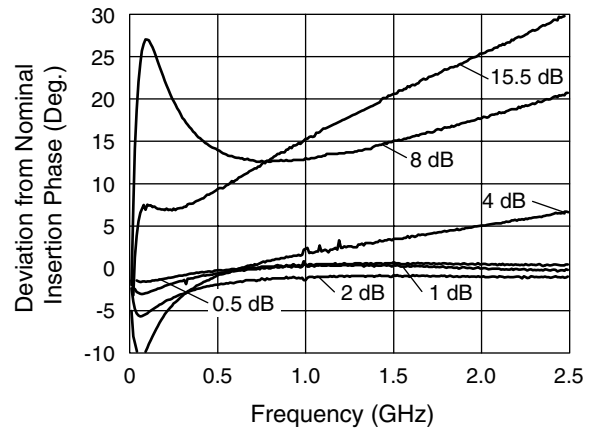

Attenuation Phase Accuracy vs. Frequency

Absolute Maximum Ratings

Characteristic	Value
RF Input Power	1 W > 500 MHz 0/8 V 0.5 W @ 50 MHz 0/8 V
Supply Voltage	+8 V
Control Voltage	-0.2 V, +8 V
Operating Temperature	-40°C to +85°C
Storage Temperature	-65°C to +150°C

Note: Exceeding these parameters may cause irreversible damage.