

# GaAs PHEMT Switchable Gain LNA



AL108-338

## Features

- For 3.2–3.8 GHz Fixed Wireless Applications
- Adjustable Gain
- +7 dBm Output Power
- +17 dBm Output IP3
- 2.7 dB Noise Figure
- Single +5 V Supply
- Input and Output Matched to 50  $\Omega$

## Description

The AL108-338 is an LNA designed for use in 3.2–3.8 GHz WLAN applications. The leadless surface mount package houses a GaAs PHEMT MMIC that yields low noise, good 50  $\Omega$  match, high gain and powerful  $P_{1\text{ dB}}$  performance. Powered by a single 5 V supply, it also offers a 10 dB gain adjustment range.

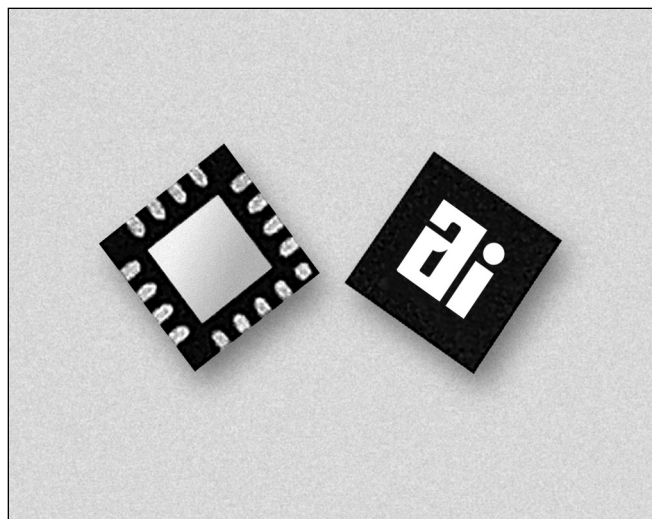

## Absolute Maximum Ratings

Characteristic	Value
RF Input Power	20 dBm
Bias Voltage	6 V Max.
Storage Temperature	-40 to +85°C
Operating Temperature	-65 to +150°C

## Electrical Specifications at 25°C (3.2–3.8 GHz)

Control Voltage = 0 V, Bias Voltage = 5 V,  $I_D = 85\text{ mA}$

Parameter	Condition	Frequency	Min.	Typ.	Max.	Unit
Gain			19	21		dB
Output $P_{-1\text{ dB}}$				6		dBm
Output IP3	$P_{IN} = -30\text{ dBm}$		18	19		dBm
Noise Figure				2.5	2.9	dB
Reverse Isolation			30	40		dB
Input VSWR	50 $\Omega$ System			1.5:1	2.0:1	
Output VSWR	50 $\Omega$ System			1.5:1	2.0:1	

Control Voltage = 5 V, Bias Voltage = 5 V,  $I_D = 85\text{ mA}$

Parameter	Condition	Frequency	Min.	Typ.	Max.	Unit
Gain			8	10		dB
Output $P_{-1\text{ dB}}$				6		dBm
Output IP3	$P_{IN} = -30\text{ dBm}$		20	23		dBm
Noise Figure				9	10	dB
Reverse Isolation			30	40		dB
Input VSWR	50 $\Omega$ System			1.5:1	2.0:1	
Output VSWR	50 $\Omega$ System			1.5:1	2.0:1	

**Typical Performance Data at 25°C**

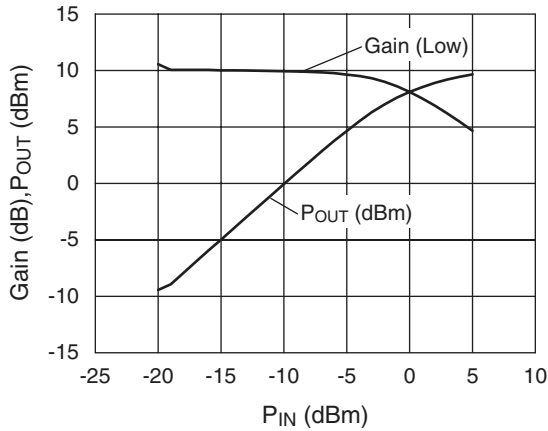

**Gain and Output Power (Low Gain mode)**

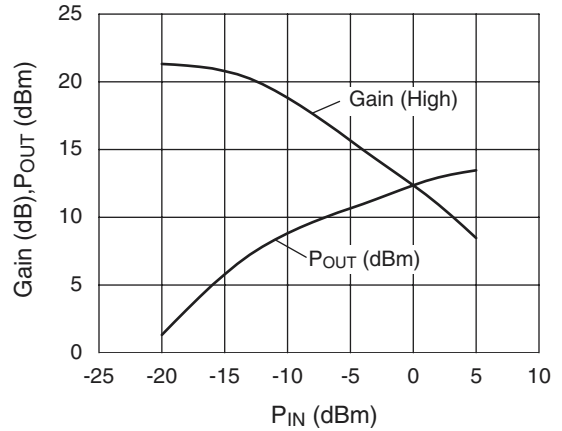

**Gain and Output Power (High Gain mode)**

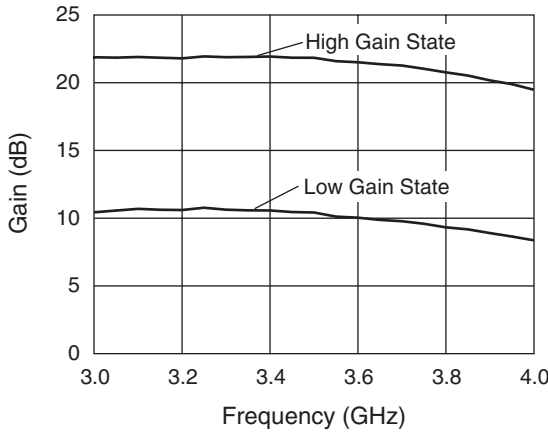

**Gain vs. Frequency**

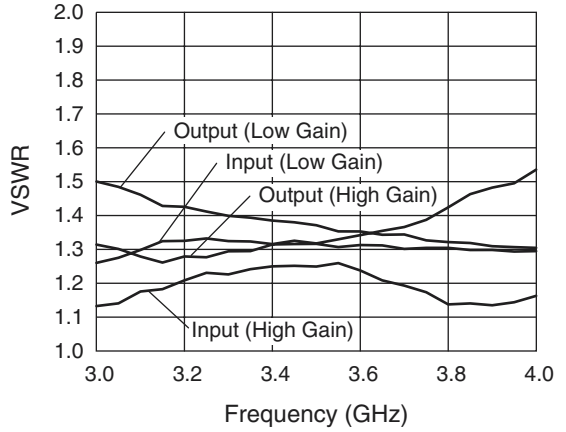

**VSWR vs. Frequency**

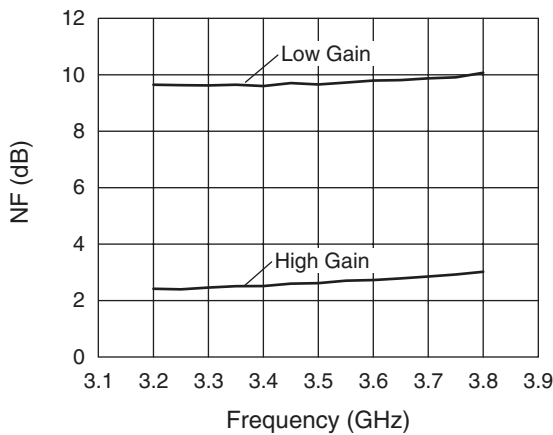

**Noise Figure vs. Frequency**

**Evaluation Board**

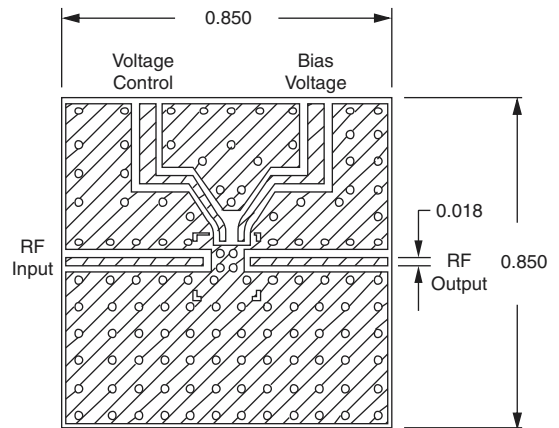

Dimensions in inches.

**Pin Out (Top View)**

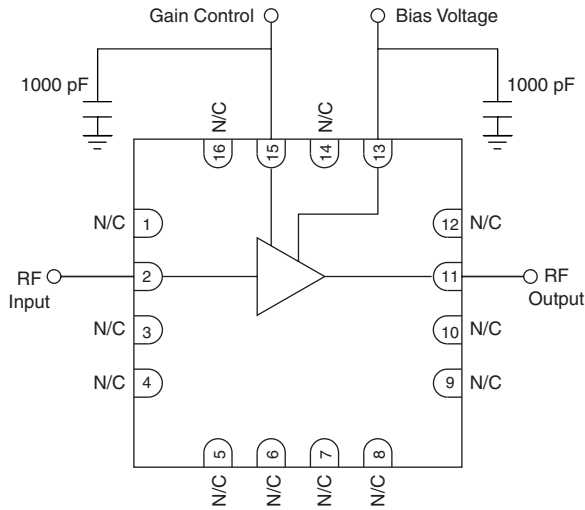

Ground is connected to paddle on bottom.

**Package Outline (Bottom View)**

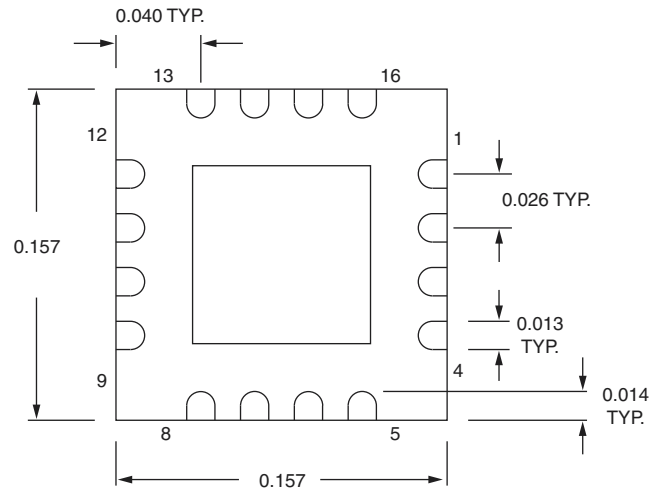

**Truth Table**

Low Gain	$V_C = 5\text{ V}$
High Gain	$V_C = 0\text{ V}$

**Typical S-Parameters (Control Voltage 0/+5 V)**

Low Gain State # GHZ S MA R 50									High Gain State # GHZ S MA R 50							
Freq. (GHz)	S <sub>11</sub>	S <sub>11a</sub>	S <sub>21</sub>	S <sub>21a</sub>	S <sub>12</sub>	S <sub>12a</sub>	S <sub>22</sub>	S <sub>22a</sub>	S <sub>11</sub>	S <sub>11a</sub>	S <sub>21</sub>	S <sub>21a</sub>	S <sub>12</sub>	S <sub>12a</sub>	S <sub>22</sub>	S <sub>22a</sub>
1.0	0.0531	65.99	0.1093	132.60	0.0081	25.28	0.2937	-93.69	0.5023	11.44	0.2221	-171.21	0.0013	-19.22	0.2935	-93.51
1.5	0.1204	91.60	0.4417	2.26	0.0054	-24.99	0.2428	-84.55	0.3677	-60.06	2.2489	65.05	0.0055	91.43	0.2265	-86.97
2.0	0.1362	14.12	1.3032	-101.06	0.0042	-17.39	0.2899	-73.12	0.4475	-131.33	10.3201	-81.96	0.0066	97.84	0.346	-60.19
2.5	0.1651	-29.48	2.5615	153.17	0.0024	11.52	0.323	-74.12	0.1954	-1.39	13.8498	143.35	0.0036	69.36	0.359	-88.94
3.0	0.1572	13.82	3.7729	53.89	0.0059	35.81	0.3019	-83.48	0.1133	-15.23	13.6149	42.94	0.0062	70.40	0.2228	-80.36 4
4.0	0.4082	4.29	2.9632	-128.83	0.0055	-55.78	0.0637	17.93	0.2741	-14.00	10.2202	-144.57	0.006	-16.85	0.0713	12.81
4.5	0.5055	-4.96	1.9123	157.00	0.0063	-83.69	0.267	36.24	0.324	-9.03	5.7473	131.66	0.0009	-29.68	0.2643	34.37
5.0	0.5351	-14.30	1.1534	92.88	0.0027	-148.15	0.3803	26.63	0.3458	-8.19	2.7131	59.91	0.003	-119.30	0.3786	27.80
5.5	0.4906	-31.11	0.6649	35.33	0.0062	-179.25	0.4498	21.69	0.2818	-14.80	1.1847	0.28	0.0025	-177.50	0.4481	20.63
6.0	0.2427	-72.20	0.3686	-25.59	0.0079	138.81	0.44	18.28	0.1318	34.49	0.4931	-55.56	0.0039	170.99	0.4398	18.02

Measured S-Parameters represent the packaged device.