

# Very Low Distortion Attenuator Plastic Packaged PIN Diodes



## SMP1307 Series

### Features

- Low Distortion Design
- Frequency Range from HF to > 2 GHz
- Designed for CATV AGC Applications
- Designed for High Volume Wireless Applications

### Description

The SMP1307 series of plastic packaged, surface mountable, low capacitance (0.3 pF) silicon PIN diodes are designed for use in attenuator applications from 5 MHz to beyond 2 GHz. The thick 175  $\mu\text{m}$  I region of these PIN diodes makes them very attractive for use in very low distortion PI and TEE attenuators commonly used in TV distribution applications. The 1.5  $\mu\text{S}$  typical carrier lifetime of these diodes results in resistance of 100  $\Omega$  maximum at 1 mA and 10  $\Omega$  maximum at 10 mA. Available in a selection of plastic packages, as a single diode in the small footprint SOD-323, and in a variety of configurations in the SOT-23. Also available in a SOT-5 (SMP1307-027) package as a four diode array designed for insertion in the commonly used 4 diode PI attenuator circuit.

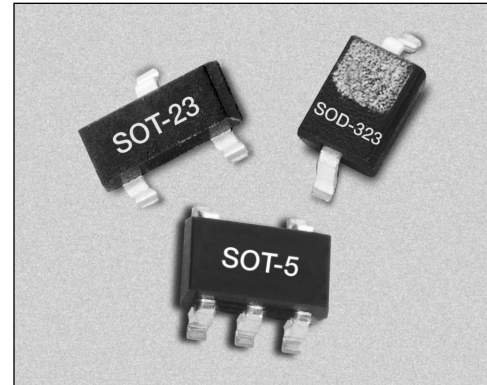

### Absolute Maximum Ratings

Characteristic	Value
Reverse Voltage ( $V_R$ )	200 V
Power Dissipation @ 25°C Lead Temperature ( $P_D$ )	250 mW
Storage Temperature ( $T_{ST}$ )	-65°C to +150°C
Operating Temperature ( $T_{OP}$ )	-65°C to +150°C
ESD Human Body Model	Class 1C

Single	Common Cathode	Series Pair	Single	PI
Marking: PJ1	Marking: PJ3	Marking: PJ2		Marking: PJM
SOT-23	SOT-23	SOT-23	SOD-323	SOT-5
♦ SMP1307-001	♦ SMP1307-004	♦ SMP1307-005	♦ SMP1307-011	♦ SMP1307-027
$L_S = 1.5 \text{ nH}$	$L_S = 1.5 \text{ nH}$	$L_S = 1.5 \text{ nH}$	$L_S = 1.5 \text{ nH}$	

♦ Available through distribution.

### Electrical Specifications at 25°C

Parameter	Condition	Typ.	Max.	Unit
Reverse Current ( $I_R$ )	$V_R = 200 \text{ V}$		10	$\mu\text{A}$
Capacitance ( $C_T$ )	$F = 1 \text{ MHz}, V = 30 \text{ V}$		0.30	pF
Resistance ( $R_S$ )	$F = 100 \text{ MHz}, I = 1 \text{ mA}$	75	100	$\Omega$
Resistance ( $R_S$ )	$F = 100 \text{ MHz}, I = 10 \text{ mA}$		15	$\Omega$
Resistance ( $R_S$ )	$F = 100 \text{ MHz}, I = 100 \text{ mA}$		3.0	$\Omega$
Forward Voltage ( $V_F$ )	$I_F = 10 \text{ mA}$	0.85		V
Carrier Lifetime (TI)	$I_F = 10 \text{ mA}$	1.5		$\mu\text{S}$
I Region Width		175		$\mu\text{m}$

### Typical Performance Data

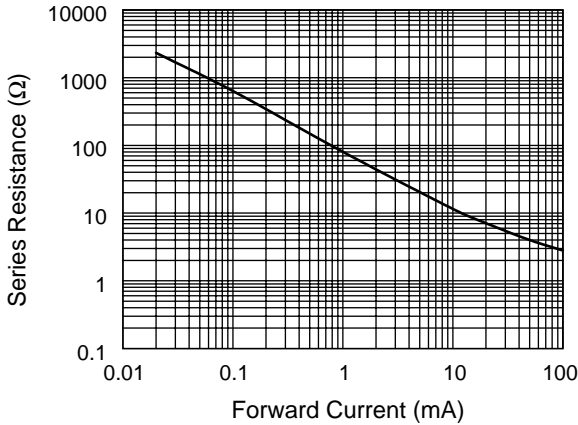

**Series Resistance vs. Current @ 100 MHz**

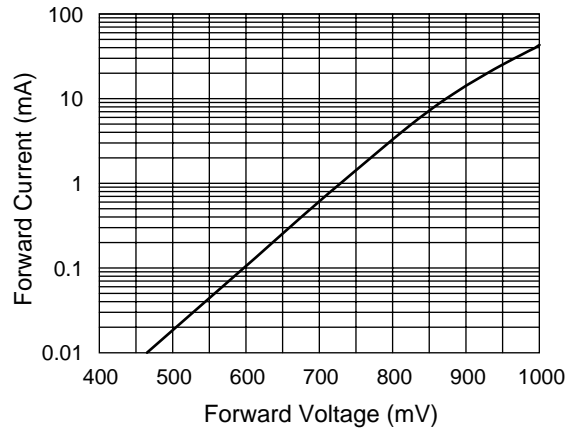

**DC Characteristic**

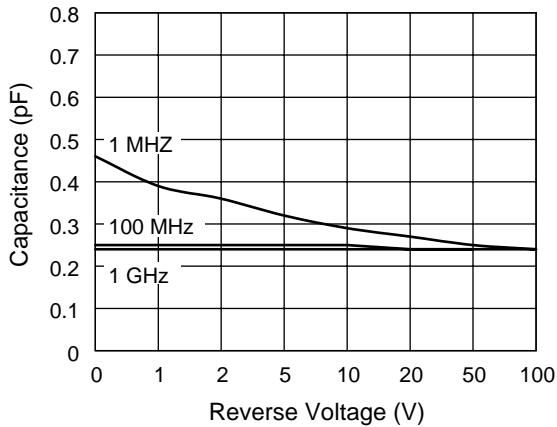

**Capacitance vs. Reverse Voltage**

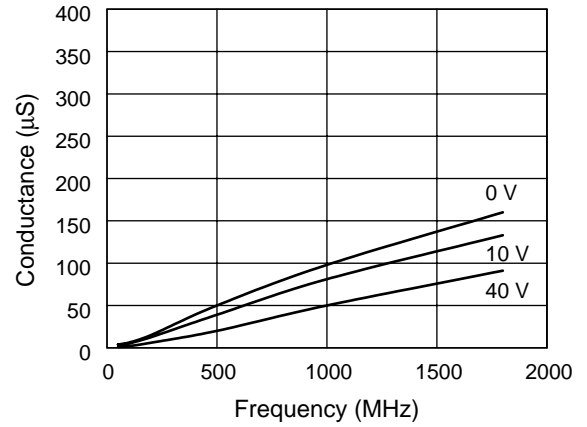

**Conductance vs. Frequency and Reverse Voltage**

### Resistance vs. Temperature @ 100 MHz

I <sub>F</sub> (mA)	R -55°C (Ω)	R -15°C (Ω)	R +25°C (Ω)	R +65°C (Ω)	R +100°C (Ω)
0.02	2386.0	2360.0	2546.0	2520.0	2440.0
0.10	572.0	598.0	632.0	633.0	639.0
0.30	203.0	219.0	236.0	239.0	242.0
1.00	66.1	71.2	79.3	83.6	85.4
10.00	9.1	10.0	10.9	12.2	12.9
20.00	5.6	6.0	6.6	7.4	7.8
100.00	2.2	2.4	2.6	3.0	3.2

### SMP1307-027 4 Diode PI Attenuator

The SMP1307-027 employs 4 PIN diode junctions in a 5-lead SOT package. It is configured for ease of insertion in the PI attenuator circuit commonly used for broadband TV distribution systems, covering a frequency range from 5 MHz to beyond 1 GHz.

A broadband attenuator was designed using the SMP1307-027 showing good performance to 2 GHz. The attenuator was evaluated with a 50 Ω source and load impedance. The following figure shows the circuit diagram and measured performance.

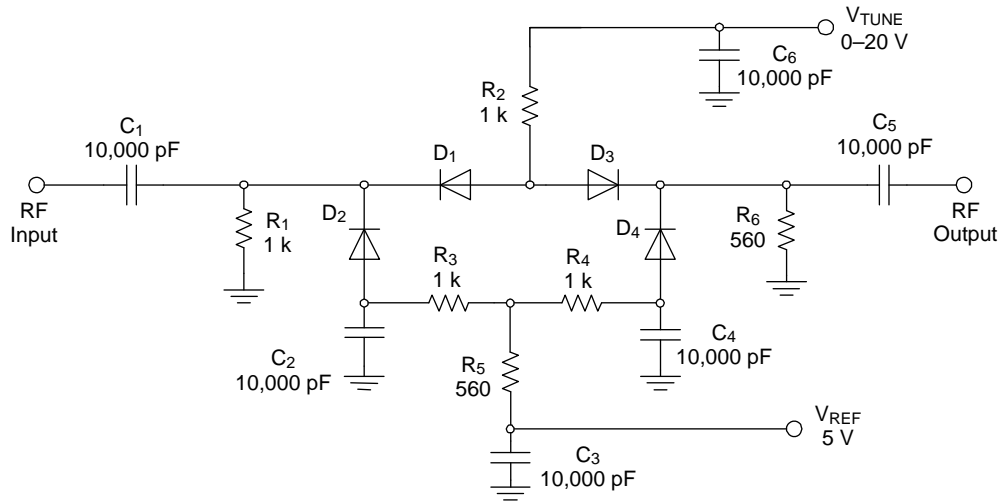
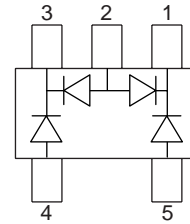

**D<sub>1</sub>-D<sub>4</sub> SMP1307-027**

A 4 diode PI attenuator utilizing individual SMP1307-011 PIN diodes is described in the “A Wideband General Purpose PIN Diode Attenuator” Application Note.

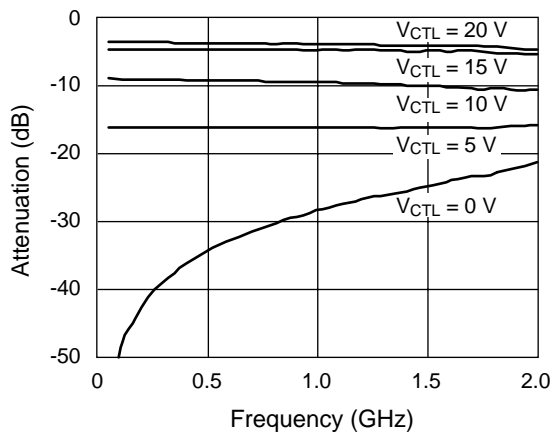

**SMP1307-027 Attenuation vs. Frequency**

**SOT-23**

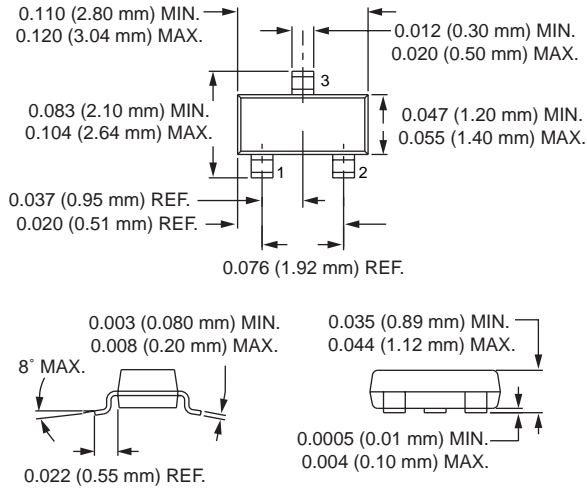

**SOT-5**

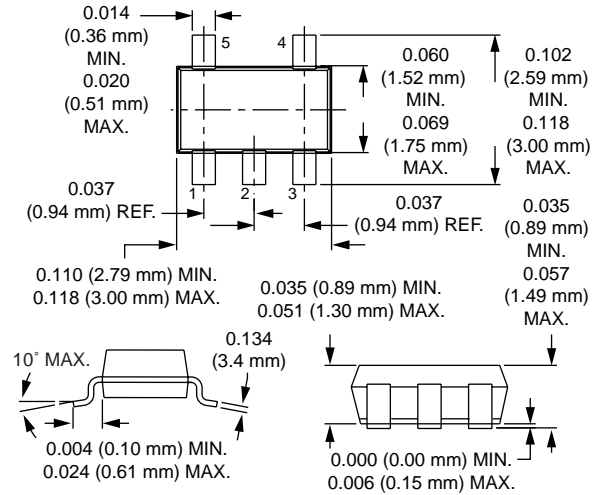

**SOD-323**

