

Hyperabrupt Junction Tuning Varactors



SMV1211–SMV1215

Features

- High Capacitance Ratio, $C_{1V}/C_{4V} = 5$ Typ.
- Multiple Packages SOT-23, SOD-323, SC-70 and SC-79
- Designed for High Volume Commercial Applications
- SPICE Models are Available

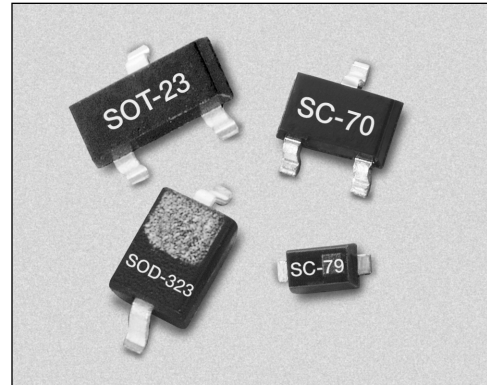





Description

The SMV1211–SMV1215 series of silicon hyperabrupt junction varactor diodes are designed for use in VCOs with low tuning voltage operation. This family of varactors is characterized for capacitance and resistance over temperature. SPICE models are provided.

Absolute Maximum Ratings

Characteristic	Value
Reverse Voltage (V_R)	12 V
Forward Current (I_F)	20 mA
Power Dissipation (P_D)	250 mW
Storage Temperature (T_{ST})	-55°C to +150°C
Operating Temperature (T_{OP})	-55°C to +125°C

				
Single	Single	Single	Common Cathode	Common Cathode
SC-79	SOD-323	SOT-23	SOT-23	SC-70
		† SMV1211-001		
† SMV1212-079		† SMV1212-001	† SMV1212-004	† SMV1212-074
† SMV1213-079	† SMV1213-011	† SMV1213-001	† SMV1213-004	† SMV1213-074
		† SMV1214-001		
	† SMV1215-011	† SMV1215-001		
$L_S = 0.7$ nH	$L_S = 1.5$ nH	$L_S = 1.5$ nH	$L_S = 1.4$ nH	$L_S = 1.4$ nH

† Available through distribution.

For other packages or configurations, please contact the factory.

Electrical Specifications at 25°C

Part Number	$C_T @ 1 V$ (pF)		$C_T @ 2.5 V$ (pF)		$C_T @ 4 V$ (pF)		$\frac{C_T @ 1 V}{C_T @ 2.5 V}$ (Ratio)	$\frac{C_T @ 1 V}{C_T @ 4 V}$ (Ratio)	$R_S @ 4 V$ 500 MHz (Ω)	$Q @ 4 V$ 50 MHz
	Min.	Typ.	Min.	Max.	Typ.	Max.	Typ.	Typ.	Typ.	Min.
SMV1211	95.0	100.0	40.0	65.0	20	25.0	2	5	0.4	80
SMV1212	42.0	50.0	18.0	27.0	9	12.0	2	5	0.8	150
SMV1213	17.0	22.0	8.5	10.5	4	5.5	2	5	1.4	200
SMV1214	14.5	16.0	6.5	7.8	3	4.8	2	5	1.7	300
SMV1215	8.7	9.5	4.3	5.5	2	2.9	2	5	2.8	350

Reverse Voltage V_R ($I_R = 10 \mu A$): 12 V
 Reverse Current I_R ($V_R = 8 V$): 20 nA

Typical Performance Data

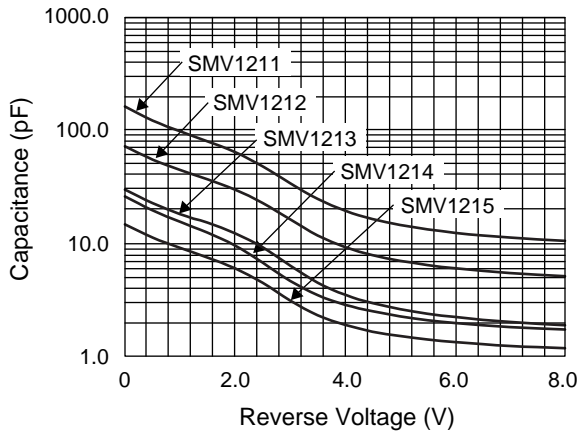

Capacitance vs. Reverse Voltage

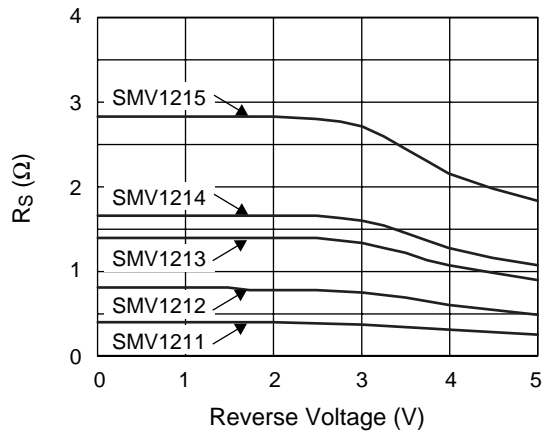

Series Resistance vs. Reverse Voltage @ 500 MHz

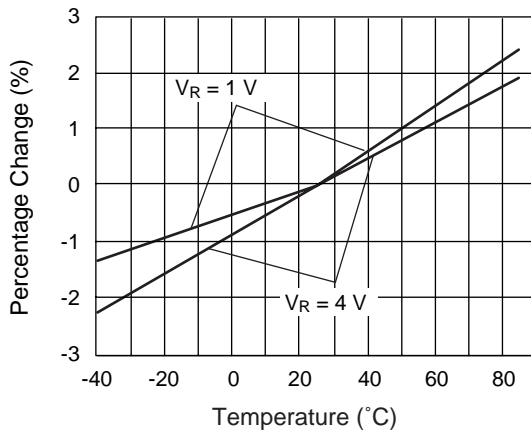

Relative Capacitance Change vs. Temperature

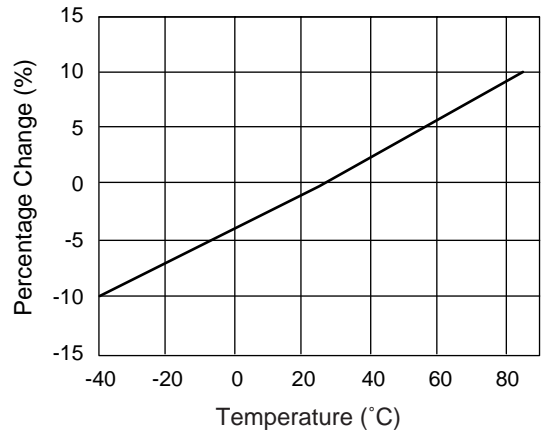

Relative Series Resistance Change vs. Temperature @ 500 MHz

Typical Capacitance Values

V _R (V)	SMV1211	SMV1212	SMV1213	SMV1214	SMV1215
	C _T (pF)	C _T (pF)	C _T (pF)	C _T (pF)	C _T (pF)
0.0	162.6	72.4	30.0	26.0	14.8
0.5	122.3	55.3	22.8	19.6	11.3
1.0	98.6	44.9	18.1	15.6	9.1
1.5	80.4	36.9	15.3	12.4	7.5
2.0	64.2	29.9	12.3	9.6	6.0
2.5	48.2	22.9	9.2	6.8	4.5
3.0	34.1	16.3	6.4	4.7	3.1
3.5	24.7	11.8	4.5	3.5	2.3
4.0	19.4	9.3	3.5	2.9	1.9
4.5	16.4	7.9	3.0	2.5	1.7
5.0	14.6	7.0	2.6	2.3	1.5
5.5	13.3	6.4	2.4	2.1	1.4
6.0	12.4	6.0	2.2	2.0	1.3
6.5	11.7	5.7	2.1	1.9	1.3
7.0	11.2	5.5	2.0	1.8	1.2
7.5	10.8	5.3	1.9	1.8	1.2
8.0	10.5	5.1	1.9	1.7	1.2

SPICE Model

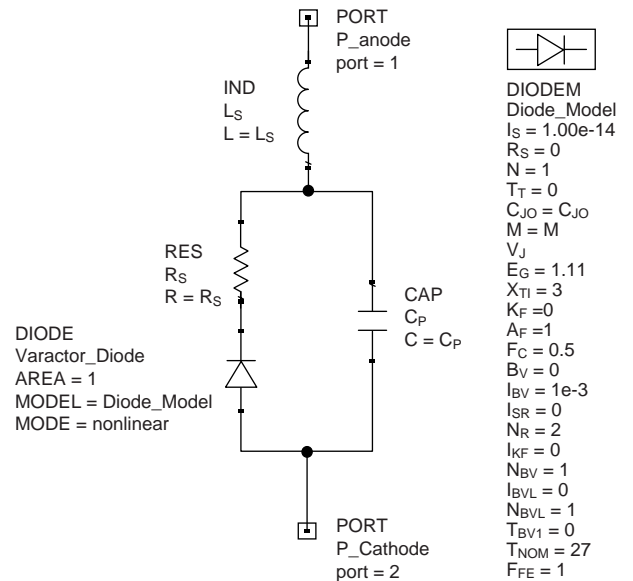

Part Number	C _{J0} (pF)	V _J (V)	M	C _P (pF)	R _S (Ω)
SMV1211	168.00	500	54	0.0	0.4
SMV1212	72.47	110	67	4.5	0.8
SMV1213	28.90	190	105	2.2	1.4
SMV1214	22.74	190	106	1.5	1.7
SMV1215	14.36	190	115	1.1	2.8

1. Values extracted from measured performance.
2. For package inductance (L_S) refer to package type.
3. For more details refer to the “Varactor SPICE Models for RF VCO Applications” Application Note.

SOT-23

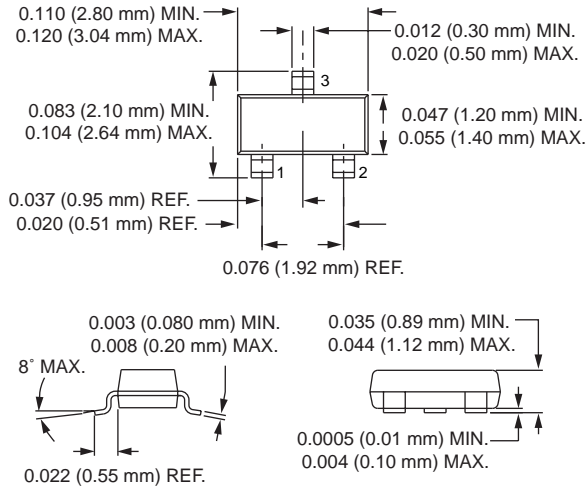

SC-70

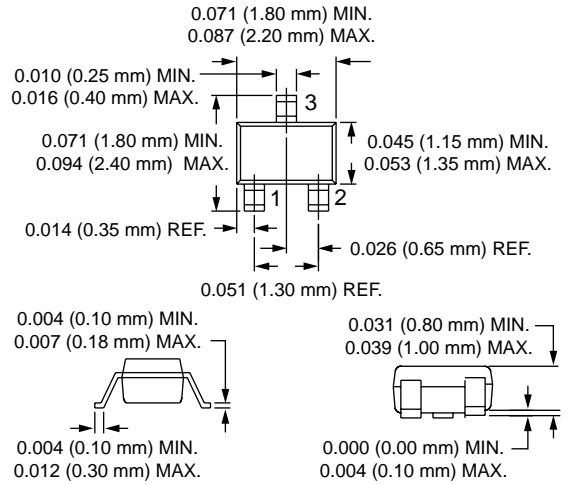

SOD-323

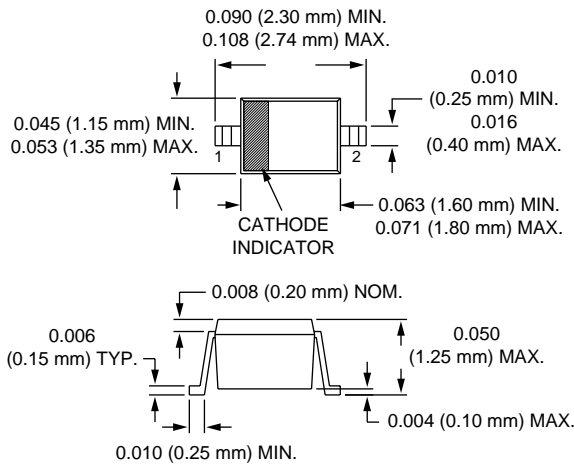

SC-79

