



## ***LP62S16256F-T Series***

***Preliminary***

***256K X 16 BIT LOW VOLTAGE CMOS SRAM***

---

### **Document Title**

**256K X 16 BIT LOW VOLTAGE CMOS SRAM**

### **Revision History**

<b><u>Rev. No.</u></b>	<b><u>History</u></b>	<b><u>Issue Date</u></b>	<b><u>Remark</u></b>
0.3	Change operation voltage from 2.7V~3.3V to 2.7V~3.6V Add -55ns specification	November 22, 2002	



# LP62S16256F-T Series

**Preliminary**

**256K X 16 BIT LOW VOLTAGE CMOS SRAM**

## Features

- Operating voltage: 2.7V to 3.6V
- Access times: 55ns / 70ns (max.)
- Current:
  - Very low power version: Operating: 40mA (max.)
  - Standby: 10µA (max.)
- Full static operation, no clock or refreshing required
- All inputs and outputs are directly TTL-compatible
- Common I/O using three-state output
- Data retention voltage: 2.0V (min.)
- Available in 44-pin TSOP and 48-ball CSP (6×8mm) packages

## General Description

The LP62S16256F-T is a low operating current 4,194,304-bit static random access memory organized as 262,144 words by 16 bits and operates on low power voltage from 2.7V to 3.6V. It is built using AMIC's high performance CMOS process.

Inputs and three-state outputs are TTL compatible and allow for direct interfacing with common system bus structures.

The chip enable input is provided for POWER-DOWN, device enable. Two byte enable inputs and an output enable input are included for easy interfacing.

Data retention is guaranteed at a power supply voltage as low as 2.0V.

## Product Family

Product Family	Operating Temperature	VCC Range	Speed	Power Dissipation			Package Type
				Data Retention (I <sub>CCDR</sub> , Typ.)	Standby (I <sub>SB1</sub> , Typ.)	Operating (I <sub>CC2</sub> , Typ.)	
LP62S16256F-T	-25°C ~ +85°C	2.7V~3.6V	55ns / 70ns	0.08µA	0.3µA	5mA	44L TSOP 48B CSP

1. Typical values are measured at VCC = 3.0V, T<sub>A</sub> = 25°C and not 100% tested.
2. Data retention current VCC = 2.0V.

## Pin Configurations

### ■ TSOP

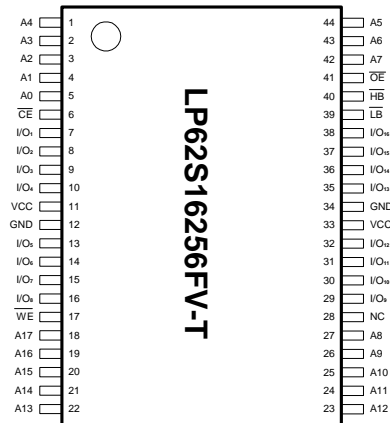

### ■ CSP (Chip Size Package) 48-pin Top View

	1	2	3	4	5	6
A	$\overline{LB}$	$\overline{OE}$	A0	A1	A2	NC
B	I/O <sub>9</sub>	$\overline{HB}$	A3	A4	$\overline{CE}$	I/O <sub>1</sub>
C	I/O <sub>10</sub>	I/O <sub>11</sub>	A5	A6	I/O <sub>2</sub>	I/O <sub>3</sub>
D	GND	I/O <sub>12</sub>	A17	A7	I/O <sub>4</sub>	VCC
E	VCC	I/O <sub>13</sub>	NC	A16	I/O <sub>5</sub>	GND
F	I/O <sub>15</sub>	I/O <sub>14</sub>	A14	A15	I/O <sub>6</sub>	I/O <sub>7</sub>
G	I/O <sub>16</sub>	NC	A12	A13	$\overline{WE}$	I/O <sub>8</sub>
H	NC	A8	A9	A10	A11	NC

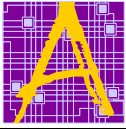

**Block Diagram**

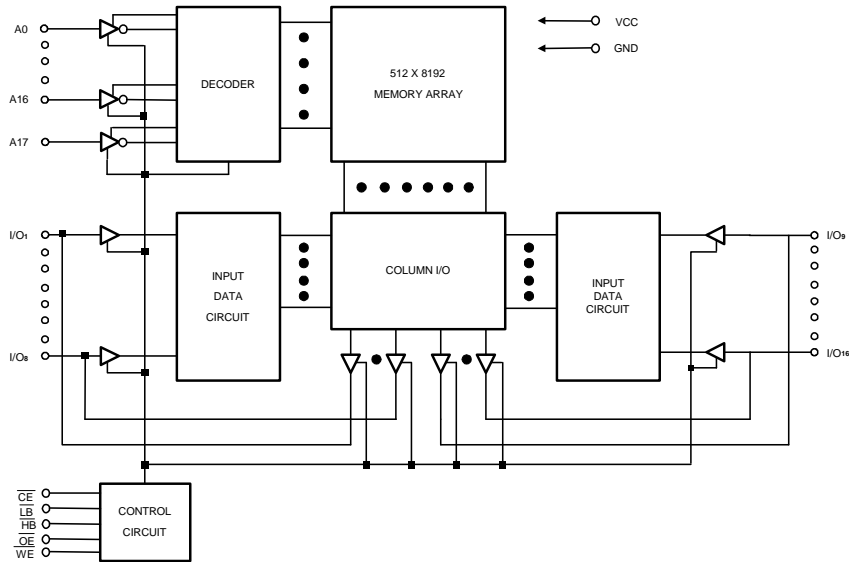

**Pin Descriptions -- TSOP**

Pin No.	Symbol	Description
1 - 5, 18 - 27, 42 - 44	A0 - A17	Address Inputs
6	$\overline{CE}$	Chip Enable Input
7 - 10, 13 - 16, 29 - 32, 35 - 38	I/O <sub>1</sub> - I/O <sub>16</sub>	Data Inputs/Outputs
17	$\overline{WE}$	Write Enable Input
39	$\overline{LB}$	Lower Byte Enable Input (I/O <sub>1</sub> to I/O <sub>8</sub> )
40	$\overline{HB}$	Higher Byte Enable Input (I/O <sub>9</sub> to I/O <sub>16</sub> )
41	$\overline{OE}$	Output Enable Input
11, 33	VCC	Power
12, 34	GND	Ground
28	NC	No Connection

**Pin Description - CSP**

Symbol	Description	Symbol	Description
A0 - A17	Address Inputs	$\overline{\text{HB}}$	Higher Byte Enable Input (I/O <sub>9</sub> - I/O <sub>16</sub> )
$\overline{\text{CE}}$	Chip Enable	$\overline{\text{OE}}$	Output Enable
I/O <sub>1</sub> - I/O <sub>16</sub>	Data Input/Output	VCC	Power Supply
$\overline{\text{WE}}$	Write Enable Input	GND	Ground
$\overline{\text{LB}}$	Byte Enable Input (I/O <sub>1</sub> - I/O <sub>8</sub> )	NC	No Connection

**Recommended DC Operating Conditions**(T<sub>A</sub> = -25°C to + 85°C)

Symbol	Parameter	Min.	Typ.	Max.	Unit
VCC	Supply Voltage	2.7	3	3.6	V
GND	Ground	0	0	0	V
V <sub>IH</sub>	Input High Voltage	2.2	-	VCC + 0.3	V
V <sub>IL</sub>	Input Low Voltage	-0.3	-	+0.6	V
C <sub>L</sub>	Output Load	-	-	30	pF
TTL	Output Load	-	-	1	-



Absolute Maximum Ratings\*

VCC to GND .....-0.5V to +4.0V
IN, IN/OUT Volt to GND ..... -0.5V to VCC + 0.5V
Operating Temperature, Topr .....-25°C to +85°C
Storage Temperature, Tstg.....-55°C to +125°C
Power Dissipation, Ptot.....0.7W

\*Comments

Stresses above those listed under "Absolute Maximum Ratings" may cause permanent damage to this device. These are stress ratings only. Functional operation of this device at these or any other conditions above those indicated in the operational sections of this specification is not implied or intended. Exposure to the absolute maximum rating conditions for extended periods may affect device reliability.

DC Electrical Characteristics (TA = -25°C to + 85°C, VCC = 2.7V to 3.6V, GND = 0V)

Table with 6 columns: Symbol, Parameter, LP62S16256F-55LLT / 70LLT (Min., Typ., Max.), Unit, Conditions. Rows include Input Leakage Current, Output Leakage Current, Active Power Supply Current, Dynamic Operating Current (Icc1, Icc2), Standby Current (Isb, Isb1), Output Low Voltage, and Output High Voltage.

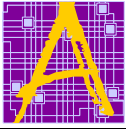
**Truth Table**

$\overline{CE}$	$\overline{OE}$	$\overline{WE}$	$\overline{LB}$	$\overline{HB}$	I/O <sub>1</sub> to I/O <sub>8</sub> Mode	I/O <sub>9</sub> to I/O <sub>16</sub> Mode	VCC Current
H	X	X	X	X	Not selected	Not selected	I <sub>SB1</sub> , I <sub>SB</sub>
X	X	X	H	H	High - Z	High - Z	I <sub>SB1</sub> , I <sub>SB</sub>
L	L	H	L	L	Read	Read	I <sub>CC1</sub> , I <sub>CC2</sub> , I <sub>CC</sub>
			L	H	Read	High - Z	I <sub>CC1</sub> , I <sub>CC2</sub> , I <sub>CC</sub>
			H	L	High - Z	Read	I <sub>CC1</sub> , I <sub>CC2</sub> , I <sub>CC</sub>
L	X	L	L	L	Write	Write	I <sub>CC1</sub> , I <sub>CC2</sub> , I <sub>CC</sub>
			L	H	Write	High - Z	I <sub>CC1</sub> , I <sub>CC2</sub> , I <sub>CC</sub>
			H	L	High - Z	Write	I <sub>CC1</sub> , I <sub>CC2</sub> , I <sub>CC</sub>
L	H	H	L	X	High - Z	High - Z	I <sub>CC1</sub> , I <sub>CC2</sub> , I <sub>CC</sub>
L	H	H	X	L	High - Z	High - Z	I <sub>CC1</sub> , I <sub>CC2</sub> , I <sub>CC</sub>

Note: X = H or L

**Capacitance** (T<sub>A</sub> = 25°C, f = 1.0MHz)

Symbol	Parameter	Min.	Max.	Unit	Conditions
C <sub>IN</sub> *	Input Capacitance		6	pF	V <sub>IN</sub> = 0V
C <sub>I/O</sub> *	Input/Output Capacitance		8	pF	V <sub>I/O</sub> = 0V

\* These parameters are sampled and not 100% tested.



**AC Characteristics** ( $T_A = -25^{\circ}\text{C}$  to  $+85^{\circ}\text{C}$ ,  $V_{CC} = 2.7\text{V}$  to  $3.6\text{V}$ )

Symbol	Parameter	LP62S16256F-55LLT		LP62S16256F-70LLT		Unit
		Min.	Max.	Min.	Max.	
Read Cycle						
t <sub>RC</sub>	Read Cycle Time	55	-	70	-	ns
t <sub>AA</sub>	Address Access Time	-	55	-	70	ns
t <sub>ACE</sub>	Chip Enable Access Time	-	55	-	70	ns
t <sub>BE</sub>	Byte Enable Access Time	-	55	-	70	ns
t <sub>OE</sub>	Output Enable to Output Valid	-	30	-	35	ns
t <sub>CLZ</sub>	Chip Enable to Output in Low Z	10	-	10	-	ns
t <sub>BLZ</sub>	Byte Enable to Output in Low Z	10	-	10	-	ns
t <sub>OLZ</sub>	Output Enable to Output in Low Z	5	-	5	-	ns
t <sub>CHZ</sub>	Chip Disable to Output in High Z	-	20	-	25	ns
t <sub>BHZ</sub>	Byte Disable to Output in High Z	-	20	-	25	ns
t <sub>OHZ</sub>	Output Disable to Output in High Z	-	20	-	25	ns
t <sub>OH</sub>	Output Hold from Address Change	5	-	5	-	ns
Write Cycle						
t <sub>WC</sub>	Write Cycle Time	55	-	70	-	ns
t <sub>CW</sub>	Chip Enable to End of Write	50	-	60	-	ns
t <sub>BW</sub>	Byte Enable to End of Write	50	-	60	-	ns
t <sub>AS</sub>	Address Setup Time	0	-	0	-	ns
t <sub>AW</sub>	Address Valid to End of Write	50	-	60	-	ns
t <sub>WP</sub>	Write Pulse Width	40	-	50	-	ns
t <sub>WR</sub>	Write Recovery Time	0	-	0	-	ns
t <sub>WHZ</sub>	Write to Output in High Z	-	25	-	25	ns
t <sub>DW</sub>	Data to Write Time Overlap	25	-	30	-	ns
t <sub>DH</sub>	Data Hold from Write Time	0	-	0	-	ns
t <sub>OW</sub>	Output Active from End of Write	5	-	5	-	ns

Note: t<sub>CHZ</sub>, t<sub>BHZ</sub> and t<sub>OHZ</sub> and t<sub>WHZ</sub> are defined as the time at which the outputs achieve the open circuit condition and are not referred to output voltage levels.

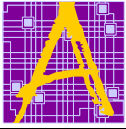

Timing Waveforms

Read Cycle 1<sup>(1, 2, 4)</sup>

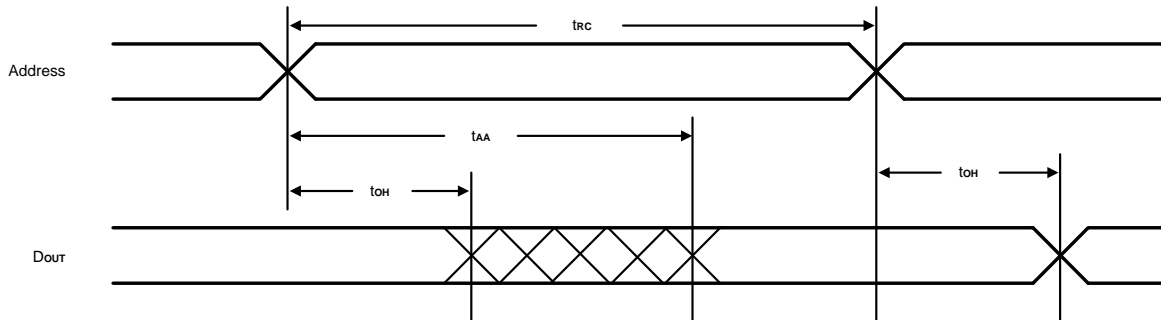

Read Cycle 2<sup>(1, 2, 3)</sup>

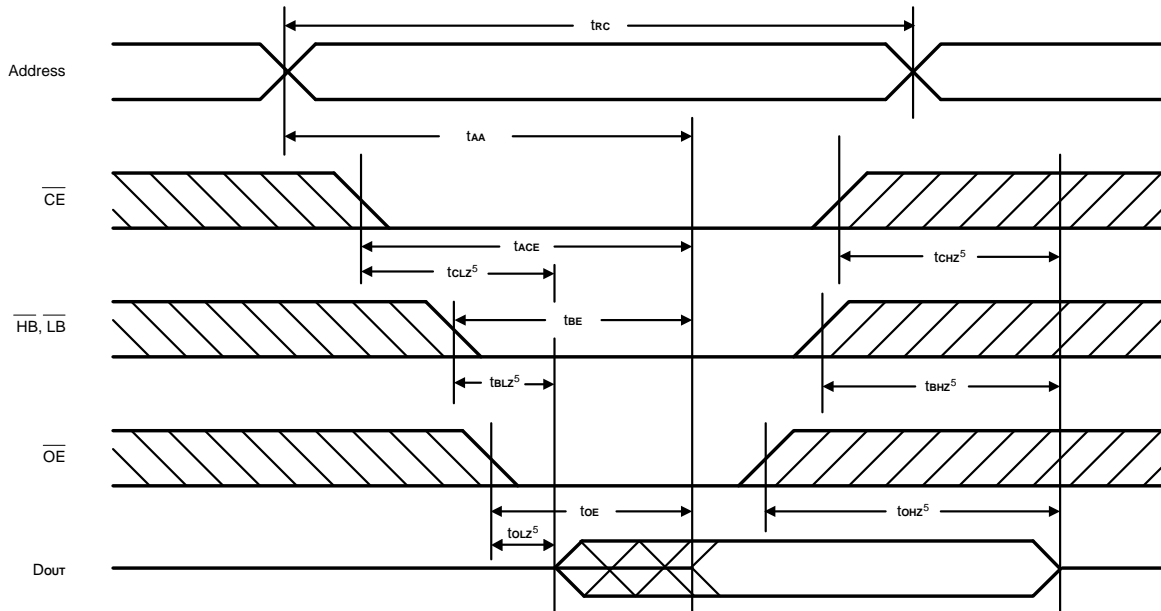

- Notes:
1.  $\overline{WE}$  is high for Read Cycle.
  2. Device is continuously enabled  $\overline{CE} = V_{IL}$ ,  $\overline{HB} = V_{IL}$  and, or  $\overline{LB} = V_{IL}$ .
  3. Address valid prior to or coincident with  $\overline{CE}$  and ( $\overline{HB}$  and, or  $\overline{LB}$ ) transition low.
  4.  $\overline{OE} = V_{IL}$ .
  5. Transition is measured  $\pm 500\text{mV}$  from steady state. This parameter is sampled and not 100% tested.





Timing Waveforms (continued)

Write Cycle 1  
(Write Enable Controlled)

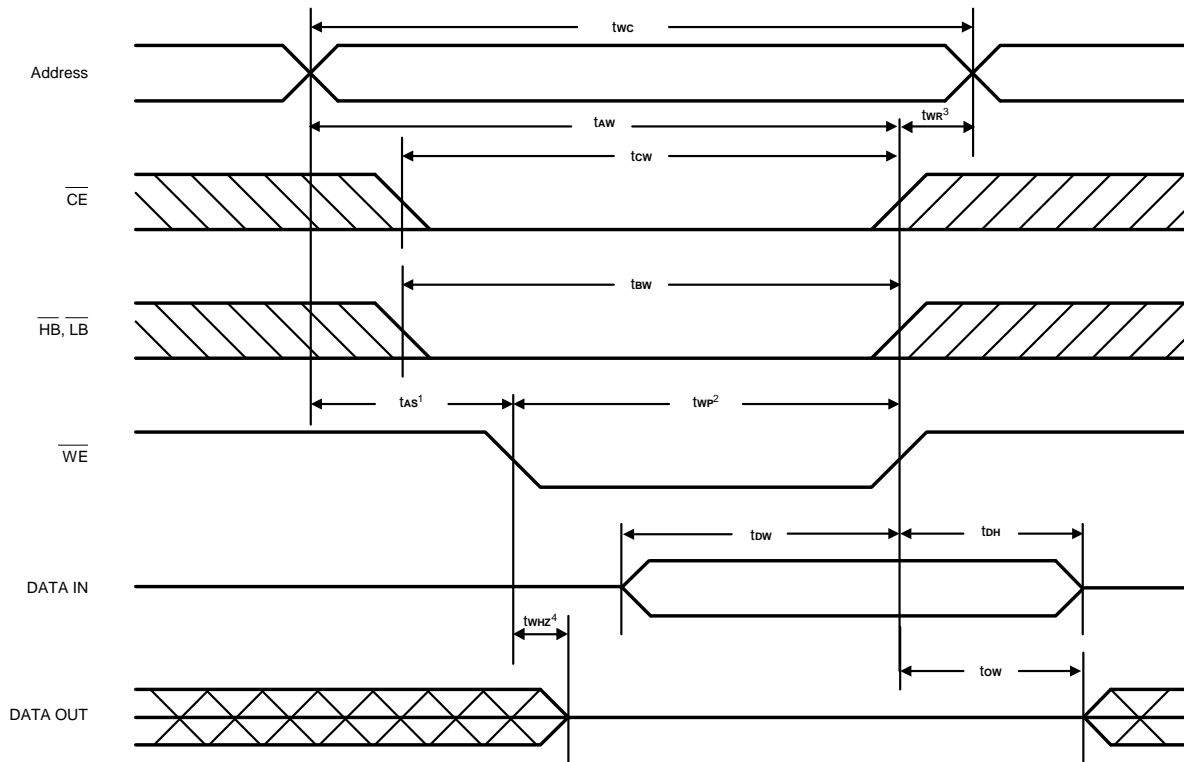



Timing Waveforms (continued)

Write Cycle 2  
(Chip Enable Controlled)

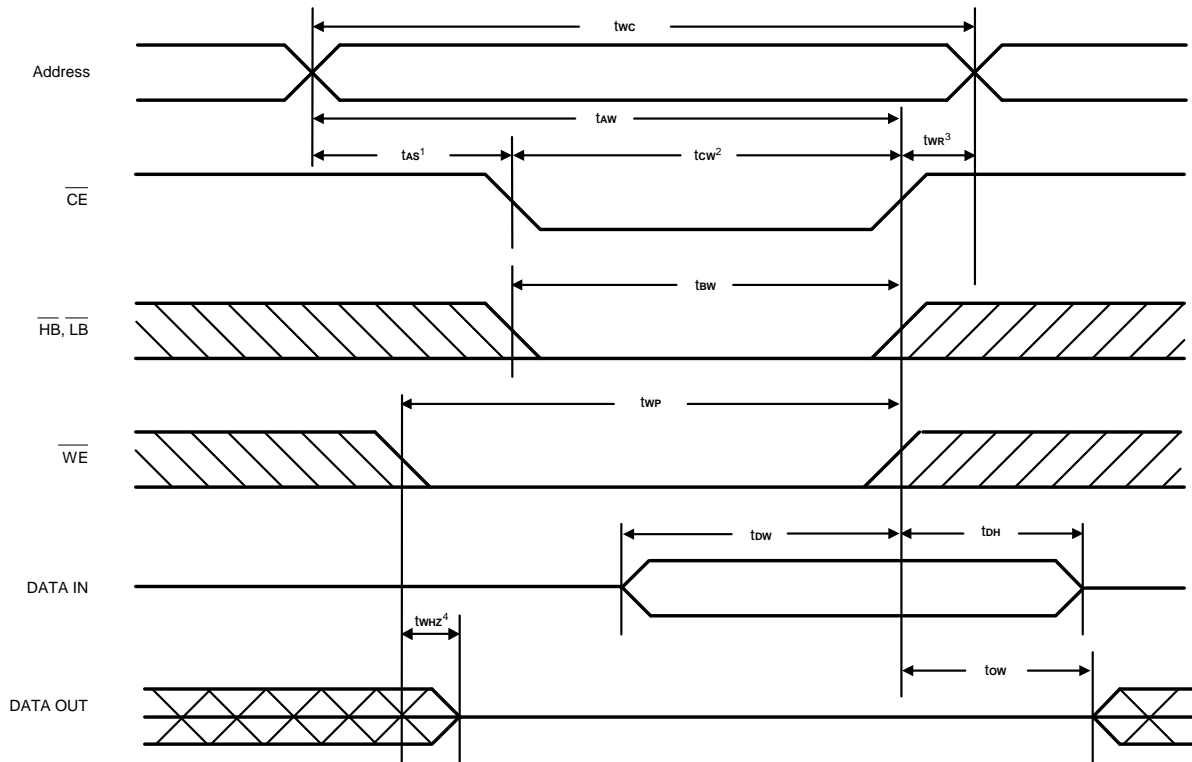

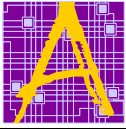

Timing Waveforms (continued)

Write Cycle 3  
(Byte Enable Controlled)

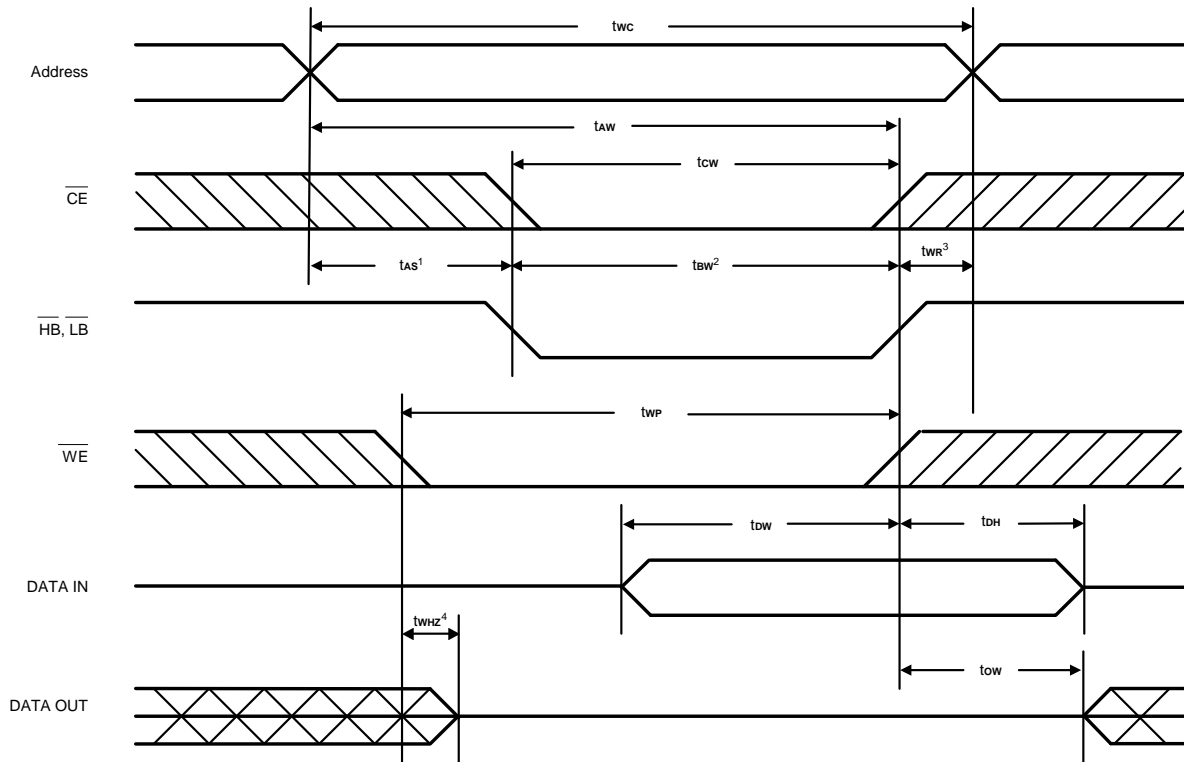

- Notes:
1.  $t_{as}$  is measured from the address valid to the beginning of Write.
  2. A Write occurs during the overlap ( $t_{wp}$ ,  $t_{bw}$ ) of a low  $\overline{CE}$ ,  $\overline{WE}$  and ( $\overline{HB}$  and , or  $\overline{LB}$ ).
  3.  $t_{wr}$  is measured from the earliest of  $\overline{CE}$  or  $\overline{WE}$  or ( $\overline{HB}$  and , or  $\overline{LB}$ ) going high to the end of the Write cycle.
  4.  $\overline{OE}$  level is high or low.
  5. Transition is measured  $\pm 500\text{mV}$  from steady state. This parameter is sampled and not 100% tested.

**AC Test Conditions**

Input Pulse Levels	0.4V to 2.4V
Input Rise And Fall Time	5 ns
Input and Output Timing Reference Levels	1.5V
Output Load	See Figures 1 and 2

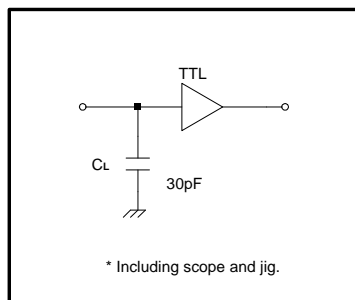
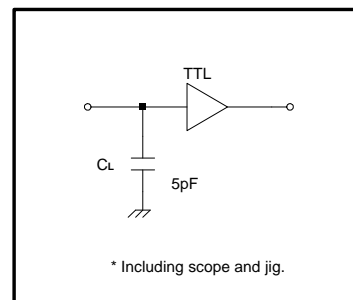
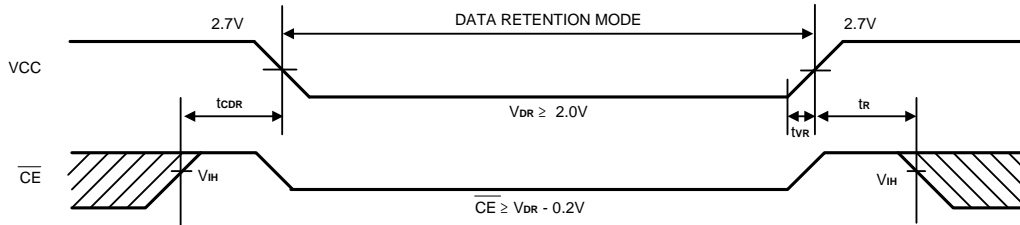

**Figure 1. Output Load**

**Figure 2. Output Load for  $t_{CLZ}$ ,  $t_{OLZ}$ ,  $t_{CHZ}$ ,  $t_{OHZ}$ ,  $t_{WHZ}$ , and  $t_{OW}$** 
**Data Retention Characteristics ( $T_A = -25^\circ\text{C}$  to  $85^\circ\text{C}$ )**

Symbol	Parameter	Min.	Typ.	Max.	Unit	Conditions
$V_{DR}$	VCC for Data Retention	2.0	-	3.6	V	$\overline{CE} \geq VCC - 0.2V$
$I_{CCDR}$	Data Retention Current	-	0.08	3*	$\mu\text{A}$	$VCC = 2.0V$ , $\overline{CE} \geq VCC - 0.2V$ $V_{IN} \geq 0V$
$t_{CDR}$	Chip Disable to Data Retention Time	0	-	-	ns	See Retention Waveform
$t_R$	Operation Recovery Time	$t_{RC}$	-	-	ns	
$t_{VR}$	VCC Rising Time from Data Retention Voltage to Operating Voltage	5	-	-	ms	

\* LP62S16256F-55LLT / 70LLT       $I_{CCDR}$ : max.  $1\mu\text{A}$  at  $T_A = 0^\circ\text{C}$  to  $+40^\circ\text{C}$



Low VCC Data Retention Waveform



Ordering Information

Part No.	Access Time (ns)	Operating Current Max. (mA)	Standby Current Max. (mA)	Package
LP62S16256FV-55LLT	55	40	10	44L TSOP
LP62S16256FU-55LLT		40	10	48L CSP
LP62S16256FV-70LLT	70	40	10	44L TSOP
LP62S16256FU-70LLT		40	10	48L CSP

**Package Information**
**TSOP 44L TYPE II Outline Dimensions**

unit: inches/mm

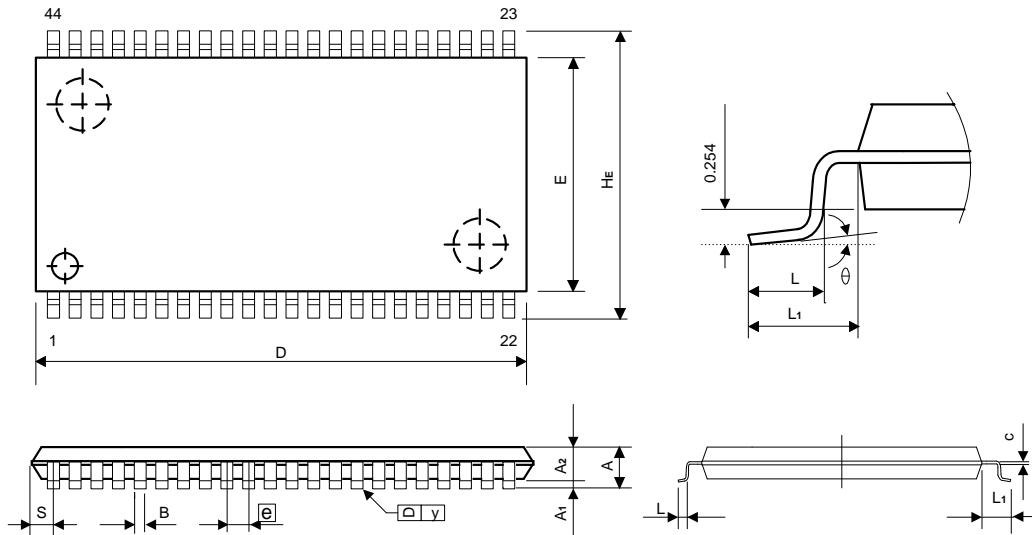

Symbol	Dimension in inch			Dimension in mm		
	Min.	Nom.	Max.	Min.	Nom.	Max.
A	-	-	0.047	-	-	1.20
A1	0.002	-	-	0.05	-	-
A2	0.037	0.039	0.041	0.95	1.00	1.05
B	0.010	0.014	0.018	0.25	0.35	0.45
c	-	0.006	-	-	0.15	-
D	0.721	0.725	0.729	18.31	18.41	18.51
E	0.396	0.400	0.404	10.06	10.16	10.26
e	-	0.031	-	-	0.80	-
HE	0.455	0.463	0.471	11.56	11.76	11.96
L	0.016	0.020	0.024	0.40	0.50	0.60
L1	-	0.031	-	-	0.80	-
S	-	-	0.036	-	-	0.93
y	-	-	0.004	-	-	0.10
θ	0°	-	5°	0°	-	5°

**Notes:**

1. Dimension D&E do not include interlead flash.
2. Dimension B does not include dambar protrusion/intrusion.
3. Dimension S includes end flash.

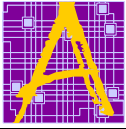

**Package Information**

**48LD CSP ( 6 x 8 mm ) Outline Dimensions  
(48TFBGA)**

unit: mm

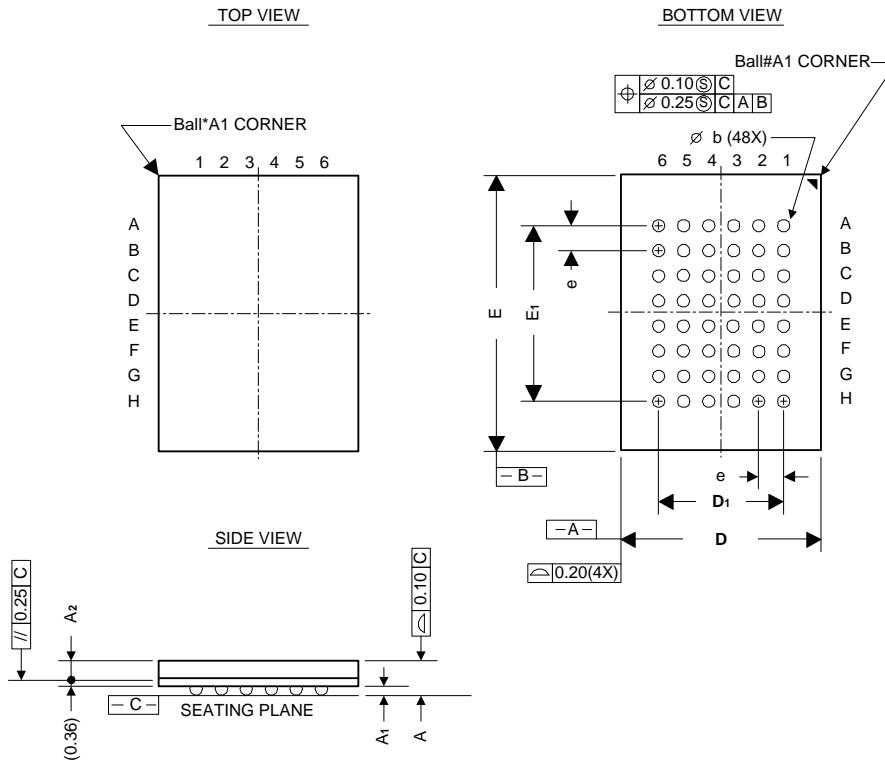

Symbol	Dimensions in mm		
	MIN.	NOM.	MAX.
A	1.04	1.14	1.24
A <sub>1</sub>	0.20	0.25	0.30
A <sub>2</sub>	0.48	0.53	0.58
D	5.90	6.00	6.10
E	7.90	8.00	8.10
D <sub>1</sub>	---	3.75	---
E <sub>1</sub>	---	5.25	---
e	---	0.75	---
b	0.30	0.35	0.40

**Note:**

1. THE BALL DIAMETER, BALL PITCH, STAND-OFF & PACKAGE THICKNESS ARE DIFFERENT FROM JEDEC SPEC MO192 (LOW PROFILE BGA FAMILY).
2. PRIMARY DATUM C AND SEATING PLANE ARE DEFINED BY THE SPHERICAL CROWNS OF THE SOLDER BALLS.
3. DIMENSION b IS MEASURED AT THE MAXIMUM.  
THERE SHALL BE A MINIMUM CLEARANCE OF 0.25mm BETWEEN THE EDGE OF THE SOLDER BALL AND THE BODY EDGE.
4. BALL PAD OPENING OF SUBSTRATE IS  $\Phi$  0.3mm (SMD)  
SUGGEST TO DESIGN THE PCB LAND SIZE AS  $\Phi$  0.3mm (NSMD)