

# 2803 THRU 2824

## HIGH-VOLTAGE, HIGH-CURRENT DARLINGTON ARRAYS

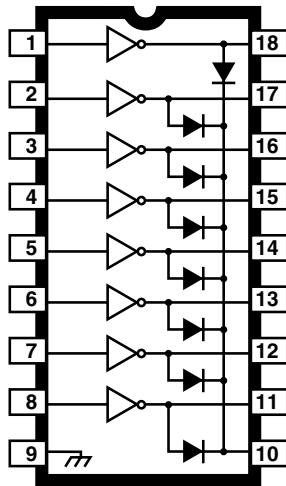

Dwg. No. A-10,322A

Note that the ULx28xxA series (dual in-line package) and ULx28xxLW series (small-outline IC package) are electrically identical and share a common terminal number assignment.

### ABSOLUTE MAXIMUM RATINGS

Output Voltage, $V_{CE}$	
(x2803x and x2804x) .....	50 V
(x2823x and x2824x) .....	95 V
Input Voltage, $V_{IN}$ .....	30 V
Continuous Output Current, $I_C$ ....	500 mA
Continuous Input Current, $I_{IN}$ .....	25 mA
Power Dissipation, $P_D$	
(one Darlington pair) .....	1.0 W
(total package) .....	See Graph
Operating Temperature Range, $T_A$	
Prefix 'ULN' .....	-20°C to +85°C
Prefix 'ULQ' .....	-40°C to +85°C
Storage Temperature Range,	
$T_S$ .....	-55°C to +150°C

Featuring continuous load current ratings to 500 mA for each of the drivers, the Series ULN28xxA/LW and ULQ28xxA/LW high-voltage, high-current Darlington arrays are ideally suited for interfacing between low-level logic circuitry and multiple peripheral power loads. Typical power loads totaling over 260 W (350 mA x 8, 95 V) can be controlled at an appropriate duty cycle depending on ambient temperature and number of drivers turned on simultaneously. Typical loads include relays, solenoids, stepping motors, magnetic print hammers, multiplexed LED and incandescent displays, and heaters. All devices feature open-collector outputs with integral clamp diodes.

The ULx2803A, ULx2803LW, ULx2823A, and ULN2823LW have series input resistors selected for operation directly with 5 V TTL or CMOS. These devices will handle numerous interface needs — particularly those beyond the capabilities of standard logic buffers.

The ULx2804A, ULx2804LW, ULx2824A, and ULN2824LW have series input resistors for operation directly from 6 V to 15 V CMOS or PMOS logic outputs.

The ULx2803A/LW and ULx2804A/LW are the standard Darlington arrays. The outputs are capable of sinking 500 mA and will withstand at least 50 V in the off state. Outputs may be paralleled for higher load current capability. The ULx2823A/LW and ULx2824A/LW will withstand 95 V in the off state.

These Darlington arrays are furnished in 18-pin dual in-line plastic packages (suffix 'A') or 18-lead small-outline plastic packages (suffix 'LW'). All devices are pinned with outputs opposite inputs to facilitate ease of circuit board layout. Prefix 'ULN' devices are rated for operation over the temperature range of -20°C to +85°C; prefix 'ULQ' devices are rated for operation to -40°C.

### FEATURES

- TTL, DTL, PMOS, or CMOS Compatible Inputs
- Output Current to 500 mA
- Output Voltage to 95 V
- Transient-Protected Outputs
- Dual In-Line Package or Wide-Body Small-Outline Package

x = Character to identify specific device. Characteristic shown applies to family of devices with remaining digits as shown. See matrix on next page.

**2803 THRU 2824  
HIGH-VOLTAGE,  
HIGH-CURRENT  
DARLINGTON ARRAYS**

**DEVICE PART NUMBER DESIGNATION**

$V_{CE(MAX)}$	50 V	95 V
$I_{C(MAX)}$	500 mA	500 mA
<b>Logic</b>	<b>Part Number</b>	
5V TTL, CMOS	ULN2803A* ULN2803LW*	ULN2823A* ULN2823LW
6-15 V CMOS, PMOS	ULN2804A* ULN2804LW*	ULN2824A* ULN2824LW

\* Also available for operation between -40°C and +85°C. To order, change prefix from 'ULN' to 'ULQ'.

**PARTIAL SCHEMATICS**

**ULx28x3A/LW (Each Driver)**

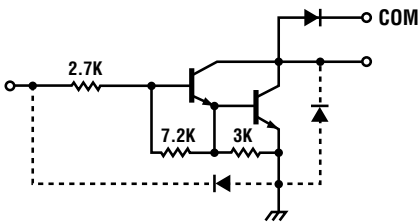

Dwg. No. A-9651

**ULx28x4A/LW (Each Driver)**

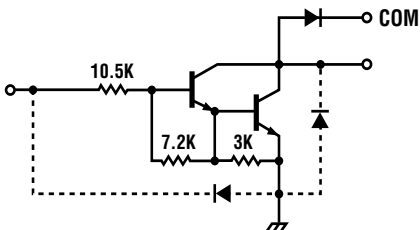

Dwg. No. A-9898A

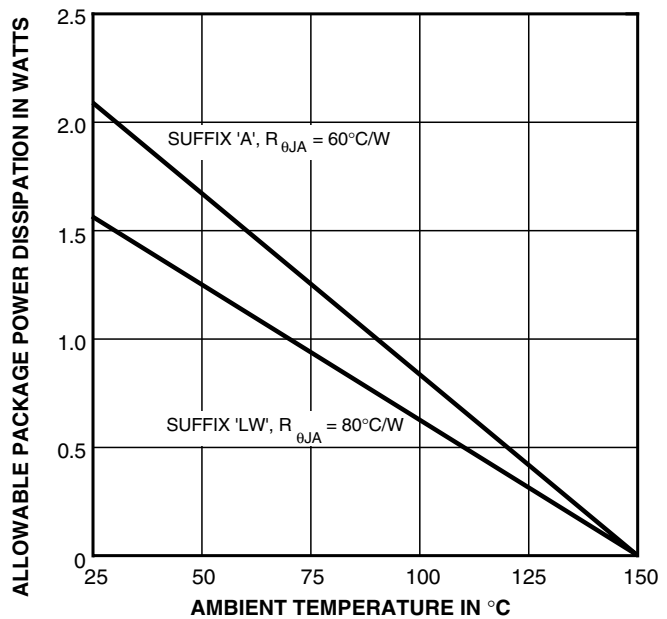

Dwg. GP-018B

x = Character to identify specific device. Specification shown applies to family of devices with remaining digits as shown. See matrix above.



**2803 THRU 2824  
HIGH-VOLTAGE,  
HIGH-CURRENT  
DARLINGTON ARRAYS**

**Types ULx2803A, ULx2803LW, ULx2804A, and ULx2804LW  
ELECTRICAL CHARACTERISTICS at +25°C (unless otherwise noted).**

Characteristic	Symbol	Test Fig.	Applicable Devices	Test Conditions	Limits			
					Min.	Typ.	Max.	Units
Output Leakage Current	$I_{CEX}$	1A	All	$V_{CE} = 50\text{ V}, T_A = 25^\circ\text{C}$	—	< 1	50	$\mu\text{A}$
				$V_{CE} = 50\text{ V}, T_A = 70^\circ\text{C}$	—	< 1	100	$\mu\text{A}$
		1B	ULx2804x	$V_{CE} = 50\text{ V}, T_A = 70^\circ\text{C}, V_{IN} = 1.0\text{ V}$	—	< 5	500	$\mu\text{A}$
Collector-Emitter Saturation Voltage	$V_{CE(SAT)}$	2	All	$I_C = 100\text{ mA}, I_B = 250\text{ }\mu\text{A}$	—	0.9	1.1	V
				$I_C = 200\text{ mA}, I_B = 350\text{ }\mu\text{A}$	—	1.1	1.3	V
				$I_C = 350\text{ mA}, I_B = 500\text{ }\mu\text{A}$	—	1.3	1.6	V
Input Current	$I_{IN(ON)}$	3	ULx2803x	$V_{IN} = 3.85\text{ V}$	—	0.93	1.35	mA
			ULx2804x	$V_{IN} = 5.0\text{ V}$	—	0.35	0.5	mA
				$V_{IN} = 12\text{ V}$	—	1.0	1.45	mA
	$I_{IN(OFF)}$	4	All	$I_C = 500\text{ }\mu\text{A}, T_A = 70^\circ\text{C}$	50	65	—	$\mu\text{A}$
Input Voltage	$V_{IN(ON)}$	5	ULx2803x	$V_{CE} = 2.0\text{ V}, I_C = 200\text{ mA}$	—	—	2.4	V
				$V_{CE} = 2.0\text{ V}, I_C = 250\text{ mA}$	—	—	2.7	V
				$V_{CE} = 2.0\text{ V}, I_C = 300\text{ mA}$	—	—	3.0	V
		ULx2804x	$V_{CE} = 2.0\text{ V}, I_C = 125\text{ mA}$	—	—	5.0	V	
			$V_{CE} = 2.0\text{ V}, I_C = 200\text{ mA}$	—	—	6.0	V	
			$V_{CE} = 2.0\text{ V}, I_C = 275\text{ mA}$	—	—	7.0	V	
			$V_{CE} = 2.0\text{ V}, I_C = 350\text{ mA}$	—	—	8.0	V	
Input Capacitance	$C_{IN}$	—	All		—	15	25	pF
Turn-On Delay	$t_{PLH}$	8	All	$0.5 E_{IN}$ to $0.5 E_{OUT}$	—	0.25	1.0	$\mu\text{s}$
Turn-Off Delay	$t_{PHL}$	8	All	$0.5 E_{IN}$ to $0.5 E_{OUT}$	—	0.25	1.0	$\mu\text{s}$
Clamp Diode Leakage Current	$I_R$	6	All	$V_R = 50\text{ V}, T_A = 25^\circ\text{C}$	—	—	50	$\mu\text{A}$
				$V_R = 50\text{ V}, T_A = 70^\circ\text{C}$	—	—	100	$\mu\text{A}$
Clamp Diode Forward Voltage	$V_F$	7	All	$I_F = 350\text{ mA}$	—	1.7	2.0	V

Complete part number includes prefix to operating temperature range: ULN = -20°C to +85°C, ULQ = -40°C to +85°C and a suffix to identify package style: A = DIP, LW = SOIC.

# 2803 THRU 2824 HIGH-VOLTAGE, HIGH-CURRENT DARLINGTON ARRAYS

## Types ULx2823A, ULN2823LW, ULx2824A, and ULN2824LW ELECTRICAL CHARACTERISTICS at +25°C (unless otherwise noted).

Characteristic	Symbol	Test Fig.	Applicable Devices	Test Conditions	Limits			
					Min.	Typ.	Max.	Units
Output Leakage Current	$I_{CEX}$	1A	All	$V_{CE} = 95\text{ V}, T_A = 25^\circ\text{C}$	—	< 1	50	$\mu\text{A}$
				$V_{CE} = 95\text{ V}, T_A = 70^\circ\text{C}$	—	< 1	100	$\mu\text{A}$
		1B	ULx2824x	$V_{CE} = 95\text{ V}, T_A = 70^\circ\text{C}, V_{IN} = 1.0\text{ V}$	—	< 5	500	$\mu\text{A}$
Collector-Emitter Saturation Voltage	$V_{CE(SAT)}$	2	All	$I_C = 100\text{ mA}, I_B = 250\text{ }\mu\text{A}$	—	0.9	1.1	V
				$I_C = 200\text{ mA}, I_B = 350\text{ }\mu\text{A}$	—	1.1	1.3	V
				$I_C = 350\text{ mA}, I_B = 500\text{ }\mu\text{A}$	—	1.3	1.6	V
Input Current	$I_{IN(ON)}$	3	ULx2823x	$V_{IN} = 3.85\text{ V}$	—	0.93	1.35	mA
			ULx2824x	$V_{IN} = 5.0\text{ V}$	—	0.35	0.5	mA
				$V_{IN} = 12\text{ V}$	—	1.0	1.45	mA
	$I_{IN(OFF)}$	4	All	$I_C = 500\text{ }\mu\text{A}, T_A = 70^\circ\text{C}$	50	65	—	$\mu\text{A}$
Input Voltage	$V_{IN(ON)}$	5	ULx2823x	$V_{CE} = 2.0\text{ V}, I_C = 200\text{ mA}$	—	—	2.4	V
				$V_{CE} = 2.0\text{ V}, I_C = 250\text{ mA}$	—	—	2.7	V
				$V_{CE} = 2.0\text{ V}, I_C = 300\text{ mA}$	—	—	3.0	V
			ULx2824x	$V_{CE} = 2.0\text{ V}, I_C = 125\text{ mA}$	—	—	5.0	V
				$V_{CE} = 2.0\text{ V}, I_C = 200\text{ mA}$	—	—	6.0	V
				$V_{CE} = 2.0\text{ V}, I_C = 275\text{ mA}$	—	—	7.0	V
				$V_{CE} = 2.0\text{ V}, I_C = 350\text{ mA}$	—	—	8.0	V
Input Capacitance	$C_{IN}$	—	All		—	15	25	pF
Turn-On Delay	$t_{PLH}$	8	All	$0.5 E_{IN}$ to $0.5 E_{OUT}$	—	0.25	1.0	$\mu\text{s}$
Turn-Off Delay	$t_{PHL}$	8	All	$0.5 E_{IN}$ to $0.5 E_{OUT}$	—	0.25	1.0	$\mu\text{s}$
Clamp Diode Leakage Current	$I_R$	6	All	$V_R = 95\text{ V}, T_A = 25^\circ\text{C}$	—	—	50	$\mu\text{A}$
				$V_R = 95\text{ V}, T_A = 70^\circ\text{C}$	—	—	100	$\mu\text{A}$
Clamp Diode Forward Voltage	$V_F$	7	All	$I_F = 350\text{ mA}$	—	1.7	2.0	V

Complete part number includes prefix to operating temperature range: ULN = -20°C to +85°C, ULQ = -40°C to +85°C and a suffix to identify package style: A = DIP, LW = SOIC. Note that the ULQ2823LW and ULQ2824LW are not presently available.



# 2803 THRU 2824 HIGH-VOLTAGE, HIGH-CURRENT DARLINGTON ARRAYS

## TEST FIGURES

FIGURE 1A

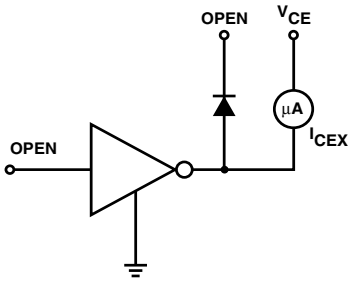

Dwg. No. A-9729A

FIGURE 1B

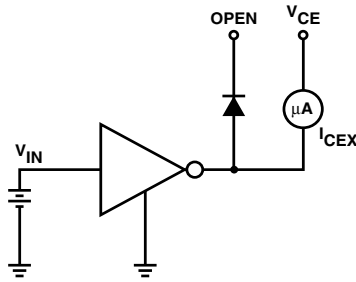

Dwg. No. A-9730A

FIGURE 2

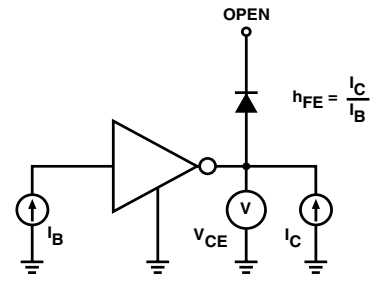

Dwg. No. A-9731A

FIGURE 3

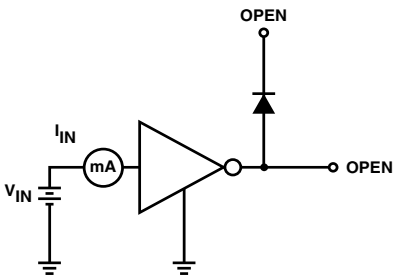

Dwg. No. A-9732A

FIGURE 4

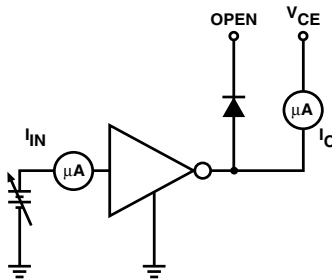

Dwg. No. A-9733A

FIGURE 5

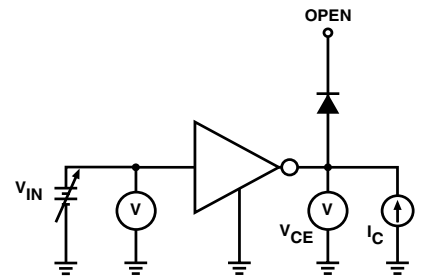

Dwg. No. A-9734A

FIGURE 6

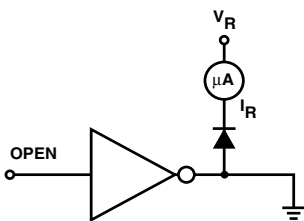

Dwg. No. A-9735A

FIGURE 7

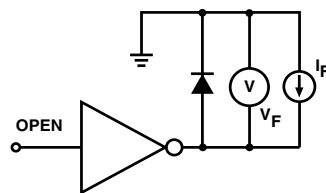

Dwg. No. A-9736A

FIGURE 8

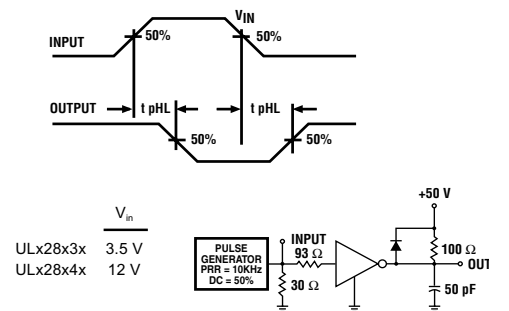

# 2803 THRU 2824 HIGH-VOLTAGE, HIGH-CURRENT DARLINGTON ARRAYS

**ALLOWABLE COLLECTOR CURRENT  
AS A FUNCTION OF DUTY CYCLE**  
ULx28xxA

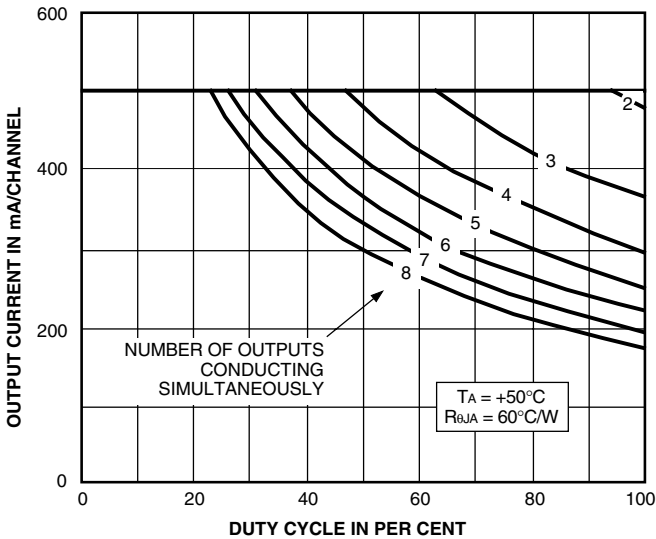

Dwg. GP-070-2

**ALLOWABLE COLLECTOR CURRENT  
AS A FUNCTION OF DUTY CYCLE**  
ULx28xxLW

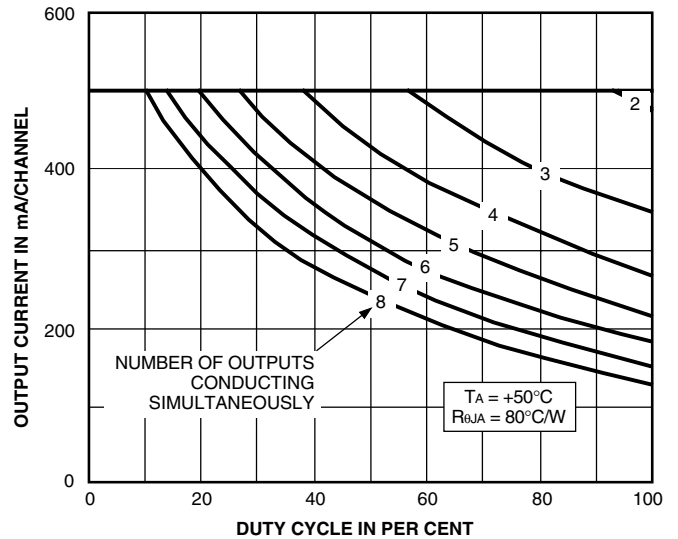

Dwg. GP-070-4

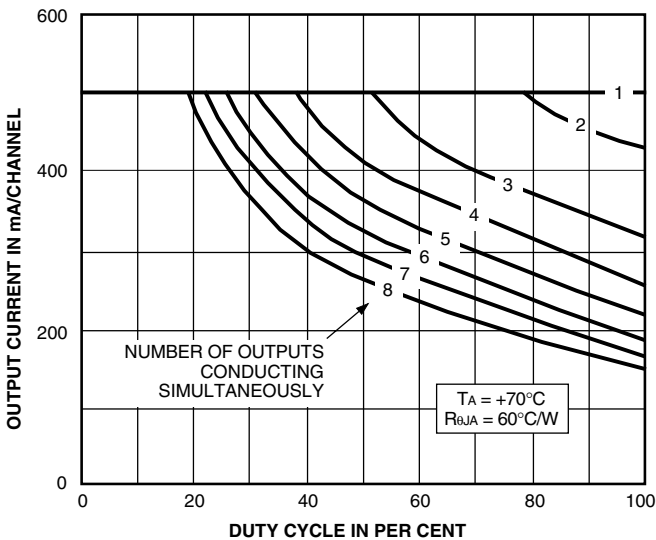

Dwg. GP-070-1

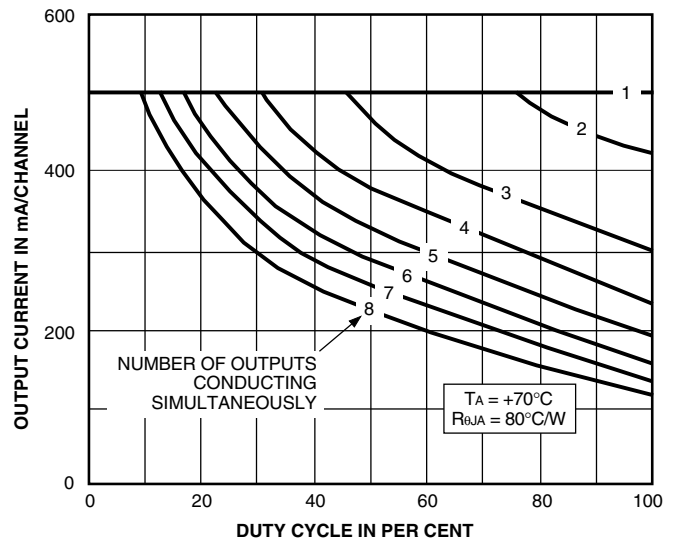

Dwg. GP-070-3

x = Characters to identify specific device. Specification shown applies to family of devices with remaining digits as shown.



115 Northeast Cutoff, Box 15036  
Worcester, Massachusetts 01615-0036 (508) 853-5000

# 2803 THRU 2824 HIGH-VOLTAGE, HIGH-CURRENT DARLINGTON ARRAYS

**INPUT CURRENT AS A  
FUNCTION OF INPUT VOLTAGE**  
ULx28x3x

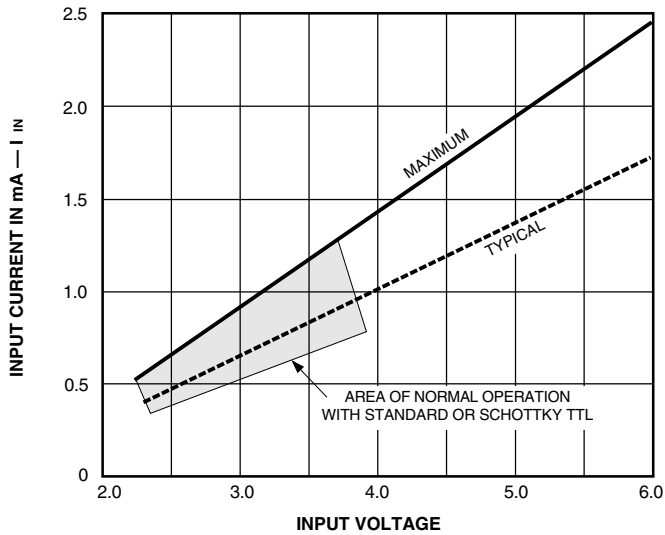

Dwg. GP-069

**SATURATION VOLTAGE AS A FUNCTION OF  
COLLECTOR CURRENT**

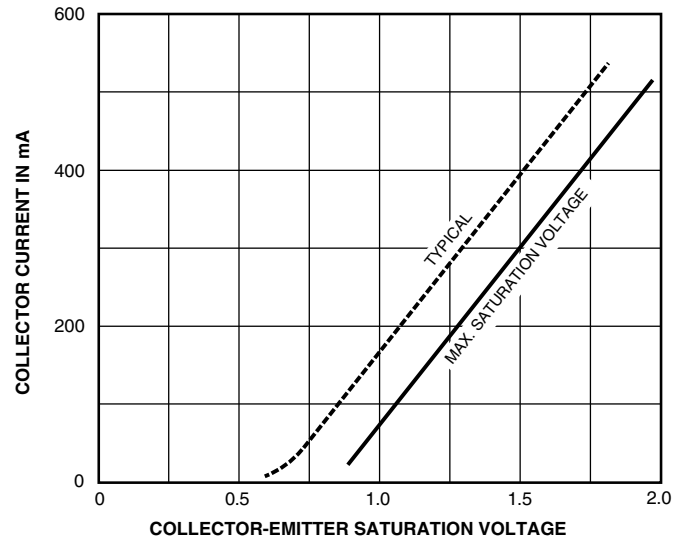

Dwg. GP-067

ULx28x4x

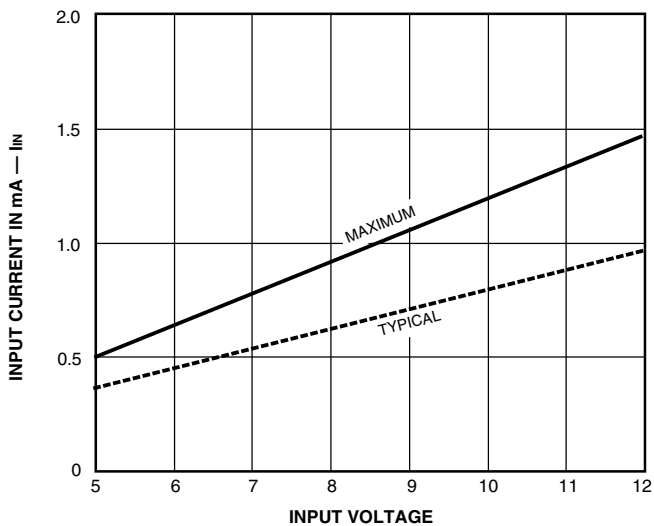

Dwg. GP-069-1

**COLLECTOR CURRENT AS A  
FUNCTION OF INPUT CURRENT**

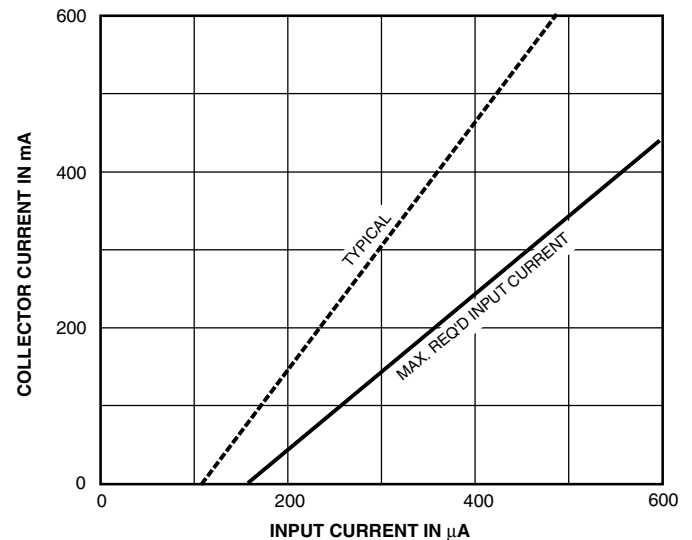

Dwg. GP-068

x = Characters to identify specific device. Characteristic shown applies to family of devices with remaining digits as shown.

**2803 THRU 2824  
HIGH-VOLTAGE,  
HIGH-CURRENT  
DARLINGTON ARRAYS**

**PACKAGE DESIGNATOR "A" DIMENSIONS**

Dimensions in Inches  
(controlling dimensions)

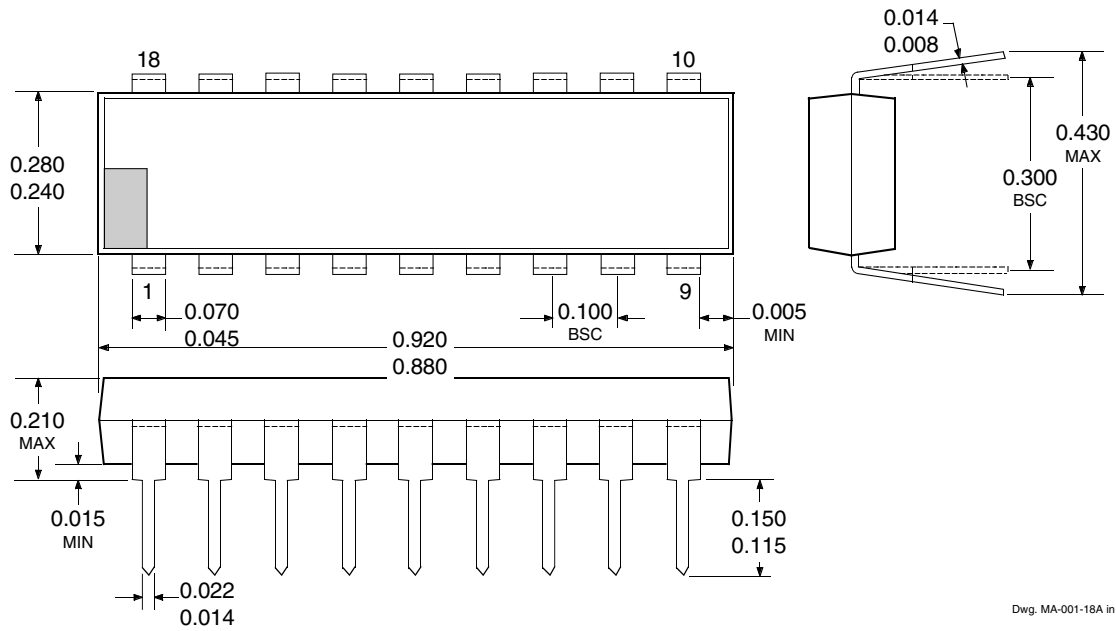

Dimensions in Millimeters  
(for reference only)

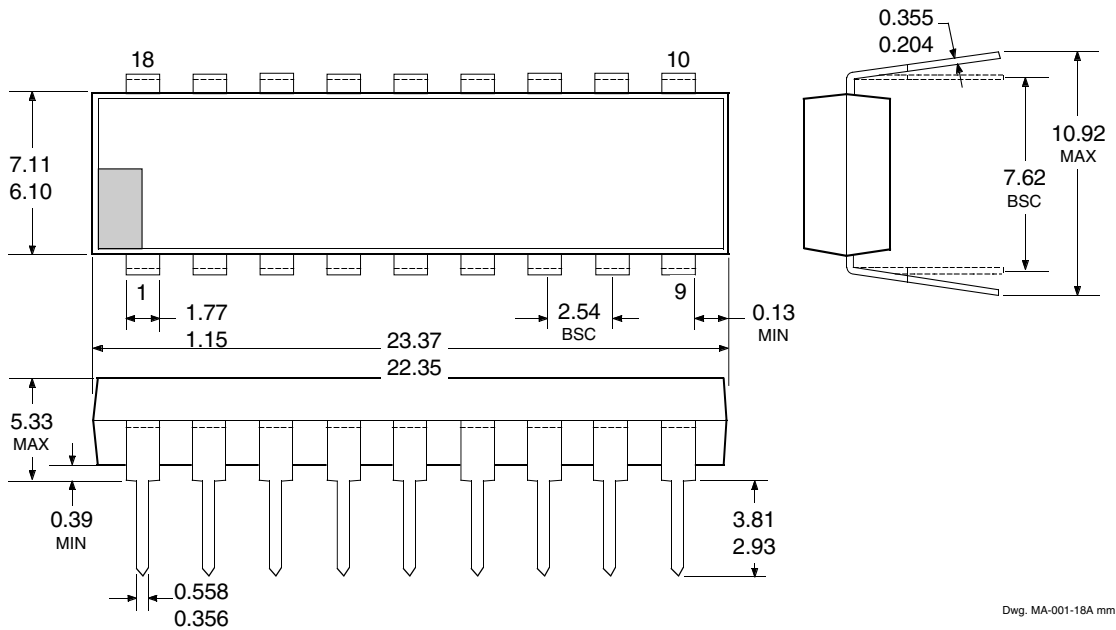

- NOTES: 1. Exact body and lead configuration at vendor's option within limits shown.  
2. Lead spacing tolerance is non-cumulative.  
3. Lead thickness is measured at seating plane or below.



115 Northeast Cutoff, Box 15036  
Worcester, Massachusetts 01615-0036 (508) 853-5000



# 2803 THRU 2824 HIGH-VOLTAGE, HIGH-CURRENT DARLINGTON ARRAYS

## PACKAGE DESIGNATOR "LW" DIMENSIONS

Dimensions in Inches  
(for reference only)

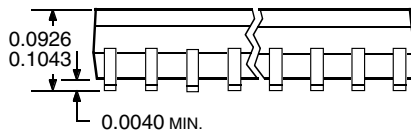
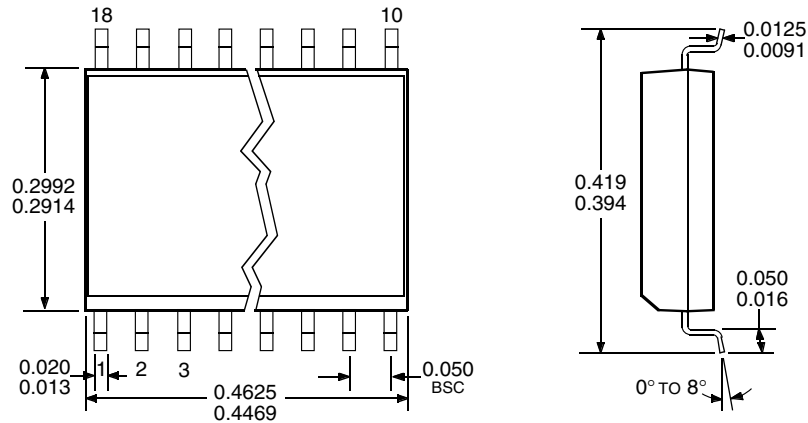

Dwg. MA-008-18A in

Dimensions in Millimeters  
(controlling dimensions)

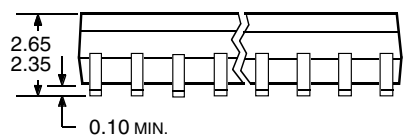
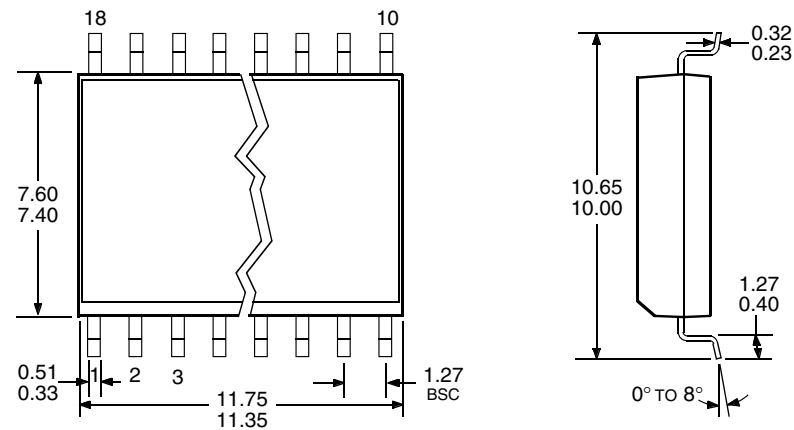

Dwg. MA-008-18A mm

- NOTES: 1. Exact body and lead configuration at vendor's option within limits shown.  
2. Lead spacing tolerance is non-cumulative.

**2803 THRU 2824  
HIGH-VOLTAGE,  
HIGH-CURRENT  
DARLINGTON ARRAYS**

*The products described here are manufactured under one or more U.S. patents or U.S. patents pending.*

*Allegro MicroSystems, Inc. reserves the right to make, from time to time, such departures from the detail specifications as may be required to permit improvements in the performance, reliability, or manufacturability of its products. Before placing an order, the user is cautioned to verify that the information being relied upon is current.*

*Allegro products are not authorized for use as critical components in life-support devices or systems without express written approval.*

*The information included herein is believed to be accurate and reliable. However, Allegro MicroSystems, Inc. assumes no responsibility for its use; nor for any infringement of patents or other rights of third parties which may result from its use.*



115 Northeast Cutoff, Box 15036  
Worcester, Massachusetts 01615-0036 (508) 853-5000