



Multi-Standard CMOS Single Chip Telephone IC with Dual Soft Clipping

Key Features

- ❑ Line/speech circuit, LD/MF repertory dialler and tone ringer on one 28 pin CMOS chip
- ❑ Operating range from 13 to 100 mA (down to 5 mA with reduced performance)
- ❑ Soft clipping to avoid harsh distortion
- ❑ Volume control of receive signal
- ❑ Line loss compensation selectable by pin option
- ❑ Low noise (max. - 72 dBmp)
- ❑ Real or complex impedance
- ❑ NET 4 compatible
- ❑ LD/MF switchable dialling
- ❑ Pacifier tone during programming
- ❑ 31 digit last number redial
- ❑ Repertory memories (not AS2534), 4 direct/10 indirect (AS2533/6), 12 direct (AS2535)
- ❑ Repeat dialling by busy or engaged (not AS2535)
- ❑ Sliding cursor protocol with comparison
- ❑ Pause key for access pause or wait function
- ❑ 3 flash keys, 100 ms, 280 ms and 375/600 ms
- ❑ On chip MF filter (CEPT CS 203 compatible)
- ❑ Ring frequency discrimination
- ❑ 3-tone melody generator

Block Diagramme

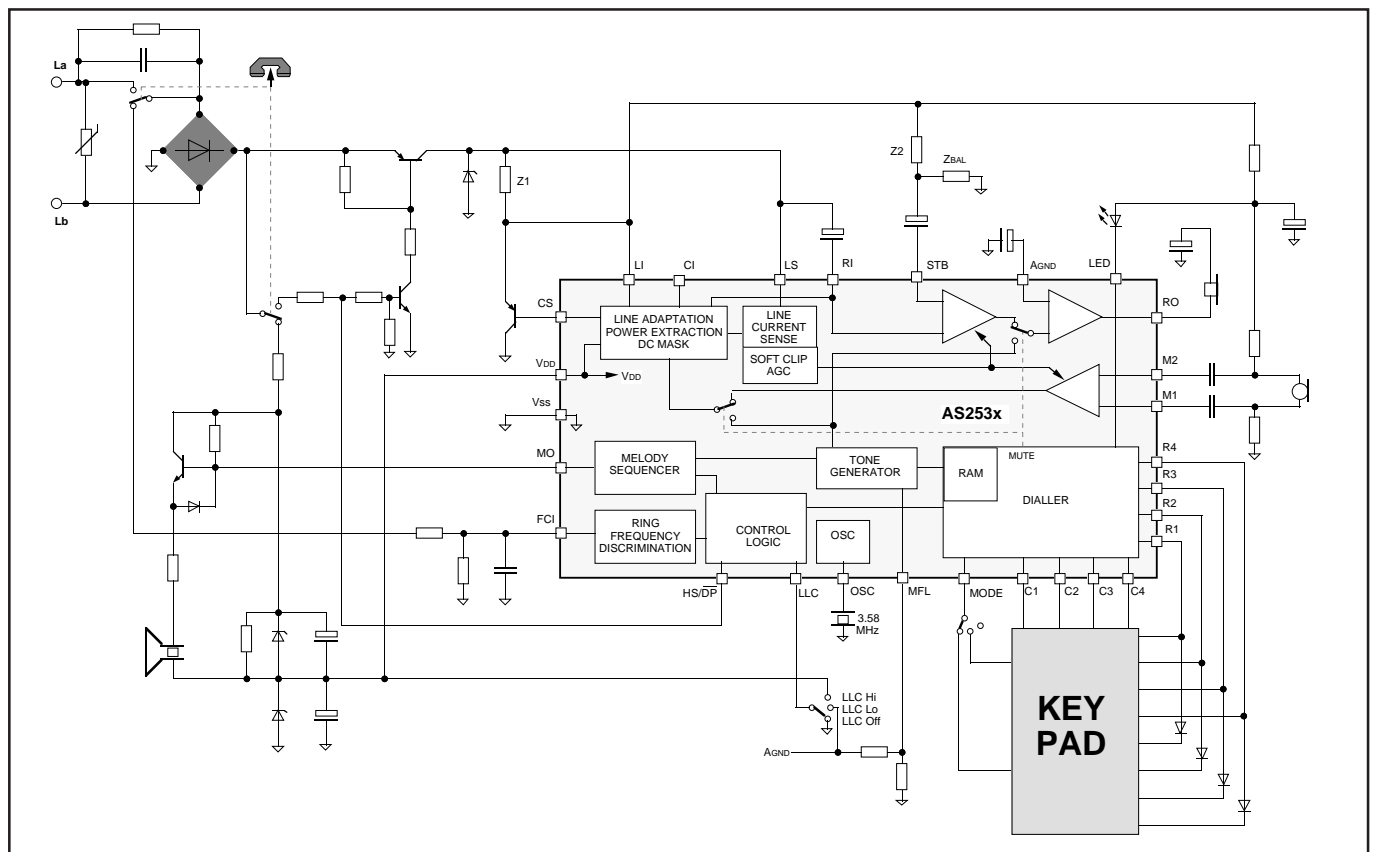

General Description

The AS253x is a CMOS integrated circuit that contains all the functions needed to form a high performance electronic telephone.

The device incorporates LD/MF repertory dialling, melody generation, ring frequency discrimination and a high quality line/speech circuit.

A RAM is on chip for a 31 digit last number redial and memories (not AS2534) each containing up to 21 digits/data. The sliding cursor procedure makes the LNR function easy to use under various PABX systems. Also centrex keys (not AS2535) are provided.

The device incorporate a volume control for the earpiece. The volume can be controlled by the VOL key (+ 5.4 dB) or by the -/+ keys (+8.1 dB/-5.4 dB in 5 steps).

The versatility of the circuit is provided by pin options and a few external components. This allows easy adaptation to different PTT requirements.

Package

Available in 28 pin SOIC or DIP.

Pin Description

Pin #	Symbol	Function
23 24	M1 M2	Microphone Inputs Differential inputs for the microphone (electret).
3	RO	Receive Output This is the output for driving a dynamic earpiece with an impedance of 140 to 300 Ω .
5	A _{GND}	Analogue Ground This is the analogue ground for the amplifiers.
28	RI	Receive Input This is the input for the receive signal.
6	STB	Side Tone Balance Input This is the input for side tone cancellation.
1	LS	Line Current Sense Input This is the input for sensing the line current.
27	LI	Line Input This input is used for power extraction and line current sensing.
25	CS	Current Shunt Control Output This N-channel open drain output controls the external high power shunt transistor for the modulation of the line voltage and for shorting the line during make period of pulse dialling.
4	V _{DD}	Positive Voltage Supply This is the supply pin for the circuit.
26	V _{SS}	Negative Power Supply
8	MO	Melody Output PDM output of the melody generator for tone ringing. Hi-Z when not active.
21	FCI	Frequency Comparator Input This is a Schmitt trigger input for ring frequency discrimination. Disabled during off-hook.
10	HS/DP	Hook Switch Input and Dial Pulse Output This is an I/O that is pulled high by the hook switch when off-hook and an open drain pulls it low during break periods of pulse dialling and flash.
11	OSC	Oscillator Input Pin for ceramic resonator (3.58 MHz). Recommended: Murata CSA 3.58MG312AM.
9	LLC	Line Loss Compensation Select pin for line loss compensation (see also figure 4 to 7). LLC = A _{GND} : 20 - 50 mA LLC = V _{DD} : 45 - 75 mA LLC = V _{SS} : none.
22	LED	LED Output Driver Output for driving an LED that will be flashing when in Programme/Mute state.

Continues...

Pin Description cont'd

Pin #	Symbol	Function																		
12	MODE	<p>Signalling Mode Select Input</p> <table border="1"> <thead> <tr> <th>Mode pin</th> <th>Function</th> </tr> </thead> <tbody> <tr> <td>Open</td> <td>Dialling inhibited</td> </tr> <tr> <td>Row 1</td> <td>LD mode, 10 pps, 33/66 ms</td> </tr> <tr> <td>Row 2</td> <td>LD mode, 10 pps, 40/60 ms</td> </tr> <tr> <td>Row 3</td> <td>LD mode, 20 pps, 33/66 ms</td> </tr> <tr> <td>Row 4</td> <td>LD mode, 20 pps, 40/60 ms</td> </tr> <tr> <td>Row 5</td> <td>LD mode, 10 pps, 33/66 ms, Temp. MF with tone on first * key entry</td> </tr> <tr> <td>Row 6</td> <td>MF only, 82/82 ms</td> </tr> <tr> <td>Row 7</td> <td>MF only, 82/160 ms</td> </tr> </tbody> </table> <p>During temporary MF: 82/160 ms</p>	Mode pin	Function	Open	Dialling inhibited	Row 1	LD mode, 10 pps, 33/66 ms	Row 2	LD mode, 10 pps, 40/60 ms	Row 3	LD mode, 20 pps, 33/66 ms	Row 4	LD mode, 20 pps, 40/60 ms	Row 5	LD mode, 10 pps, 33/66 ms, Temp. MF with tone on first * key entry	Row 6	MF only, 82/82 ms	Row 7	MF only, 82/160 ms
Mode pin	Function																			
Open	Dialling inhibited																			
Row 1	LD mode, 10 pps, 33/66 ms																			
Row 2	LD mode, 10 pps, 40/60 ms																			
Row 3	LD mode, 20 pps, 33/66 ms																			
Row 4	LD mode, 20 pps, 40/60 ms																			
Row 5	LD mode, 10 pps, 33/66 ms, Temp. MF with tone on first * key entry																			
Row 6	MF only, 82/82 ms																			
Row 7	MF only, 82/160 ms																			
20 19 18 17	R1 R2 R3 R4	<p>Keyboard Rows (see key arrangement in figure 2)</p>																		
16 15 14 13	C1 C2 C3 C4	<p>Keyboard Columns (see key arrangement in figure 2)</p>																		
7	CI	<p>Complex Impedance Pin For complex impedance a capacitor should be connected to this pin.</p>																		
2	MFL	<p>MF Level Setting A voltage divider connected from this pin to A_{GND} and V_{SS} can be used to set the DTMF level.</p>																		

Selection Overview

Function	AS2533	AS2534B	AS2534E	AS2535	AS2536
Direct memories (one-key)	4	0	0	12	4
Indirect memories (two-key)	10	0	0	0	10
Repeat dialling	yes	yes	yes	no	yes
LNR key	yes	yes	yes	yes	yes
Pause insertion by LNR key	yes	yes	yes	yes	yes
Pause (PS) key	yes	yes	yes	no	yes
P/M or MT key	P/M	P/M	MT	P/M	P/M
Tone/Pulse (T/P) key	yes	yes	yes	no	yes
Temperary MF by * key	yes	yes	yes	yes	yes
Centrex (A - D) keys	yes	yes	yes	no	yes
Volume (VOL, -/+) keys	yes	yes	yes	yes	yes
Volume reset by off-hook	yes	no	no	yes	no
Programming of tone ringer	yes	yes	no	yes	yes
R3 Flash duration	600 ms	600 ms	375 ms	600 ms	600 ms

Keyboard Connections

(Either VOL or +/- keys)

Key closure, R_{ON} max. = 1 kohm
 Key open, R_{OFF} min. = 1 Mohm

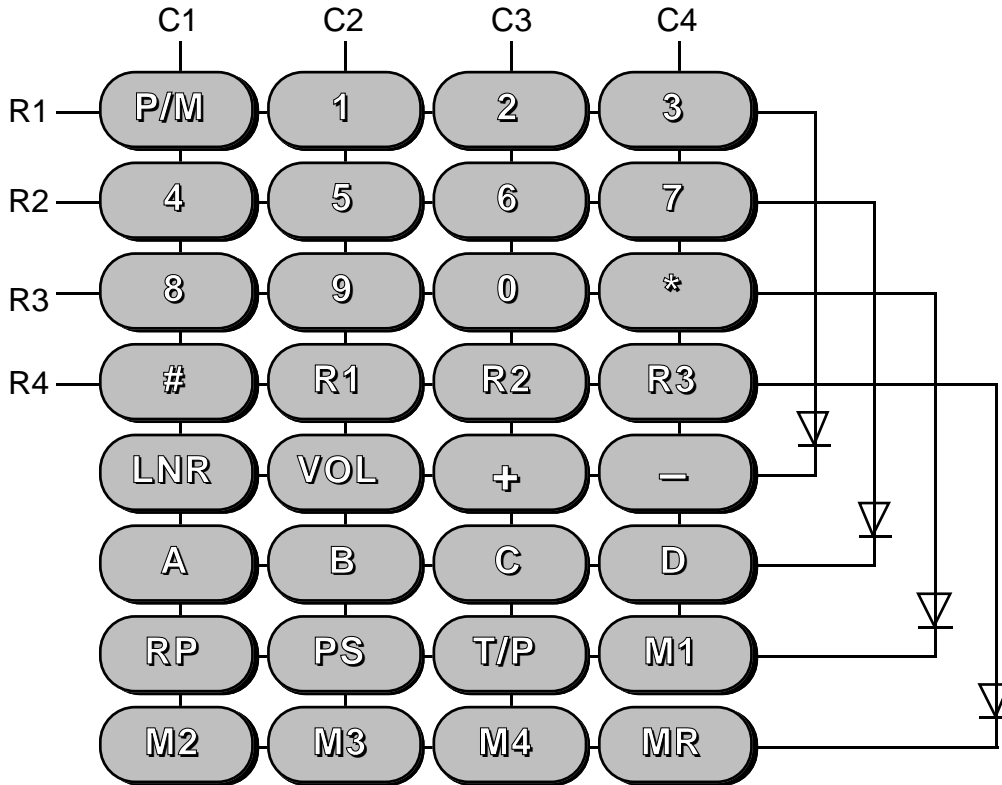

Figure 2a (AS2533/6)

For AS2534E
 P/M is MT key.

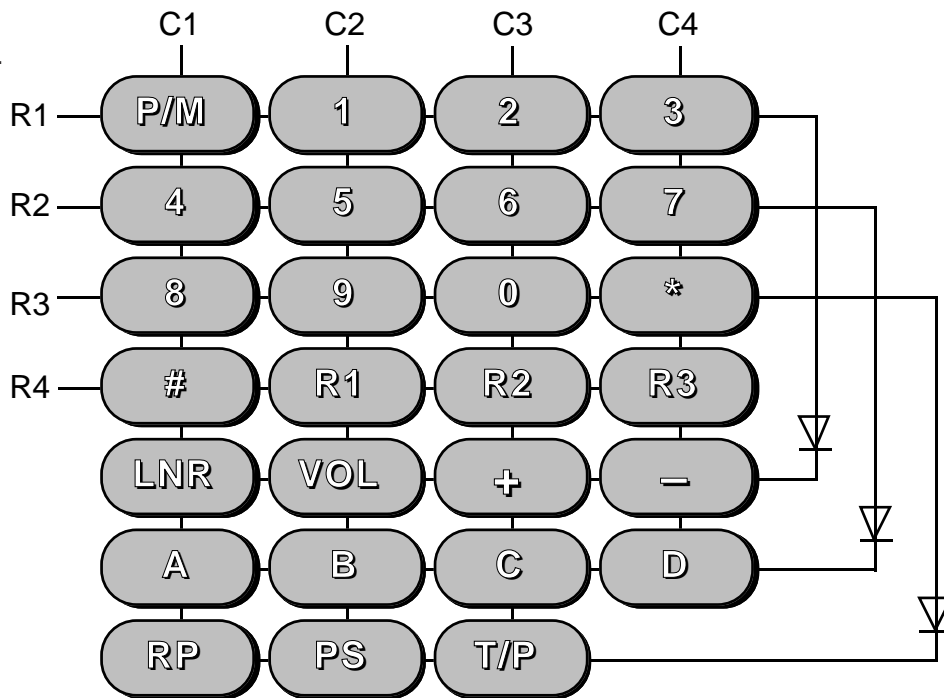

Figure 2b (AS2534)

Keyboard Connections Continued

(Either VOL or +/- keys)

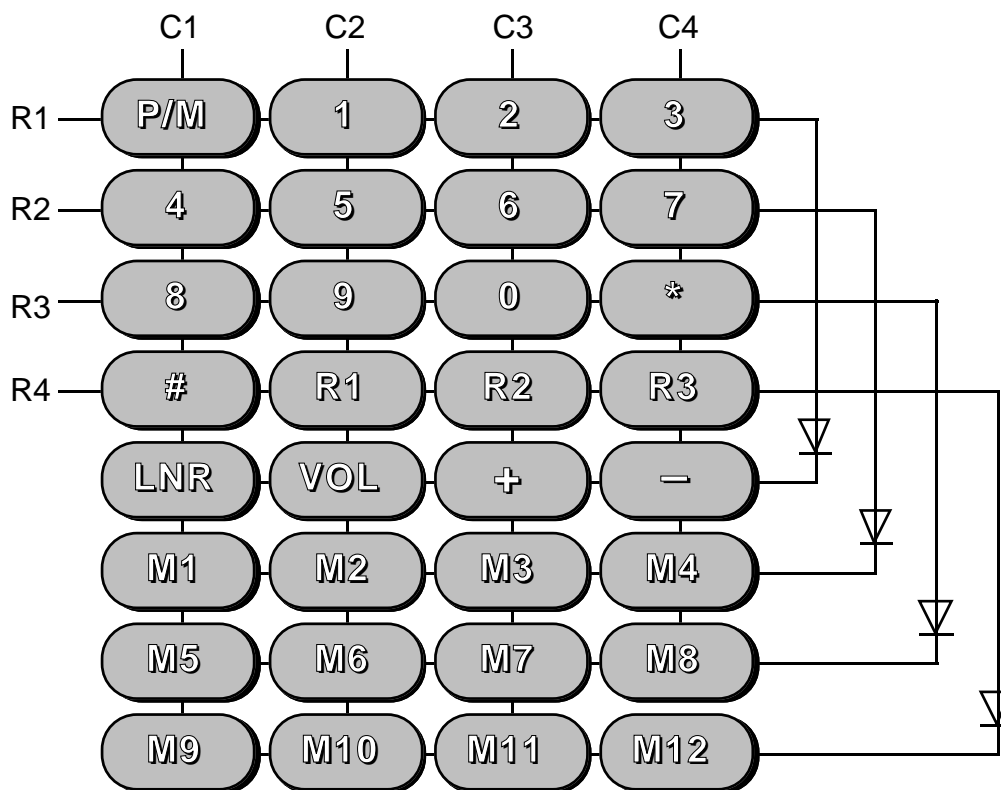

Figure 2c (AS2535)

Power On Reset

The on chip power on reset circuit monitors the supply voltage (V_{DD}) during off-hook. When V_{DD} rises above approx. 1.2V, a power on reset occurs which clears the RAM.

DC Conditions

The normal operating range is from 13 mA to 100 mA. Operating range with reduced performance is from 5 mA to 13 mA (parallel operation). In the operating range all functions are operational.

At line currents below 13 mA the AS253x provides an additional slope below 4.5V in order to allow parallel operation (see figure 13).

The dc characteristic (excluding diode bridge) is determined by the voltage at LI and the resistor R1 at line currents above 13 mA as follows:

$$V_{LS} = V_{LI} + I_{LINE} \cdot R1$$

The voltage at LI is 4.5V in the normal operating range.

During pulse dialling the speech circuit and other part of

the device not operating is in a power down mode to save current. The CS pin is pulled to V_{SS} in order to turn the external shunt transistor on to keep a low voltage drop at the LS pin during make periods.

AC Impedance

The ac impedance of the circuit is set by external components. The impedance can be real or complex. The ac impedance is determined as follows:

$$Z_{AC} = 33 \cdot Z1$$

The dc value of Z1 should be 30 Ω to maintain correct dc performance.

Return loss and side tone cancellation can be determined independent of each other.

Speech Circuit

The speech circuit consists of a transmit and a receive path with dual soft clipping, mute, line loss compensation and sidetone cancellation.

Transmit

The gain of the transmit path is 37 dB for 600 Ω line termination from M1/M2 to LS (see test circuit figure 10).

The microphone input is differential with an input impedance of 20 k Ω .

The soft clip circuit limits the output voltage at LI to $2V_{PEAK}$ (see figure 12). The attack time is 30 μ s/6 dB and the decay time is 20 ms/6 dB. When mute is active, during dialling or after pressing the **P/M** key, the gain is reduced by > 60 dB.

Receive

The gain of the receive path is 3 dB for 600 Ω line termination (test circuit figure 10). The receive input is the differential signal of R1 and STB. When mute is active during dialling the gain is reduced by > 60 dB. During DTMF dialling a MF comfort tone is applied to the receiver. The comfort tone is the DTMF signal with a level that is -30 dB relative to the line signal.

The receive gain can be changed by pressing the volume keys. The **VOL** key gives a +5.4 dB boost and has a toggle function, i.e. repressing the key resets the gain to default. As an alternative the **+/-** keys can be used. The **+** key increases the gain by 8.1 dB in 3 steps and the **-** key decreases the gain by 5.4 dB in 2 steps (total range 13.5 dB). On AS2533/5 the volume is reset to default by next off-hook and on AS2534/6 the volume setting will remain at last setting. A POR will always reset the volume to default.

The soft clip circuit limits the voltage at the receive output (RO) to $1V_{PEAK}$ (see figure 11). It prevents harsh distortion and acoustic shock.

Sidetone

A good sidetone cancellation is achieved by using the following equation:

$$\frac{Z_{BAL}}{Z_{LINE}} = \frac{Z_2}{Z_1}$$

The sidetone cancellation signal is applied to the STB input.

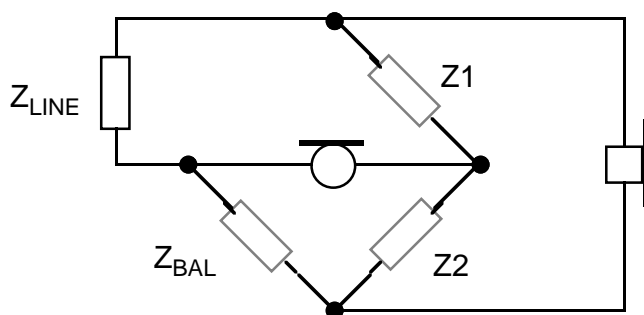

Figure 3
Side Tone Balance

Line Loss Compensation

The line loss compensation is a pin option. When it is activated, the transmit and receive gains are decreased by 6 dB at line currents from 20 to 50 mA when LLC = A_{GND} and 45 to 75 mA when LLC = high (@ $R1 = 30 \Omega$). The line loss compensation is disabled when LLC = low (see figure 4 and 5).

Dialling Functions

Valid Keys

The key scanning is enabled when HS/DPN is pulled high and V_{DD} is above V_{REF} . A valid key is detected from the keyboard by connecting the appropriate row to the column ($R_{ON} < 1 \text{ k}\Omega$). This can be done using an $n \times m$ keyboard matrix with single contacts. Four diodes are used to extend the number of rows (see keyboard arrangement fig. 2). It is also possible to connect a μ controller to the rows and columns (see application note AN3010).

P/M and MT Key

The **P/M** key (not AS2534E) is used to enter the Programme/Mute state and the **MT** key for muting (AS2534E only). Depressing the **P/M** key mutes the speech circuit and the device is in programme state. Repressing the **P/M** key deactivates the mute and programme state (toggle function). The **MT** key works in a similar way, but has no programme function.

When programme/mute is activated, the LED indication is turned on (flashing: 80 ms 'on' and 1 sec 'off').

Dial Mode Selection

The default mode (LD or MF) can be selected by the mode pin. When default LD mode is selected, a temporary change to MF can be invoked by pressing **T/P** key (not AS2535) or the * key (when mode pin = row 5, the MF tone is generated with the first * key entry). The circuit will revert to LD by repressing the **T/P** key (not AS2535) or by pressing the **R** (**R1**, **R2** or **R3**) key or by next on-hook.

When MF mode is selected by the mode pin, the circuit can not be changed temporary to LD but will remain in MF mode.

Centrex Keys (not AS2535)

The alphameric keys accommodate easy use of centrex services. The A, B, C and D keys are only valid in MF mode (including temporary MF) and are not storable. Pressing one of these keys will invoke the appropriate MF tones to be transmitted.

The centrex keys are not stored in the RAM, and subsequently entered digits are buffered in FIFO.

Last Number Redial

LNR is a facility that allows resignalling of the last manually dialled number without keying in all the digits again. The LNR is repeatable after each off-hook.

The current content of the RAM is overwritten by new entries.

A manually entered number is automatically stored in the LNR RAM. The capacity of the RAM is 31 digits. If a number greater than 31 digits is entered, the LNR facility will be inhibited (until new entries < 32 digits) and further entries will be buffered in FIFO.

Pauses can be inserted by pressing the **PS** key (not AS2535).

Post dialled digits, i.e. digits manually entered after LNR has been invoked, are not stored in RAM but buffered in FIFO.

Repeat Dialling (not AS2535)

The last manually dialled number can be repeated without going on-hook by pressing the **RP** key. If a called number is engaged, pressing the **RP** key will break the line for 1.6 second (to get a new dial tone) and after a pause the number will be repeated.

The repeat function is enabled when prior to pressing the **RP** key, a number has been dialled, and it can be invoked an unlimited number of times until next on-hook. During the 1.6 second break the device is in power down mode to save current.

Recall Function

A recall (**R1**, **R2** or **R3** key) activation will invoke a flash (timed loop break), however, the **R1** flash is never executed in LD mode. **R2** and **R3** will be executed independent of the mode.

If recall is the first entry in a digit string, it will be stored in LNR RAM when digit(s) are entered after the recall.

If the recall key is depressed after a digit string has been entered or dialled out, the recall will not be stored but buffered in the FIFO together with subsequently entered digit.

If pressing the recall key is not followed by digit entries, the LNR RAM remains intact.

After a recall a 270 ms pause will automatically be executed.

Memory Keys (not AS2534)

The keys **M1** to **M12** are direct memory access keys and the **MR** key (AS2533/6 only) is used for abbreviated dialling.

Memory arrangement	AS2533/6	AS2534	AS2535
Storable numbers	14	0	12
Direct memory keys	4	0	12
Indirect memories	10	0	0

In the on chip RAM, numbers can be stored. Each number can contain up to 21 digits (including pauses).

During programming multiple pauses can be inserted by pressing the **PS** (not AS2535) or the **LNR** key. Each pause inserted within the first 5 entries will automatically be terminated after 2 seconds whereas pauses inserted after location 5 in a digit string will halt dialling and can be terminated manually by pressing the **PS** (not AS2535) or the **LNR** key. The halt function allows in-dialling to an extension on a PABX.

Example (45678–123 is stored in M1, where – is a pause/wait and 123 the extension number):

```
off-hook, wait for dial tone
press M1 (45678 is dialled out)
await dial tone from called PABX
press PS or LNR (123 is dialled out).
```

Memory dialling is cascadable. However, the content of one memory must be dialled out before a new can be invoked.

Sliding Cursor Procedure

To accommodate easy and uncomplicated redialling (LNR) behind a PABX, a sliding cursor protocol is implemented. If new entries match the previous RAM contents, pressing the **LNR** key will dial out the remaining digits.

If there is an error in matching, the LNR will be inhibited until next on-hook, and the RAM will contain the new number.

Example (LNR content 912345, where 9 is access code):

```
off-hook, wait for PABX dial tone
press 9 and wait for external dial tone
press LNR (12345 will be dialled out).
```

Tone Generator

The tone generator incorporates the DTMF tones, 3 basic frequencies for the tone ringer and pacifier tones.

DTMF

The DTMF generator provides 8 frequencies, namely:

Low group

Digit 1-2-3-A	697 Hz
Digit 4-5-6-B	770 Hz
Digit 7-8-9-C	852 Hz
Digit * -0-# -D	941 Hz

High group

Digit 1-4-7- *	1209 Hz
Digit 2-5-8-0	1336 Hz
Digit 3-6-9-#	1477 Hz
Digit A-B-C-D	1633 Hz (not AS2535)

The MF output level can be set with an external voltage divider on pin MFL.

Voltage at pin MFL (2)	DTMF Level (Low Group)
1.50 V (A_{GND})	-4.0 dBm
1.27 V	-5.2 dBm
1.15 V	-6.4 dBm
1.03 V	-7.6 dBm
0.90 V	-8.8 dBm
0.70 V	-10.0 dBm
0.54 V	-11.2 dBm
0.42 V	-12.4 dBm
0.30 V	-13.6 dBm
0.18 V	-14.8 dBm
0.00 V (V_{SS})	-16.0 dBm

($Z_{LINE} = 600 \text{ ohm}$)

The preemphasis is 2.6 dB.

The MF tones are according to CEPT recommendations.

Tone Ringer (Melody/Volume)

The three basic frequencies of the melodies are:

F1 = 800 Hz, F2 = 1067 Hz, and F3 = 1333 Hz ($\pm 5\%$).

The repetition rate and the volume of the tone ringer melodies can be programmed by pressing **P/M** and **#** followed by a digit as follows (not AS2534E):

<u>Digit</u>	<u>Repetition Rate</u>	<u>Volume</u>
1	1 time (50 ms pause)	- 16 dB
2	1 time (50 ms pause)	- 7 dB
3	1 time (50 ms pause)	0 dB (max.)
4	4 times	- 16 dB
5	4 times	- 7 dB
6	4 times (default)	0 dB (max.)
7	10 times	- 16 dB
8	10 times	- 7 dB
9	10 times	0 dB (max.)
0	None	Off

The procedure is ended by repressing the **P/M** key.

The default setting is digit 6, i.e. after a power on reset the device will start up with repetition rate 4 and maximum volume. If digit **0** is programmed, the tone ringer will be turned off until next off-hook where it will turn back to the last setting before **0**. The programmed settings are stored in the on chip RAM.

Repetition rate means that a sequence of 6 frequencies is repeated 1, 4 or 10 times within 1 second.

The sequence of the frequencies is controlled by the sequence register as follows:

Sequence F1 F2 F3 F1 F2 F3 ...

The AS2534E is fixed to default settings and can not be programmed to other settings.

Pacifier Tone

By MF dialling the DTMF tones are provided to the earpiece as comfort tone.

During programming a key entry is acknowledged by a pacifier tone of 1477 Hz. The level of the pacifier tone is approximately 60 mV at the RO output. The duration is 40 ms after every key entry in programme mode.

When terminating the programme mode with the **P/M** key an acknowledge tone of 140 ms is provided. An invalid key entry, however, will cause a termination of the programme mode indicated by a rejection tone of 4 times 40 ms with 28 ms pauses between the tone bursts.

Ring Frequency Discrimination

The ring frequency discriminator assures that only signals with a frequency between 13Hz and 70 Hz are regarded as valid ring signals. The time for recognising a valid ring signal is 1/f seconds, where 'f' is the ring frequency.

When a valid ring signal is present for 73 ms continuously, the melody generator is activated and remains active as long as the ring signal is present.

Once the melody generator has been started, the ring signal is continuously monitored and the melody generator is instantly turned on or off according to the momentary presence of a valid or invalid ring signal respectively (until next POR or off-hook).

Typical Characteristics of Line Loss Compensation

Fig. 4

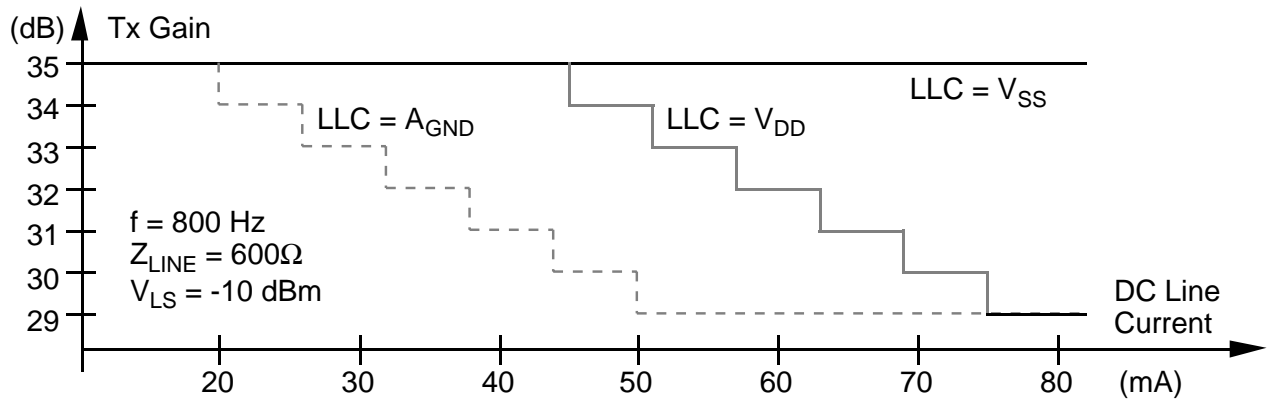
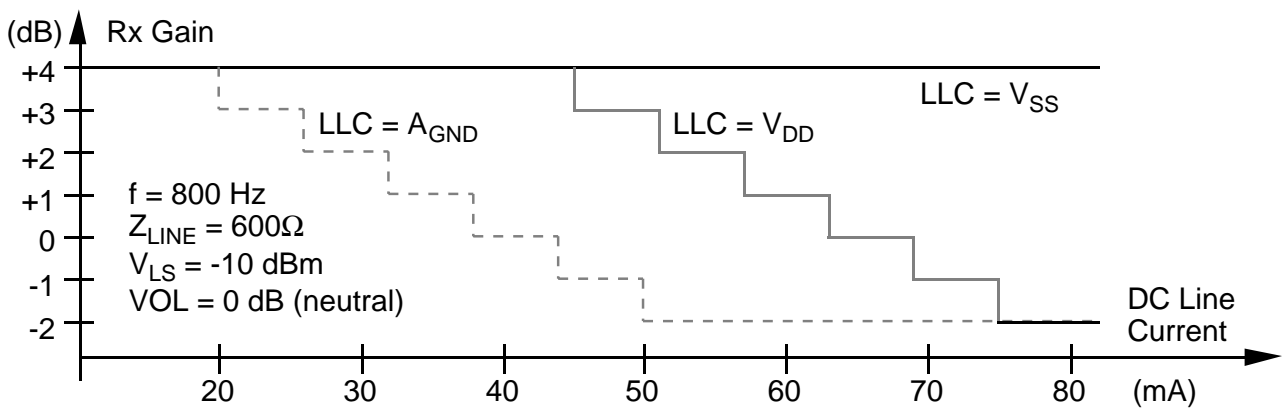
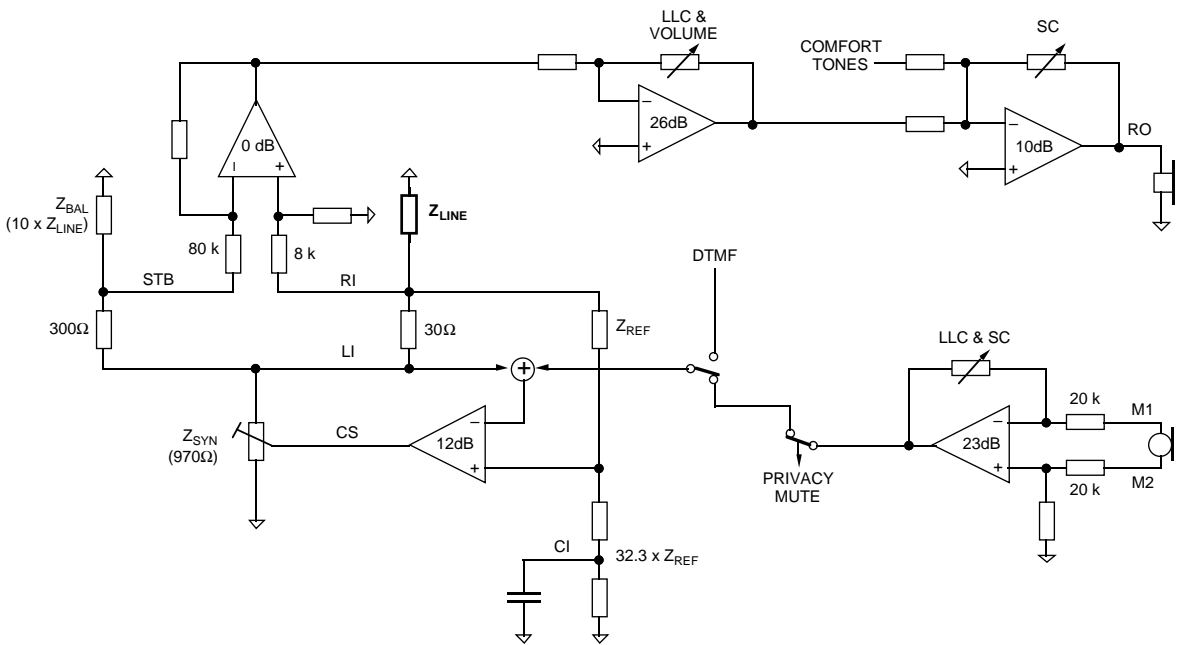

Fig. 5



AC Model of Speech Circuit

Figure 8



Typical Application

Complex Impedance
($270 \Omega + 750 \Omega // 150 \text{ nF}$)

Figure 9

Only the components necessary for presenting the complete functions of the AS253X are included.

The external components might change to comply with various national PTT regulations and to interface to different transducers.

Since the AS253x is a component and not a complete system, it can not be approved as a stand alone part by the standard bodies. Hence, full conformance to any standards is depending on the application in which the AS253x is being used, and therefore, approvals by the standard bodies are the responsibility of the customer and Austria Mikro Systeme will not have tested the product to meet specific standards.

For further application information please refer to application note AN2201.

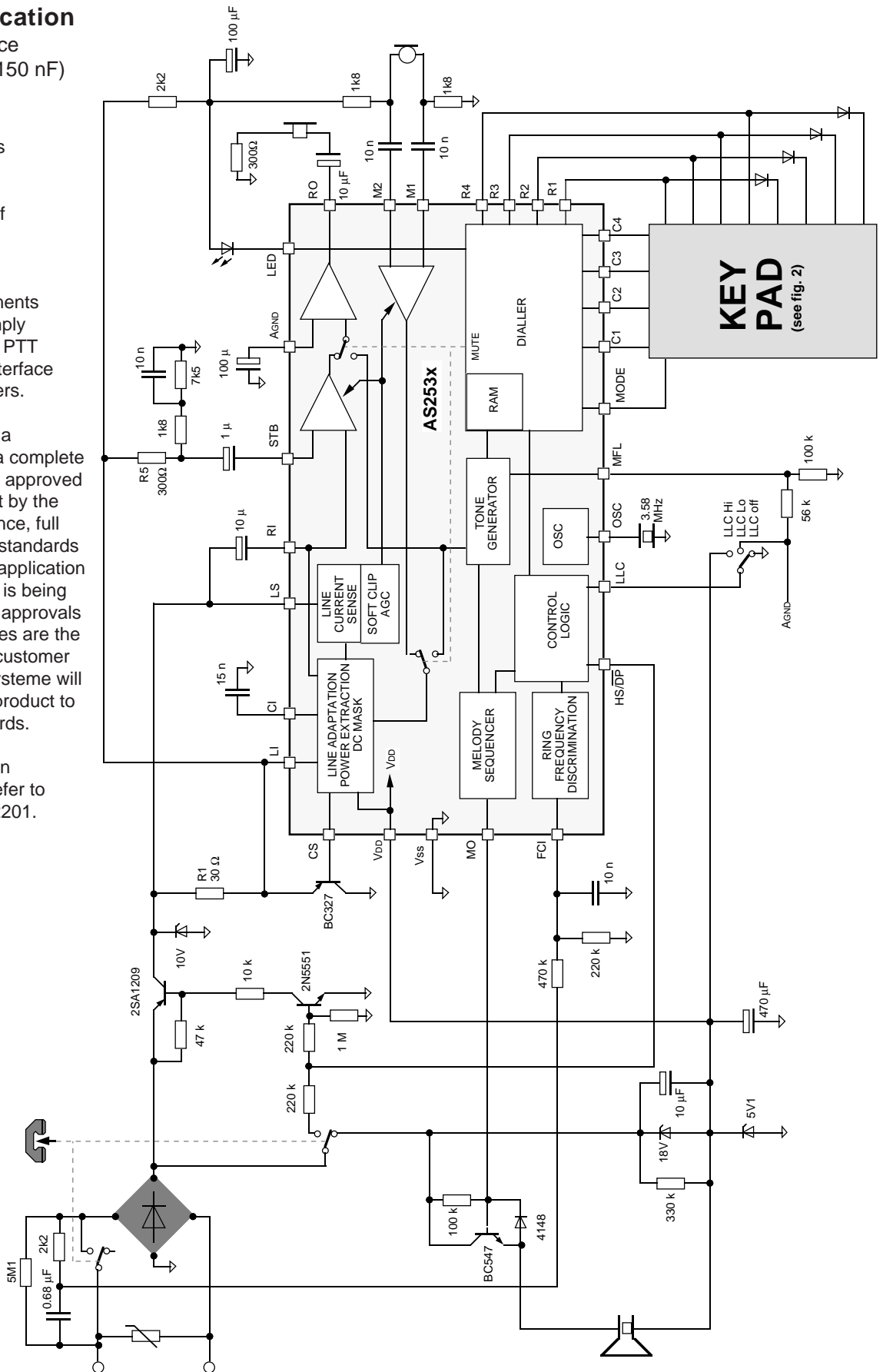

Operating Procedures









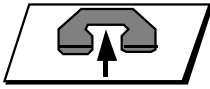

Procedure Principles

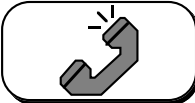
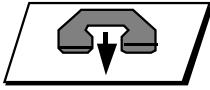
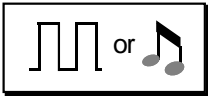
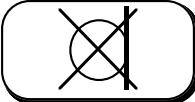
The procedures for utilizing the features of the AS253x are optimized out of consideration for the human factor in order to:

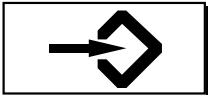
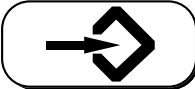
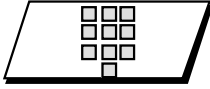
- meet the user's expectations
- be easy to learn and relearn
- not invoke any automatic functions which the user doesn't expect
- protect the user from committing critical errors, e.g. dialling wrong numbers, deleting stored numbers, etc.
- be consistent, simple and usable.

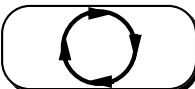
The following pages describe the operating procedures for the provided features. Pressing an invalid key or key combination during programming will cause the device to abort the programme state. Pressing any key combination or sequence which is not described or defined may cause the device to enter a state or mode that does not comply with the expectation of the user. In such cases, any undesired state can be terminated at any time by going on-hook / off-hook which will generate a functional reset.

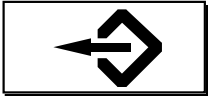
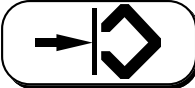
Symbols

STATES	ENTRIES	PROCESSING
 Idle (on-hook, no ringing)	 Going off-hook	 Time out (x sec.)
 Speech mode	 Going on-hook	 Dialling (LD or MF)
 Privacy mute	 Pressing a key	 Storing (writing into RAM)
 Programming	 Entering a number	 Processing according to text
 False programme entry	 Entry according to text	 reading from memory
 Invalid entry		
 State according to text		

Programming Tone Ringer
(not AS2534E)

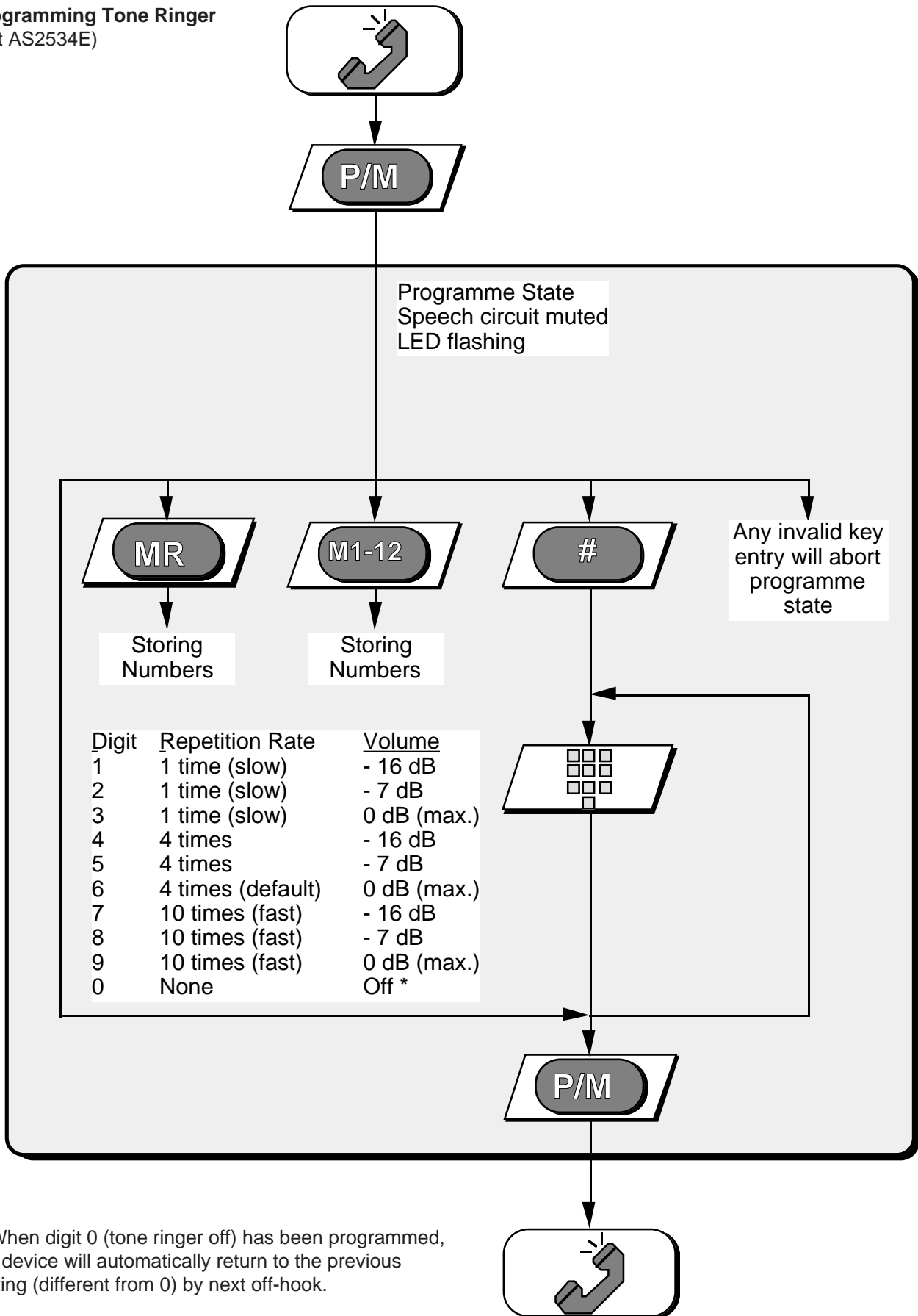

*) When digit 0 (tone ringer off) has been programmed, the device will automatically return to the previous setting (different from 0) by next off-hook.

Temporary MF

MODE pin connected to row 1, 2, 3, 4 or 5

When MODE pin = row 5, pressing the * key also transmits the tone by MF select. The T/P key (not AS2535) can be used alternatively to the * key.

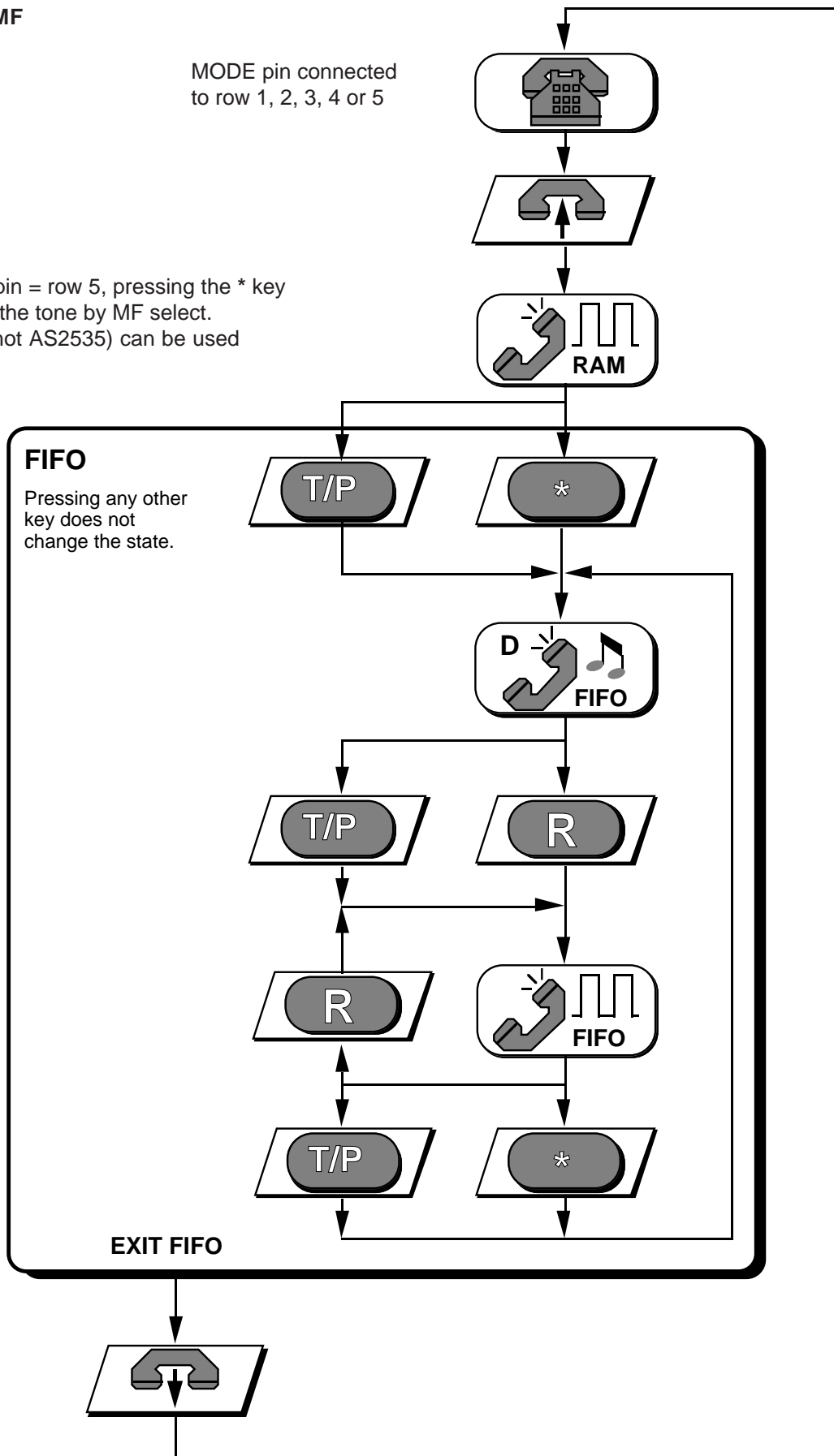

Storing Numbers (not AS2534)

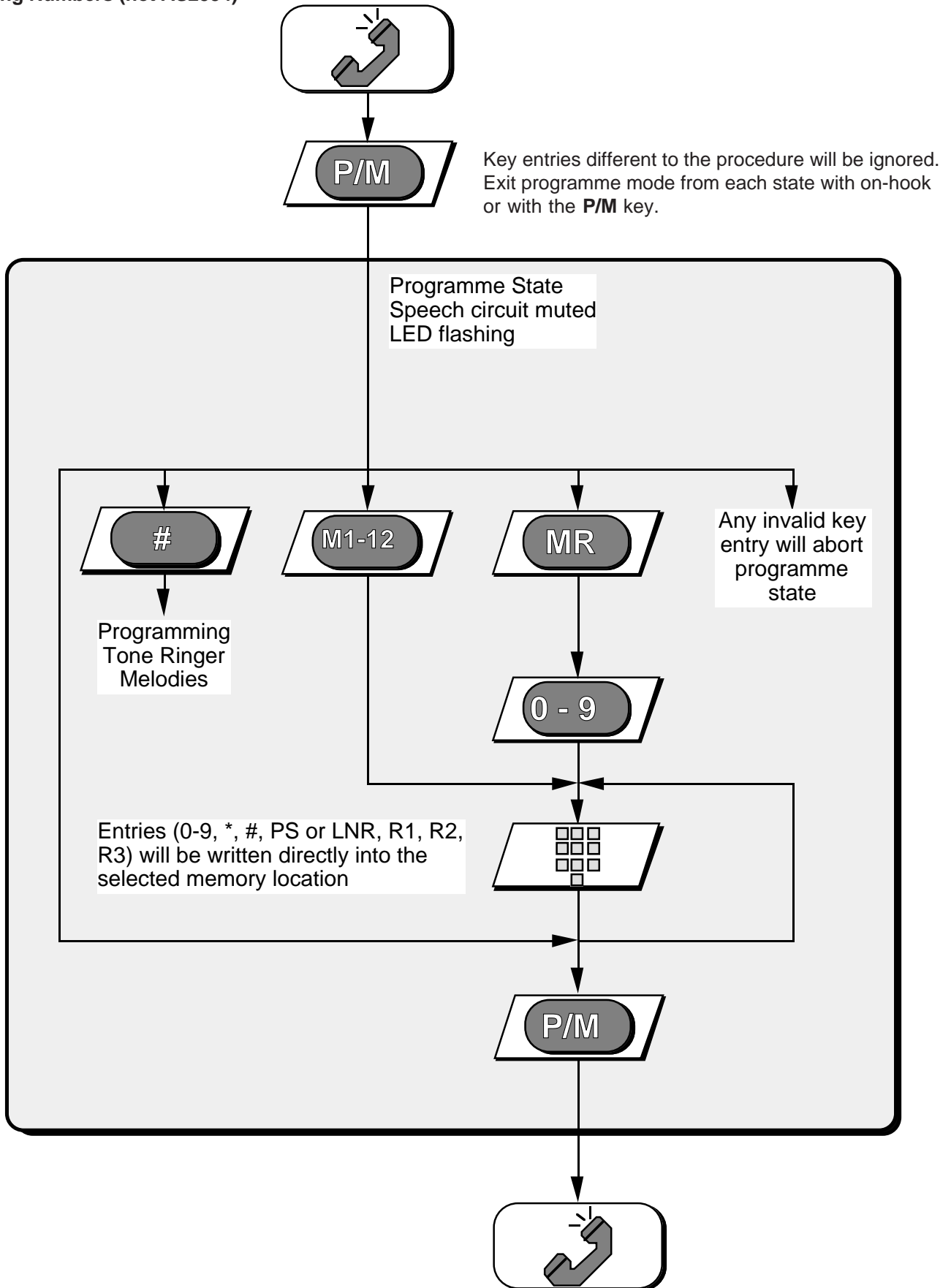

Automatic Dialling

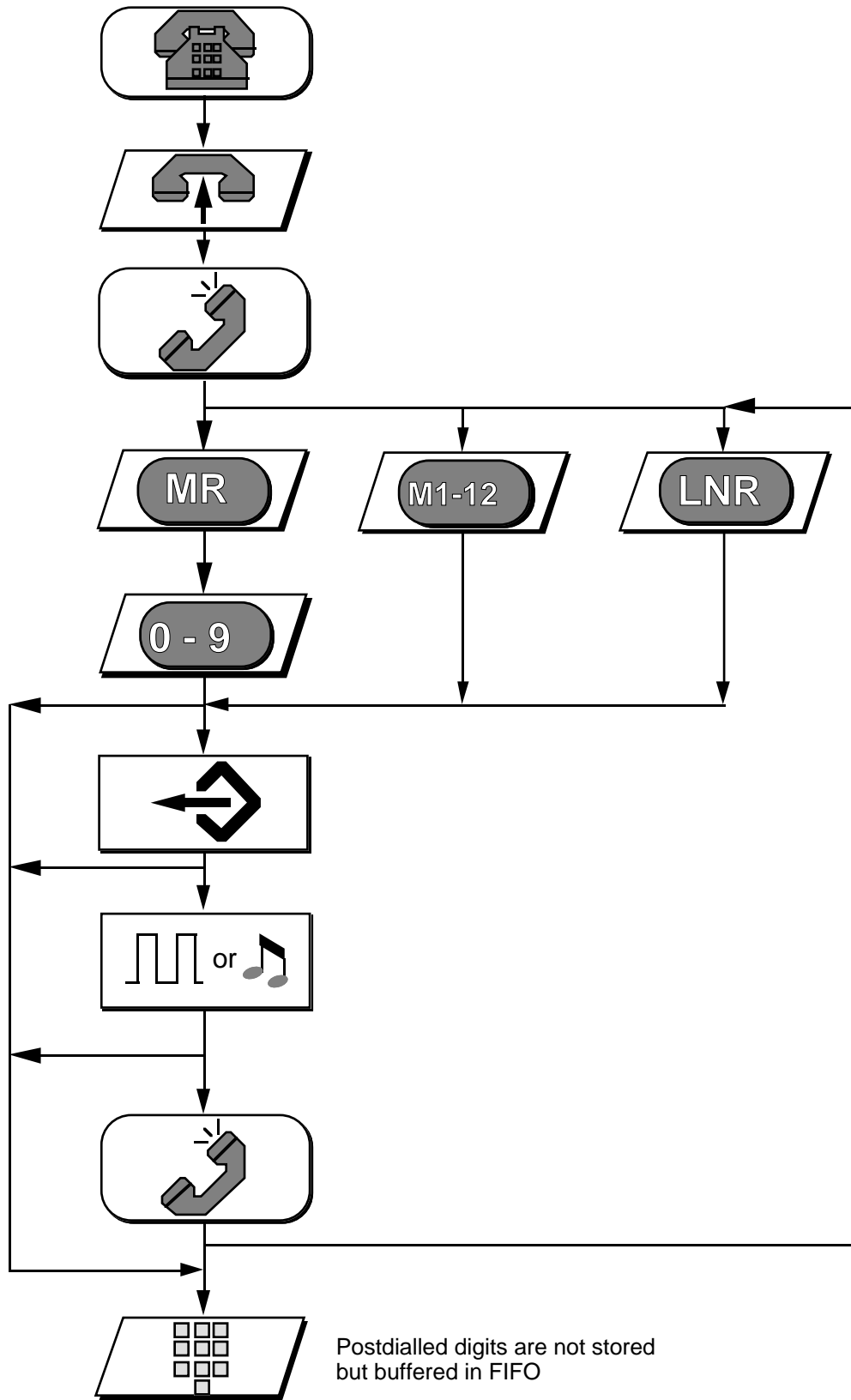

Timing Diagrammes

LD Dialling

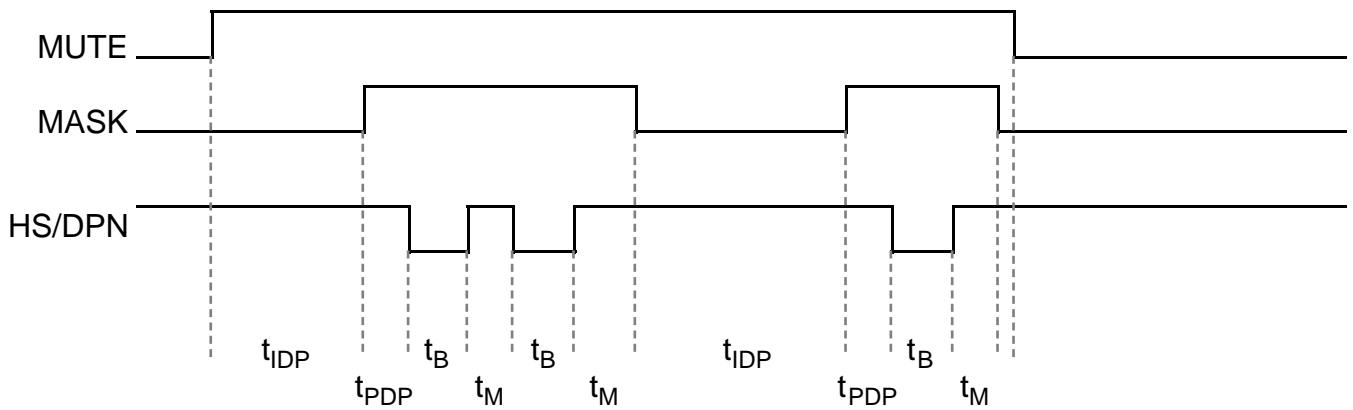

LD Dialling With Access Pause

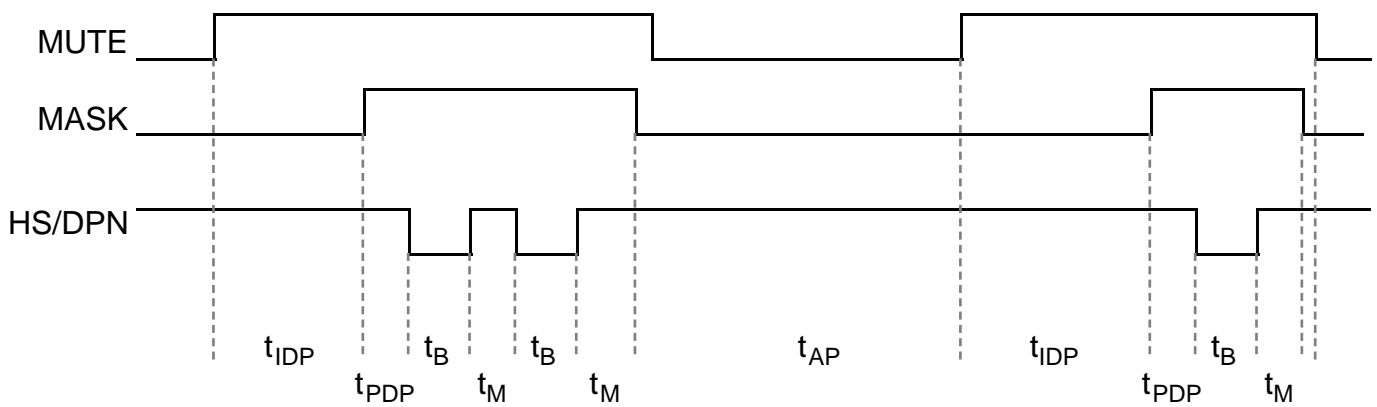

MF Dialling

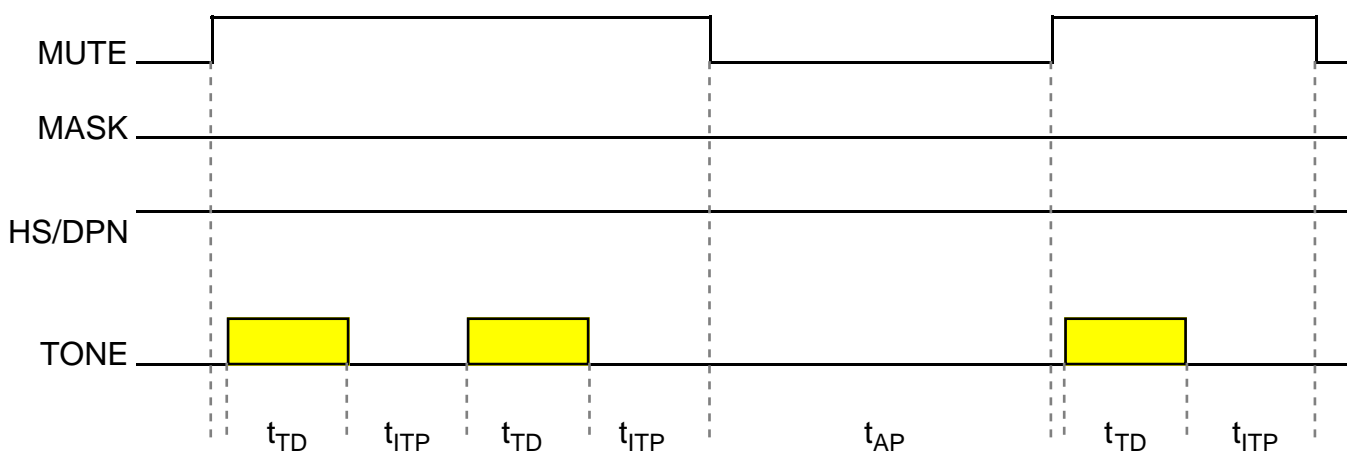

Continues....

Flash

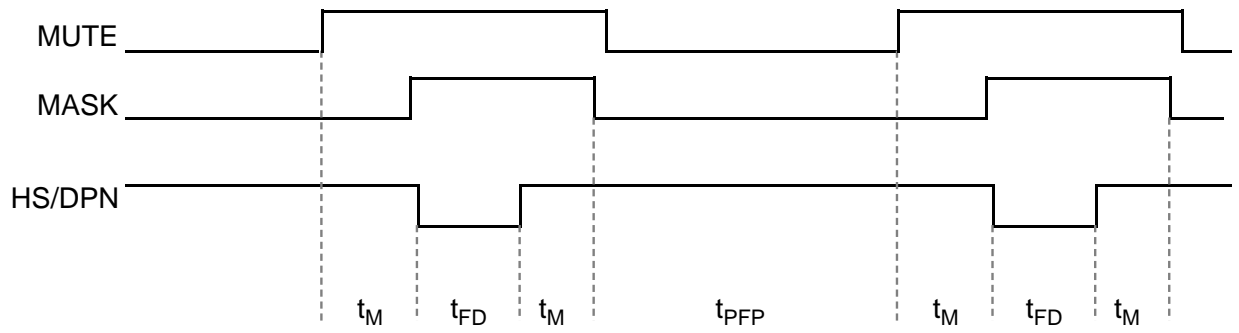

Repeat Dialling (not AS2535)

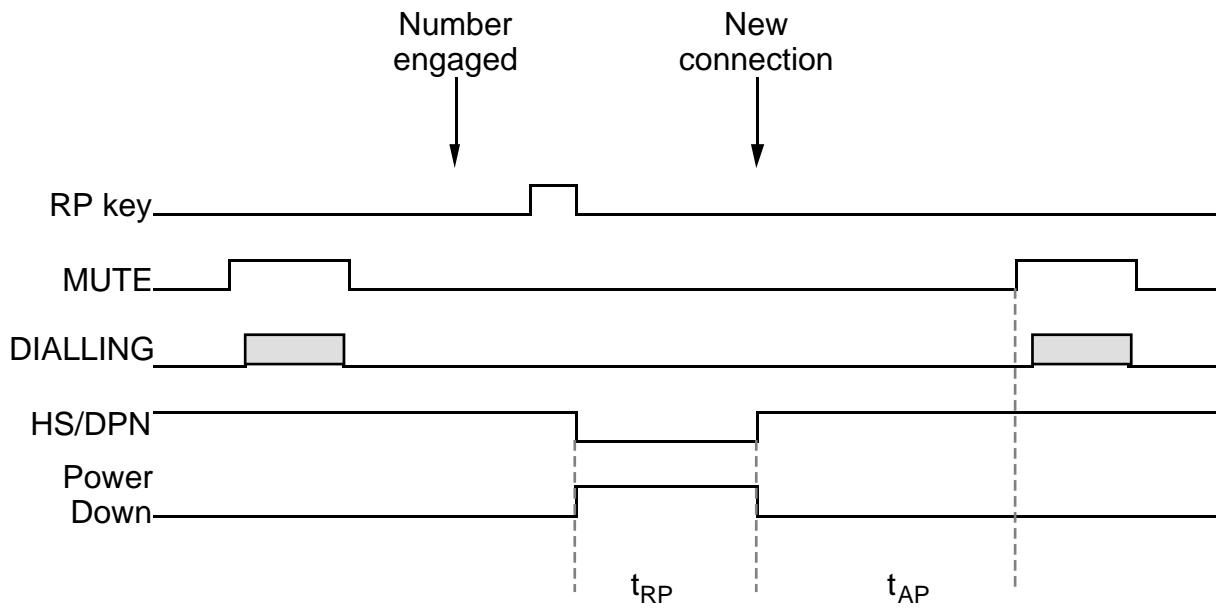

Electrical Characteristics**Absolute Maximum Ratings**

Positive Supply Voltage	$-0.3V \leq V_{DD} \leq 7V$
Input Current	$\pm 25 \text{ mA}$
Input Voltage (LS)	$-0.3V \leq V_{IN} \leq 10V$
Input Voltage (LI, CS)	$-0.3V \leq V_{IN} \leq 8V$
Input Voltage (STB, RI)	$-2V \leq V_{IN} \leq V_{DD} + 0.3V$
Input Voltage (MO)	$-0.3V \leq V_{IN} \leq +35V$
Digital Input Voltage	$-0.3V \leq V_{IN} \leq V_{DD} + 0.3V$
Electrostatic Discharge	$\pm 1000V$
Storage Temperature	-65°C to $+125^{\circ}\text{C}$

Recommended Operating Conditions

Supply Voltage * (Speech Mode)	$4V \leq V_{DD} \leq 5V$
Oscillator Frequency (Resonator: Murata CSA 3.58M G312AM)	3.58 MHz
Operating Temperature	-25°C to $+70^{\circ}\text{C}$

* This voltage is generated internally

DC Characteristics ($I_{LINE} = 15 \text{ mA}$ unless otherwise specified)

Symbol	Parameter	Conditions	Min	Typ	Max	Units
I_{DD}	Operating Current	Speech mode		3	5	mA
		MF dialling		4		mA
		LD dialling, $V_{DD} = 2.5V$		200		μA
		Ring mode, $V_{DD} = 2.5V$		300		μA
I_{DD0}	Retention Current	Idle mode, $V_{DD} = 2V$ $T_{AMB} = 25^{\circ}\text{C}$		0.05		μA
V_{LI}	Line Voltage (default)	$13 \text{ mA} \leq I_{LINE} \leq 100 \text{ mA}$		4.5		V
I_{OL}	Output Current, Sink CS, HS/DP, MO	$V_{OL} = 0.4V$		1.5		mA
I_{OL}	Output Current, Sink; LED	$V_{OL} = 0.4V$		4		mA
V_{IL}	Input Low Voltage	HS/DPN; FCI $T_{AMB} = 25^{\circ}\text{C}$	V_{SS}		$0.3 V_{DD}$	V
V_{IH}	Input High Voltage	HS/DPN; FCI $T_{AMB} = 25^{\circ}\text{C}$	$0.7 V_{DD}$		V_{DD}	V

AC Characteristics ($I_{LINE} = 15 \text{ mA}$; $f = 800 \text{ Hz}$ unless otherwise specified)

Symbol	Parameter	Conditions	Min	Typ	Max	Units
Tx	Transmit	Test Circuit Fig. 10				
A_{TX}	Gain, Transmit	M1/M2 to LI	35.1	36.6	38.1	dB
$\Delta A_{TX/F}$	Variation with Frequency	$f = 500 \text{ Hz to } 3.4 \text{ kHz}$		± 0.8		dB
THD	Distortion	$V_{LI} \leq 0.25V_{RMS}$			2	%
V_{AGC}	Soft Clip Level	$V_{LI} =$		2		V_{PEAK}
A_{SCO}	Soft Clip Overdrive			20		dB
t_{ATTACK}	Attack Time			30		$\mu\text{s}/6 \text{ dB}$
t_{DECAY}	Decay Time			20		$\text{ms}/6\text{dB}$
Z_{IN}	Input Impedance (M1/M2)			20		$\text{k}\Omega$
A_{MUTE}	Mute Attenuation	Mute activated	60			dB
V_{NO}	Noise Output Voltage	$T_{AMB} = 25^\circ\text{C}$			-72	dBmp
$V_{IN \text{ Max}}$	Input Voltage Range (M1/M2)	Differential Single Ended		± 1 ± 0.5		V_{PEAK} V_{PEAK}
BJT	Output Driver					
$V_{IN \text{ MAX}}$	Input Voltage Range (LI)			± 2		V_{PEAK}
V_{TX}	Dynamic Range			± 2		V_{PEAK}
RL	Return Loss	$Z_{RL} = 1000\Omega$; $T_{AMB} = 25^\circ\text{C}$	18			dB
$\Delta Z_{AC/TEMP}$	Temperature Variation			0.5		$\Omega/^\circ\text{C}$
Rx	Receive	Test Circuit Fig. 10				
A_{RX}	Receive Gain (Vol. default)	LI to RO	1.5	3	4.5	dB
A_{VOL}	Volume Gain	VOL key		+5.4		dBr
A_{VOL}	Volume Gain	-/+ keys		-5.4/+8.1		dBr
$\Delta A_{RX/F}$	Variation with Frequency	$f = 500 \text{ Hz to } 3.4 \text{ kHz}$		± 0.8		dB
THD	Distortion	$V_{RI} \leq 0.25V_{RMS}$			2	%
V_{AGC}	Soft Clip Level	$V_{RO} =$		1		V_{PEAK}
A_{SCO}	Soft Clip Overdrive			10		dB
t_{ATTACT}	Attact Time	$V_{RI} > 0.8V_{RMS}$		30		$\mu\text{s}/6 \text{ dB}$
t_{DECAY}	Decay Time			20		$\text{ms}/6\text{dB}$
V_{NO}	Noise Output Voltage	$T_{AMB} = 25^\circ\text{C}$			-72	dBmp
V_{UFC}	Unwanted F. Components	50 Hz....20 kHz			-60	dBm
Z_{IN}	Input Impedance (RI)			8		$\text{k}\Omega$
$V_{IN \text{ RI}}$	Input Voltage Range (RI)			± 2		V_{PEAK}
A_{ST}	Sidetone Cancellation	$V_{RI} \leq 0.25V_{RMS}$	26			dB
$V_{IN \text{ ST}}$	Input Voltage Range (STB)			± 2		V_{PEAK}
Z_{IN}	Input Impedance (STB)			80		$\text{k}\Omega$

AC Characteristics (cont'd) ($I_{\text{LINE}} = 15 \text{ mA}$; $f = 800 \text{ Hz}$ unless otherwise specified)

Symbol	Parameter	Conditions	Min	Typ	Max	Units
t_D	Keyboard Key Debounce Time			15		ms
$t_{\text{HS-L}}$	HS/DPN Input Low to High Debounce	Going off-hook		15		ms
$t_{\text{HS-H}}$	High to Low Debounce	Not LD dialling		210		ms
		During LD dialling		270		ms
F	DTMF Frequency deviation	Note 5			1.2	%
V_{MF}	MF Tone Level (Low group)	$\text{MFL} = A_{\text{GND}}$	- 2.5	- 4	- 5.5	dB
		$\text{MFL} = V_{\text{SS}}$	- 14.5	- 16	- 17.5	dB
$\Delta V_{\text{L-H}}$	Preemphasis Low to High		1.8	2.4	3.0	dB
V_{UFC}	Unwanted F. Componets Note 3; $\text{MFL} = V_{\text{SS}}$	300 Hz...5 kHz			-40	dBm
		5 kHz...14 kHz			-50	dBm
		14 kHz...28.5 kHz			-70	dBm
		28.5 kHz...40 kHz			-80	dBm
t_{TD}	Tone Duration	Note 1&6; Mode=row 6 or 7	80	82.3	85	ms
t_{ITP}	Inter Tone Pause	Note1; Mode=row 6	80	82.3	85	ms
t_{ITP}	Inter Tone Pause	Note 1 & 6; Mode=row 7	150	165	170	ms
t_{TR}	Tone Rise Time	Note 2			5	ms
t_{TF}	Tone Fall Time	Note 2			5	ms
t_{DR}	LD Dial Rate	Mode = row 1, 2 or 5	9.53	10	10.5	pps
		Mode = row 3 or 4	19.05	20	21	pps
t_{B}	Break Period	Mode = row 2	57	61.2	63	ms
t_{B}	Break Period	Mode = row 4	28.5	30.6	31.5	ms
t_{B}	Break Period	Mode = row 1 or 5	63	66	69	ms
t_{B}	Break Period	Mode = row 3	31.5	33	34.5	ms
t_{M}	Make Period	Mode = row 2	38	40.8	42	ms
t_{M}	Make Period	Mode = row 4	19	20.4	21	ms
t_{M}	Make Period	Mode = row 1 or 5	31.5	33	34.5	ms
t_{M}	Make Period	Mode = row 3	15.7	16.5	17.3	ms
t_{PDP}	Pre-Digit Pause			35		ms
t_{IDP}	Inter Digit Pause	Mode = row 1, 2, 3, 4 or 5	800	840	880	ms
$t_{\text{HS-H}}$	High to Low Debounce	During LD dialling		270		ms
t_{MO}	Mute Overhang			t_{M}		

Symbol	Parameter	Conditions	Min	Typ	Max	Units
t_{FD}	Flash Duration 1	R1 key	100		102	ms
	Flash Duration 2	R2 key	270		300	ms
	Flash Duration 3	R3 key (AS2533/4B/5/6)	600		650	ms
		R3 key (AS2534E only)	312	375	450	ms
t_{PFP}	Post Flash Pause			274		ms
t_{AP}	Access Pause	Note 8	2.0	2.05	2.12	sec
t_{RP}	Repeat Break Time			1.6		sec
	Tone Ringer					
V_{MO}	Melody Output			PDM		
t_{MD}	Melody Delay				10	ms
F1	Frequency 1			800		Hz
F2	Frequency 2			1067		Hz
F3	Frequency 3			1333		Hz
t_{DT}	Detection Time	Initial		1/f + 73ms		s
t_{TO}	Detection Time-out			note 4		ms
f_{MIN}	Min. Detection Frequency			13		Hz
f_{MAX}	Max. Detection Frequency			70		Hz
	Pacifier Tone	Programme Mode Only				
f_{PT}	Frequency	P/M mode, key entry		1477		Hz
V_{RT}	Level (RO)	Key entry		60		mV
t_{RTD-E}	Duration, Key Entry	Valid key entry, prog.		40		ms
t_{RTD-A}	Duration, Acknowledge	Terminate with P/M key		140		ms
t_{RTD-R}	Duration, Reject	Invalid key entry, note 7		4x40		ms
	LED Output					
t_{LED-ON}	"on-time"	P/M state		80		ms
$t_{LED-OFF}$	Interval	P/M state		1		sec
	Comfort Tone (DTMF)					
V_{CT}	Level (RO)	Relative to LS		-30		dBr

Note 1: The values are valid during automatic dialling and are minimum values during manual dialling, i.e. the tones will continue as long as the key is depressed.

Note 2: The rise time is the time from 10% of final value till the tone amplitude has reached 90 % of its final value.

Note 3: Relative to high group.

Note 4: The FCI circuit is reset by POR and HS/DPN pulled high (off-hook). After a reset the FCI circuit is in a standby state. A positive edge on FCI will start a 73 ms timer and the frequency discrimination is initiated. Whenever a period of the ring signal is missing, the timer is reset. When a valid ring signal is present for 73 ms, the melody generator is started and is directly controlled by the ring signal. This condition will remain until a new reset.

Note 5: This does not include the frequency deviation of the ceramic resonator.

Note 6: During temporary MF mode.

Note 7: An invalid key entry in programme mode will invoke a tone sequence with 4 tone bursts of 40 ms and pauses between bursts of 28 ms and abort the programme mode.

Note 8: Pauses inserted within the first 5 entries of a digit string will be automatically terminated after 2 seconds. Pauses inserted after location 5 can only be terminated manually by pressing the PS or LNR key.

Test Circuit

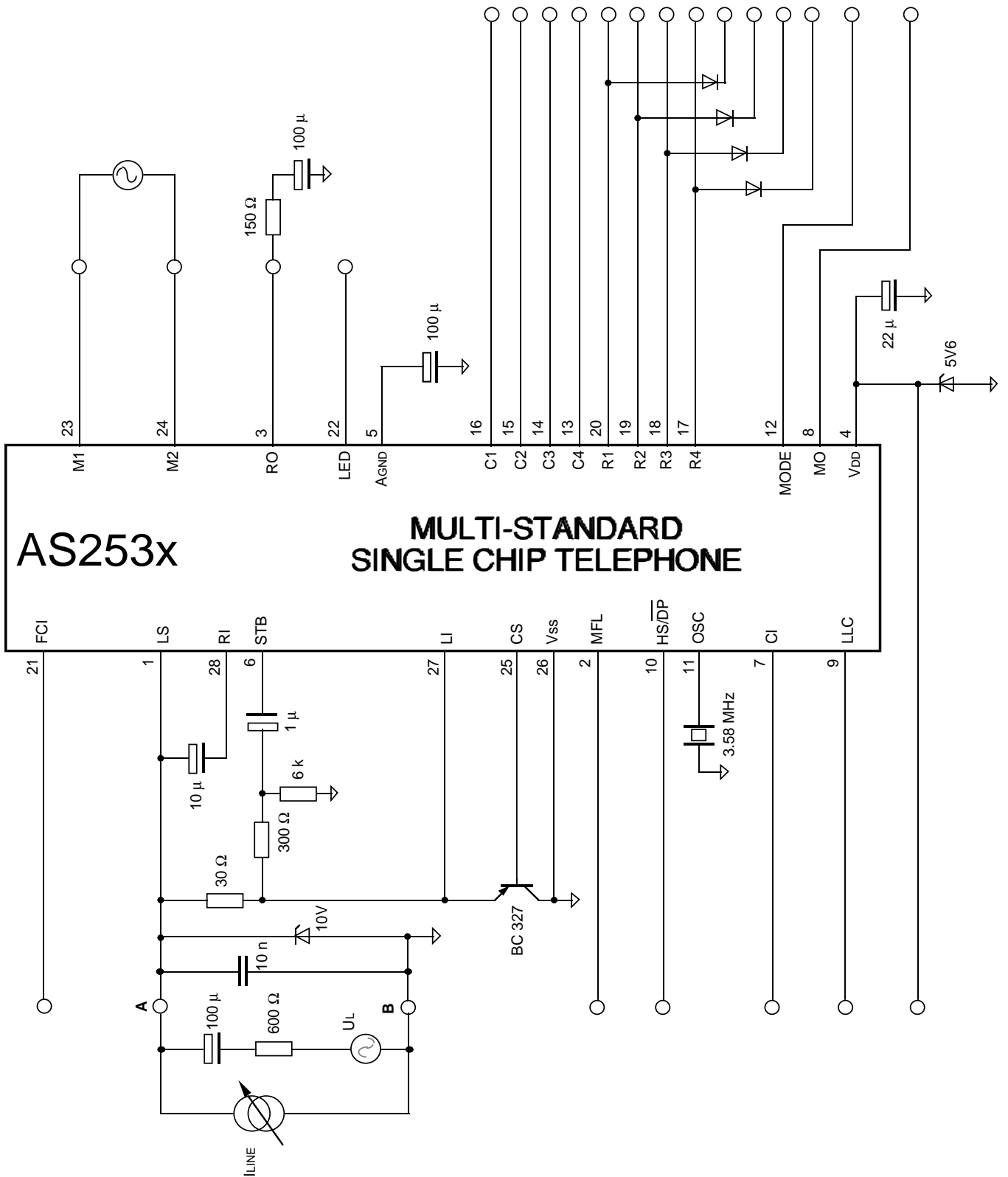

Figure 10

Characteristic Curves (Typical)

Fig. 11 Receive Soft Clipping and Distortion

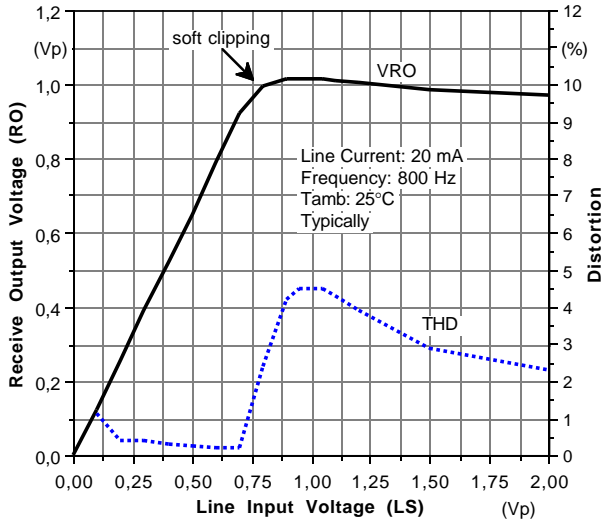

Fig. 12 Transmit Soft Clipping and Distortion

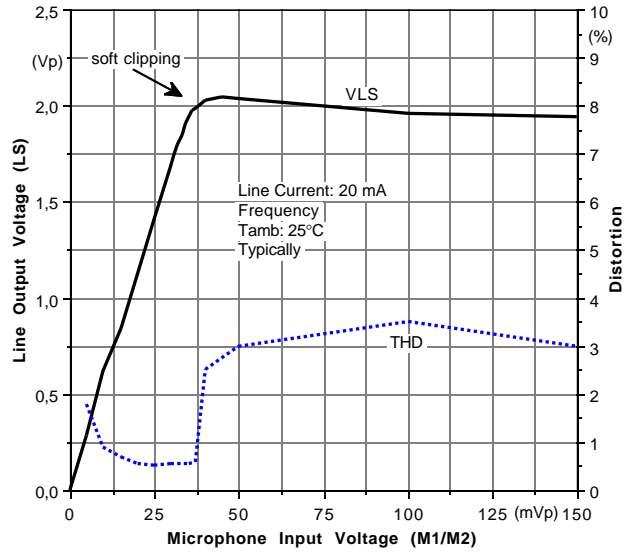
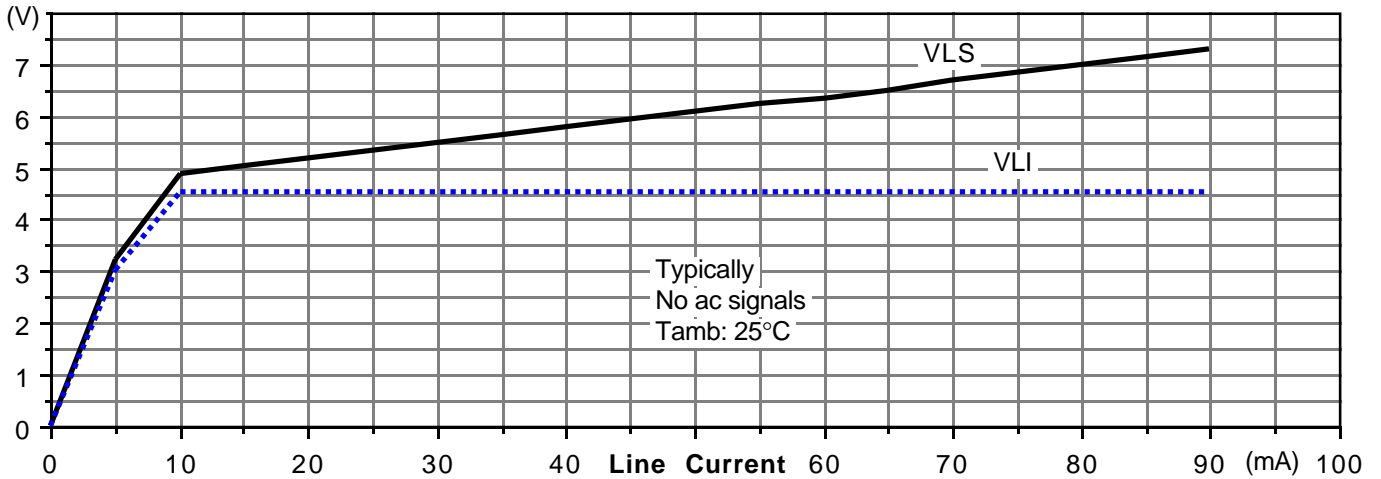

Fig. 13 DC Mask



Pin Configuration

28 Pin DIP (suffix P)

28 Pin SOIC (suffix T)

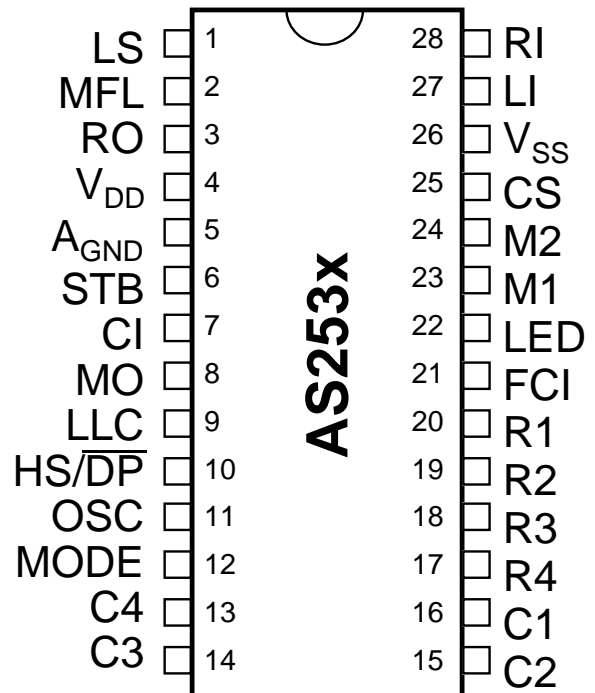
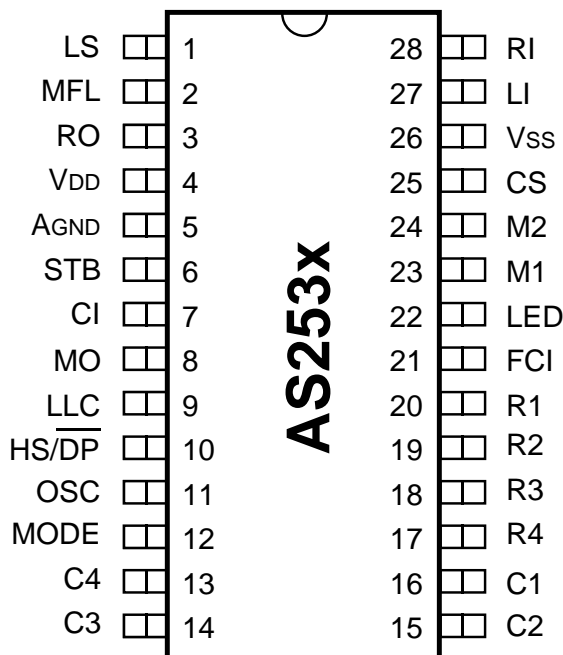

Ordering Information

Device	Package	Memories	Volume	Centrex	Special keys
AS2533 T	28 pin SOIC	4 direct/10 indirect	yes, note 1	A B C D	P/M, LNR, R1-3, MR, RP, PS, T/P
AS2533 P	28 pin DIP	4 direct/10 indirect	yes, note 1	A B C D	P/M, LNR, R1-3, MR, RP, PS, T/P
AS2534B T	28 pin SOIC	none	yes, note 2	A B C D	P/M, LNR, R1-3, RP, PS, T/P
AS2534B P	28 pin DIP	none	yes, note 2	A B C D	P/M, LNR, R1-3, RP, PS, T/P
AS2534E P	28 pin DIP	none	yes, note 2	A B C D	MT, LNR, R1-3, RP, PS, T/P
AS2534E T	28 pin SOIC	none	yes, note 2	A B C D	MT, LNR, R1-3, RP, PS, T/P
AS2535 T	28 pin SOIC	12 direct	yes, note 1	no	P/M, LNR, R1-3
AS2535 P	28 pin DIP	12 direct	yes, note 1	no	P/M, LNR, R1-3
AS2536 T	28 pin SOIC	4 direct/10 indirect	yes, note 2	A B C D	P/M, LNR, R1-3, MR, RP, PS, T/P
AS2536 P	28 pin DIP	4 direct/10 indirect	yes, note 2	A B C D	P/M, LNR, R1-3, MR, RP, PS, T/P

Conditions for delivery as dice see also data sheet AS2533/4B/5/6-CX.

Note 1: volume is reset to default by on-/off-hook and by POR

Note 2: volume is reset by POR only.

Application:

For application support contact your local sales offices.

Devices sold by Austria Mikro Systeme/Thesys are covered by the warranty and patent idemnification provisions appearing in its Term of Sale. Austria Mikro Systeme/Thesys makes no warranty, express, statutory, implied, or by description regarding the information set forth herein or regarding the freedom of the described devices from patent infringement. Austria Mikro Systeme reserves the right to change specifications and prices at any time and without notice. Therefore, prior to designing this product into a system, it is necessary to check with Austria Mikro Systeme for current information. This product is intended for use in normal commercial applications. Applications requiring extended temperature range, unusual environmental requirements, or high reliability applications, such as military, medical life-support or life-sustaining equipment are specifically *not* recommended without additional processing by Austria Mikro Systeme/Thesys for each application.

Copyright © 1995-8, Austria Mikro Systeme International AG, Schloss Premstätten, 8141 Unterpremstätten, Austria. Trademarks Registered ®. All rights reserved. The material herein may not be reproduced, adapted, merged, translated, stored, or used without the prior written consent of the copyright owner.

The information furnished here by Austria Mikro Systeme/Thesys is believed to be correct and accurate. However, Austria Mikro Systeme/Thesys shall not be liable to recipient or any third party for any damages, including but not limited to personal injury, property damage, loss of profits, loss of use, interruption of business or indirect, special, incidental or consequential damages, of any kind, in connection with or arising out of the furnishing, performance or use of the technical data herein. No obligation or liability to recipient or any third party shall arise or flow out of Austria Mikro Systeme/Thesys' rendering of technical or other services.