

Stereo 290mW 8Ω Speaker Driver

Features

- Operating Voltage
 - Single Supply 3V to 7V
 - Dual Supply $\pm 1.5V$ to $\pm 3.5V$
- High Signal-to-Noise Ratio 100dB
- High Slew Rate 5V/ μs
- Low Distortion -65dB
- Output Power at 10% THD+N
 - into 8Ω 290mW
 - into 16Ω 190mW
- Large Output Voltage Swing
- Excellent Power Supply Ripple Rejection
- Low Power Consumption
- Short-circuit Elimination
- Wide Temperature Range
- No Switch ON/OFF Clicks
- Available in 8 pin SOP or DIP Package

Applications

- Portable Digital Audio
- Personal Computers
- Microphone Preamplifier

General Description

The APA4800 is an integrated class AB stereo headphone amplifier contained in an SO-8 or a DIP-8 plastic package . The APA4800 is capable of delivering 290mW of max . output power to an 8Ω load with less than 10% (THD+N) from a 5V power supply . The device has been primarily developed for portable digital audio applications .

Ordering Information

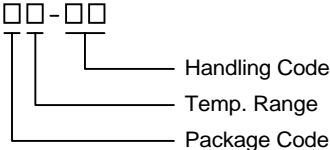
<p>APA4800</p> 	<p>Package Code J : PDIP - 8 K : SOP - 8 Temp. Range I : - 40 to 85 °C Handling Code TU : Tube TR : Tape & Reel</p>
--	--

Block Diagram

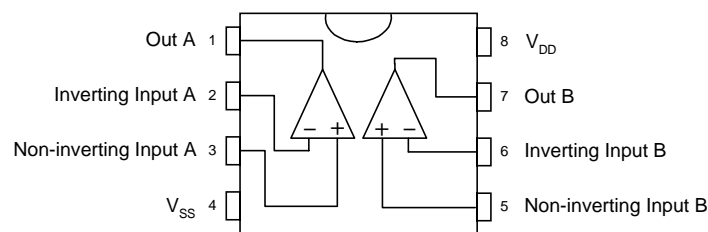

APA4800

ANPEC reserves the right to make changes to improve reliability or manufacturability without notice, and advise customers to obtain the latest version of relevant information to verify before placing orders.

Absolute Maximum Ratings

Symbol	Parameter	Rating	Unit
V_{DD}	Supply Voltage	5	V
$T_{SC(O)}$	Output Short-circuit Duration, at $T_A=25^{\circ}C$, $P_{TOT}=1W$	20	S
T_A	Operating Ambient Temperature range	-40 to 85	$^{\circ}C$
T_J	Maximum Junction Temperature	150	$^{\circ}C$
T_{STG}	Storage Temperature Range	-65 to +150	$^{\circ}C$
T_S	Soldering Temperature, 10 seconds	260	$^{\circ}C$
V_{ESD}	Electrostatic Discharge	-3000 to 3000 *1	V

Note: *1. Human body model : C=100pF, R=1500 Ω , 3 positive pulses plus 3 negative pulses

Thermal Characteristics

Symbol	Parameter	Value	Unit
R_{THJA}	Thermal Resistance from Junction to Ambient in Free Air		
	DIP-8	109	K/W
	SO-8	210	K/W

Electrical Characteristics $T_A=25^{\circ}C$, $f=1kHz$ (unless otherwise noted)

Symbol	Parameter	Test Conditions	APA4800			Unit
			Min.	Typ.	Max.	
V_{DD}	Power Supply Voltage		2.7		5.5	V
$V_{DD}=5V$						
I_{DD}	Supply Current	No Load		2.5		mA
$V_{I(O/S)}$	Input Offset Voltage			5	50	mV
AC Characteristics						
(THD+N)/S	Total Harmonic Distortion plus Noise to Signal Ratio	$P_O=200mW$, $R_L=8\Omega$, $f=1kHz$ $P_O=120mW$, $R_L=16\Omega$, $f=1kHz$		0.1 0.05		%
P_O	Output Power	(THD+N)/S=0.2%, $f=1kHz$ $R_L=8\Omega$ $R_L=16\Omega$		210 140		mW
P_O	Output Power	(THD+N)/S=10%, $f=1kHz$ $R_L=8\Omega$ $R_L=16\Omega$		290 190		mW
PSRR	Power Supply Rejection Ratio	$C_B=2.2 \mu F$, $V_{RIPPLE}=200mV_{rms}$, $f=120Hz$		55		dB
S/N	Signal to Noise Ratio	$R_L=8\Omega$		20		μV_{rms}

Electrical Characteristics Cont. $T_A=25^{\circ}\text{C}$, $f=1\text{kHz}$ (unless otherwise noted)

Symbol	Parameter	Test Conditions	APA4800			Unit
			Min.	Typ.	Max.	
$V_{DD}=3\text{V}$						
I_{DD}	Supply Current	No Load		2.2		mA
$V_{I(OS)}$	Input Offset Voltage			5		mV
AC Characteristics						
(THD+N)/S	Total Harmonic Distortion plus Noise to Signal Ratio	$P_O=50\text{mW}$, $R_L=8\Omega$, $f=1\text{kHz}$ $P_O=40\text{mW}$, $R_L=16\Omega$, $f=1\text{kHz}$		0.15		%
P_O	Output Power	(THD+N)/S=0.2%, $f=1\text{kHz}$ $R_L=8\Omega$ $R_L=16\Omega$		60 45		mW
P_O	Output Power	(THD+N)/S=10%, $f=1\text{kHz}$ $R_L=8\Omega$ $R_L=16\Omega$		90 65		mW

Test And Application Circuits

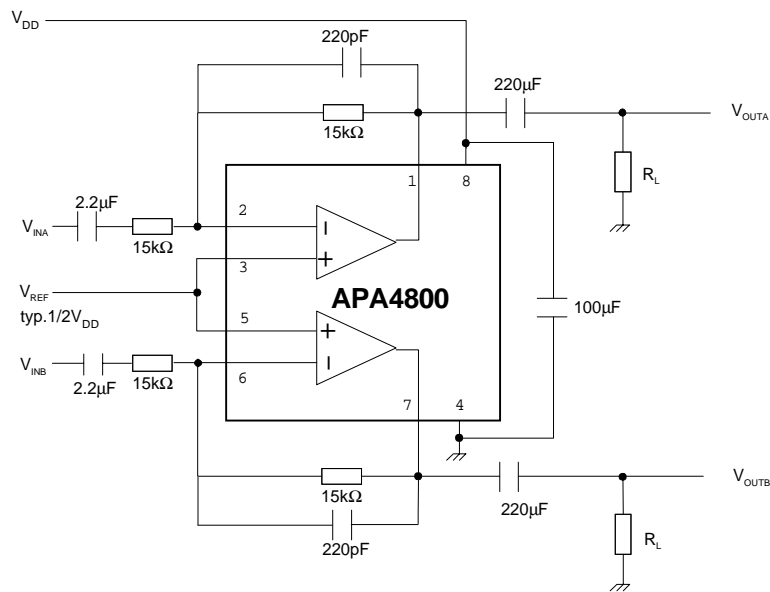

Typical Characteristics

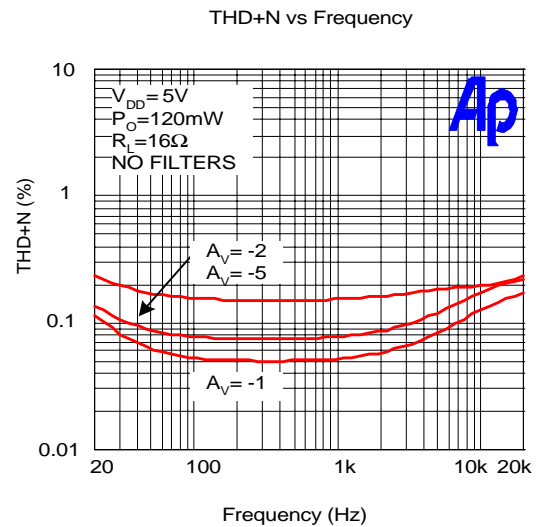
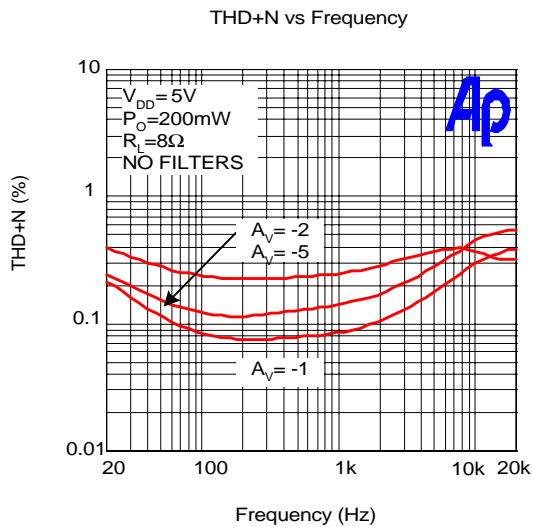
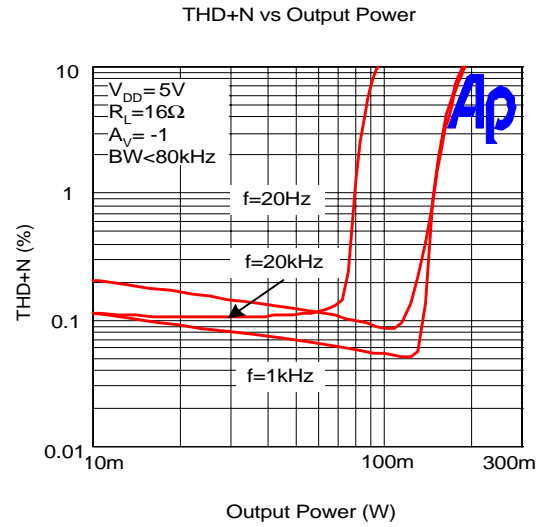
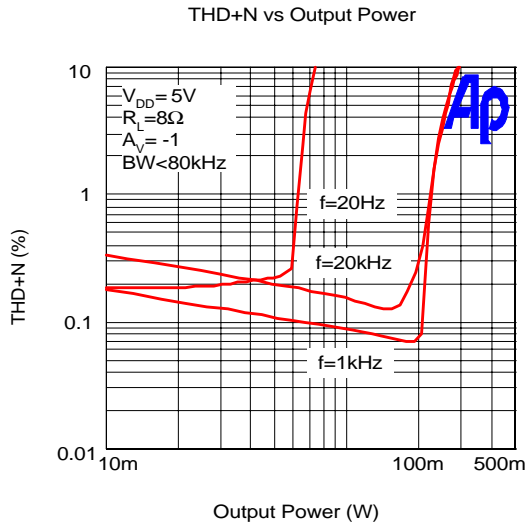

Typical Characteristics Cont.

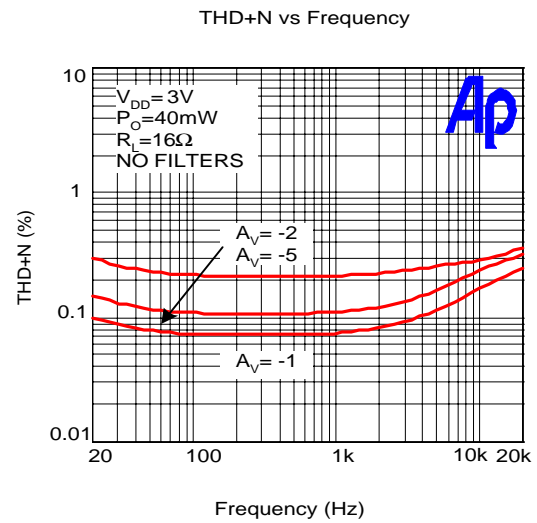
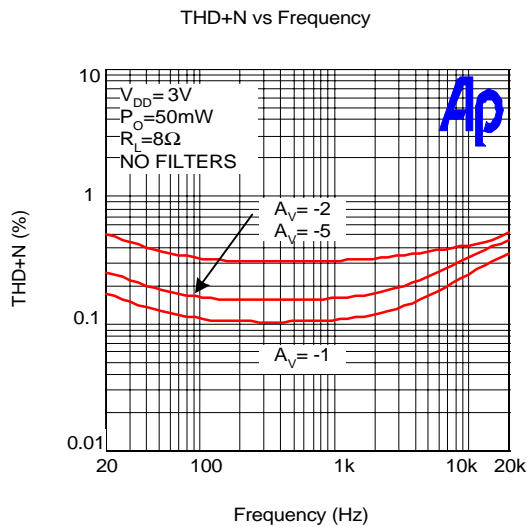
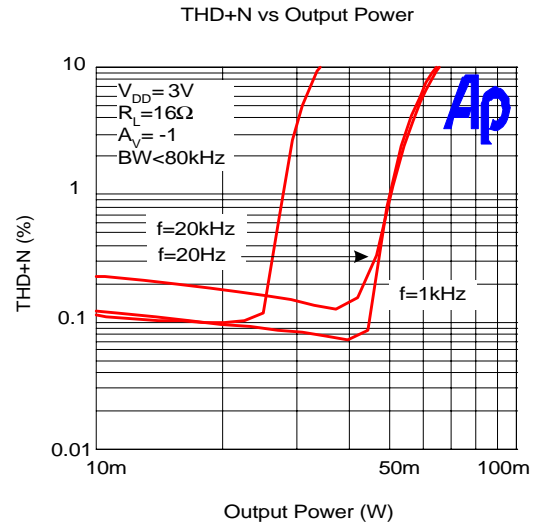
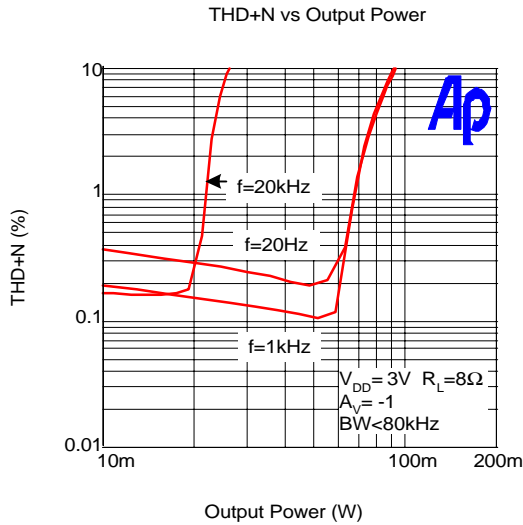

Typical Characteristics Cont.

Power Dissipation vs Output Power

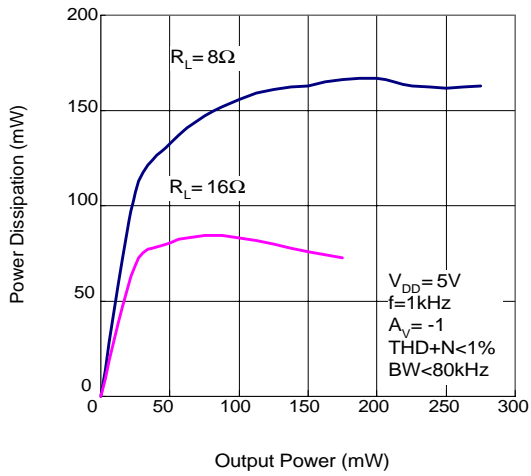

Power Dissipation vs Output Power

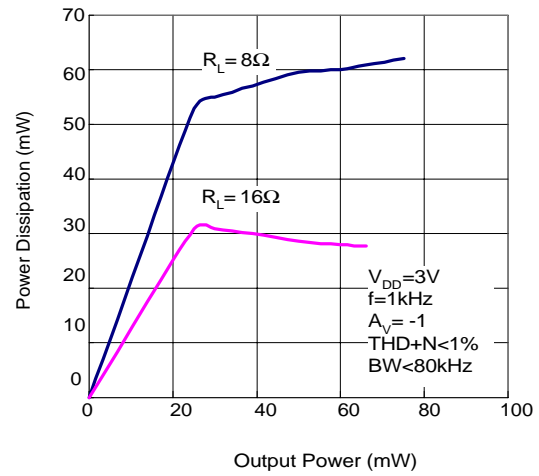

Supply Current vs Supply Voltage

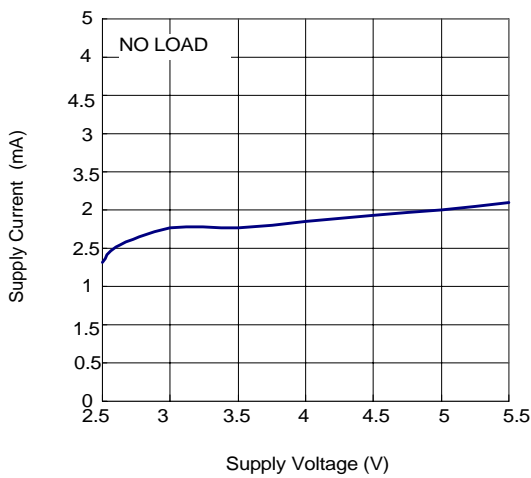

Open Loop Frequency Response

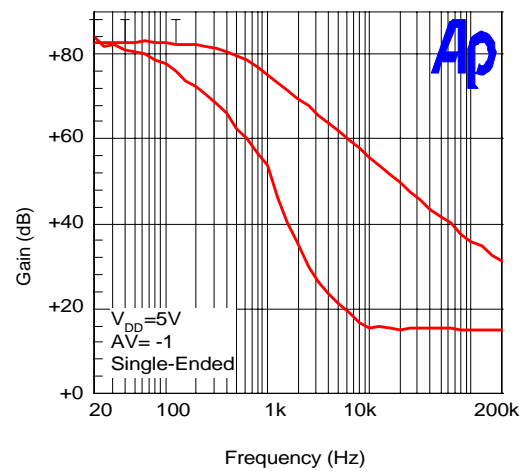

Typical Characteristics Cont.

Output Power vs Supply Voltage

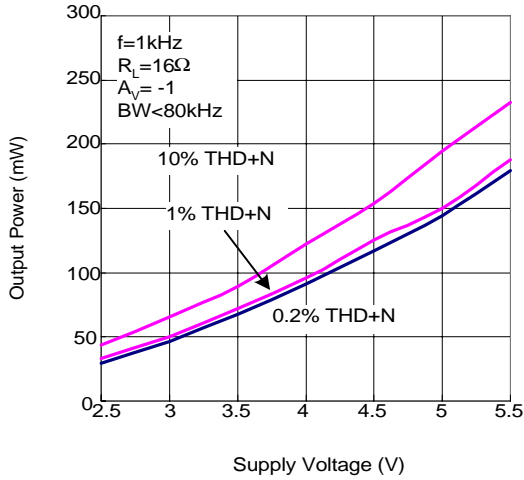

Output Power vs Supply Voltage

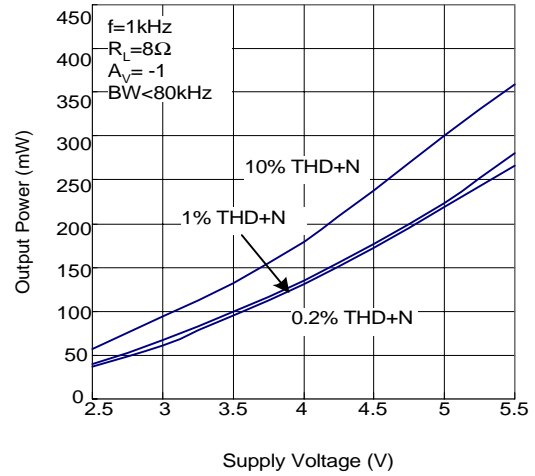

Output Power vs Load Resistance

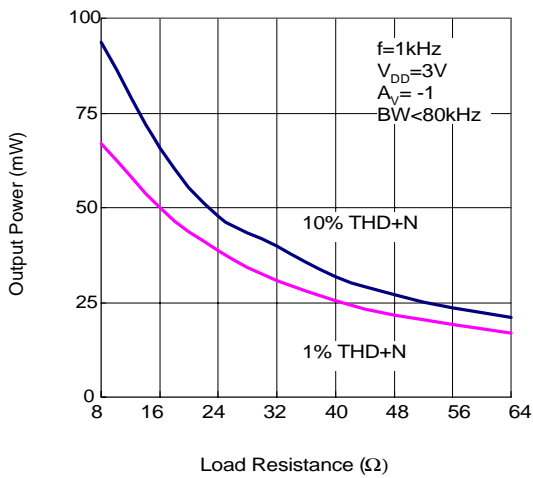

Output Power vs Load Resistance

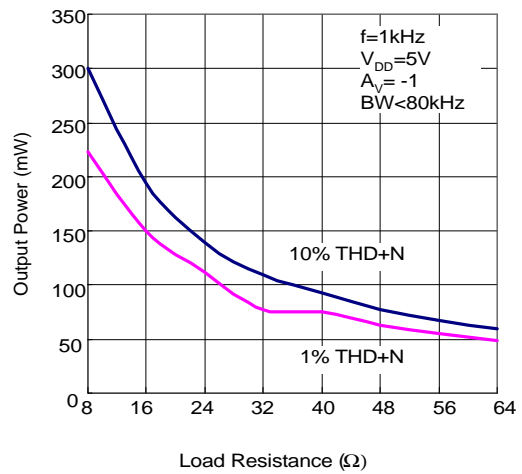

Typical Characteristics Cont.

Noise Floor

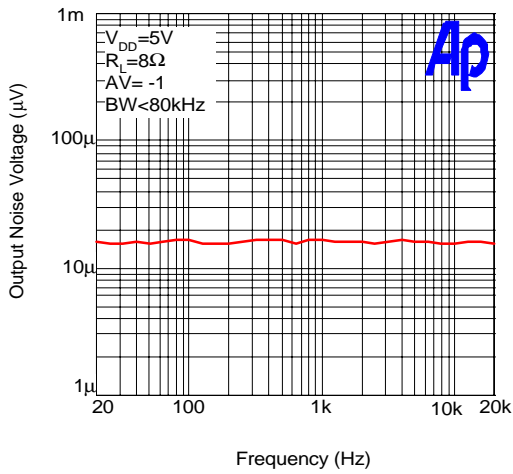

Channel Separation

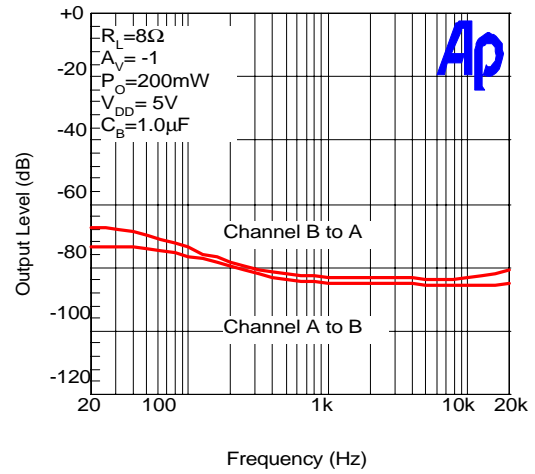

Power Supply Rejection Ratio

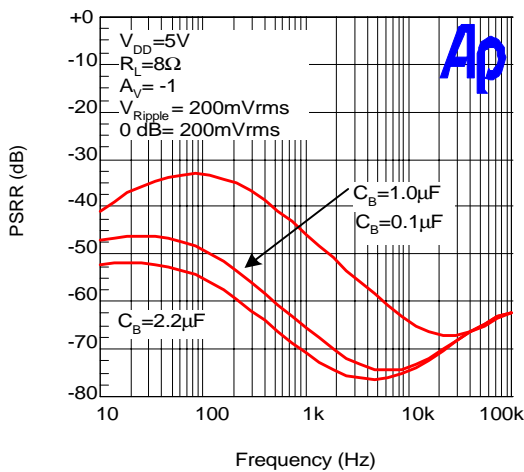

Typical Application Frequency Response

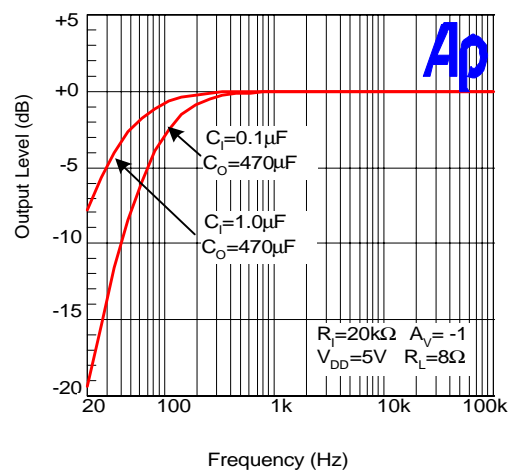

Typical Characteristics Cont.

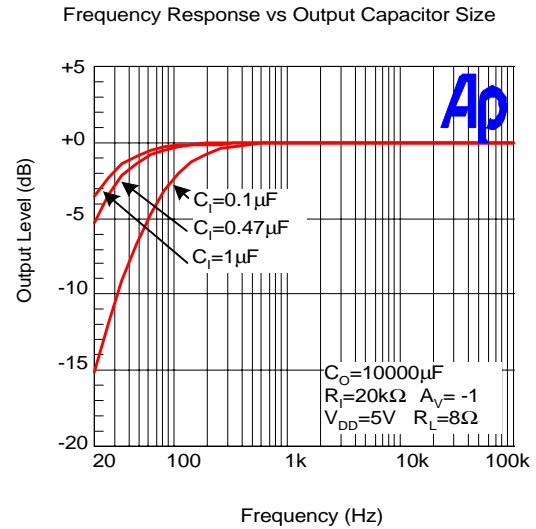
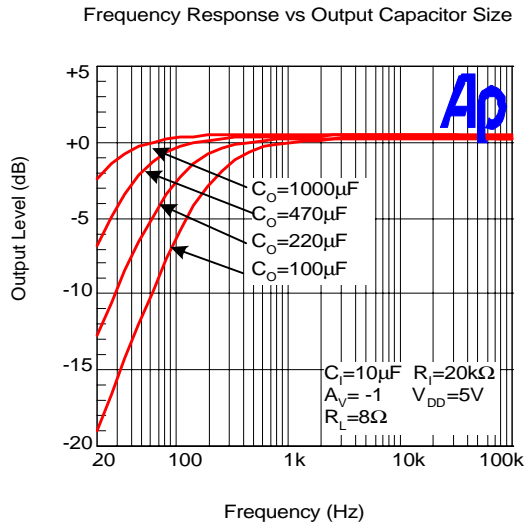

Customer Service

Anpec Electronics Corp.

Head Office :

5F, No. 2 Li-Hsin Road, SBIP,
 Hsin-Chu, Taiwan, R.O.C.
 Tel : 886-3-5642000
 Fax : 886-3-5642050

Taipei Branch :

7F, No. 137, Lane 235, Pac Chiao Rd.,
 Hsin Tien City, Taipei Hsien, Taiwan, R. O. C.
 Tel : 886-2-89191368
 Fax : 886-2-89191369

Packaging Information

PDIP-8 pin (Reference JEDEC Registration MS-001)

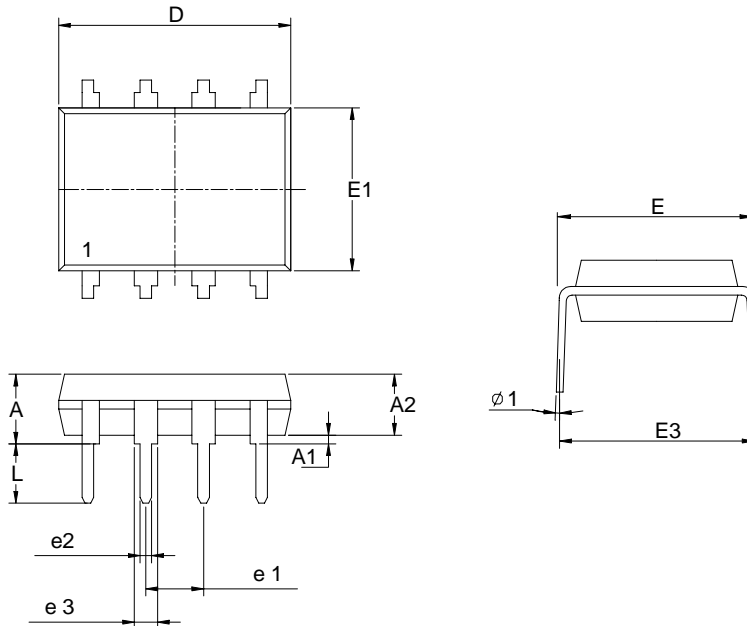

Dim	Millimeters		Inches	
	Min.	Max.	Min.	Max.
A		5.33		0.210
A1	0.38		0.015	
A2	2.92	3.68	0.115	0.145
D	9.02	10.16	0.355	0.400
e1	2.54BSC		0.100BSC	
e2	0.36	0.56	0.014	0.022
e3	1.14	1.78	0.045	0.070
E	7.62 BSC		0.300 BSC	
E1	6.10	7.11	0.240	0.280
E3		10.92		0.430
L	2.92	3.81	0.115	0.150
$\phi 1$	15°		15°	

Packaging Information

SOP-8 pin (Reference JEDEC Registration MS-012)

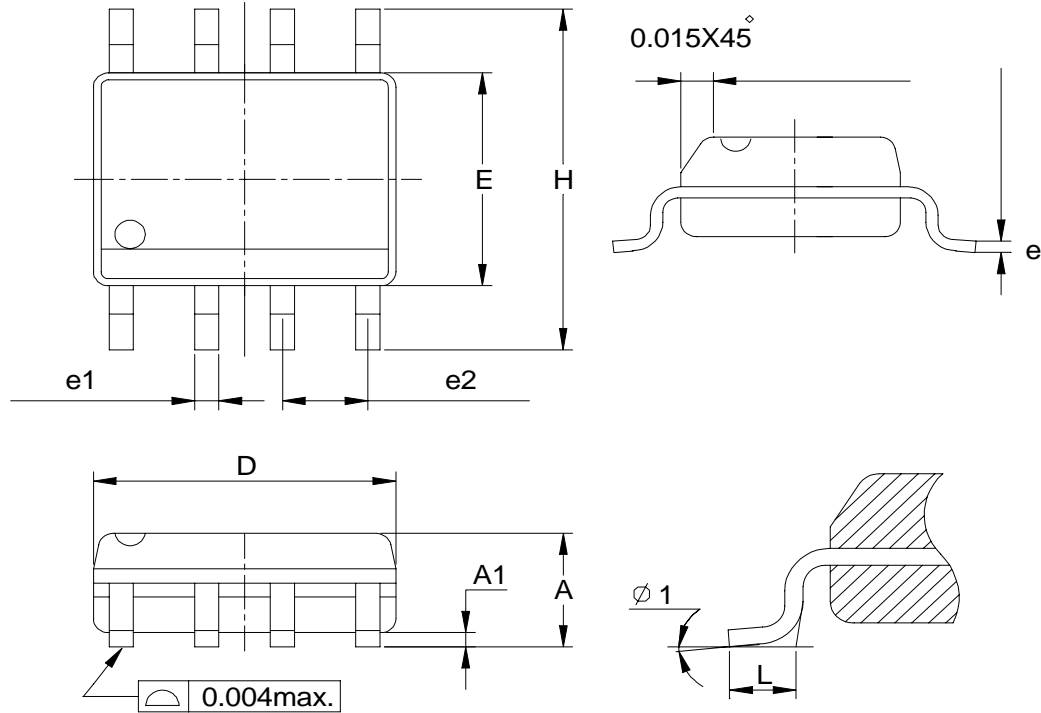

Dim	Millimeters		Inches	
	Min.	Max.	Min.	Max.
A	1.35	1.75	0.053	0.069
A1	0.10	0.25	0.004	0.010
D	4.80	5.00	0.189	0.197
E	3.80	4.00	0.150	0.157
H	5.80	6.20	0.228	0.244
L	0.40	1.27	0.016	0.050
e1	0.33	0.51	0.013	0.020
e2	1.27BSC		0.50BSC	
$\phi 1$	0°	8°	0°	8°

Physical Specifications

Terminal Material	Solder-Plated Copper (Solder Material : 90/10 or 63/37 SnPb)
Lead Solderability	Meets EIA Specification RSI86-91, ANSI/J-STD-002 Category 3.
Packaging	2500 devices per reel

Reflow Condition (IR/Convection or VPR Reflow)

Reference JEDEC Standard J-STD-020A APRIL 1999

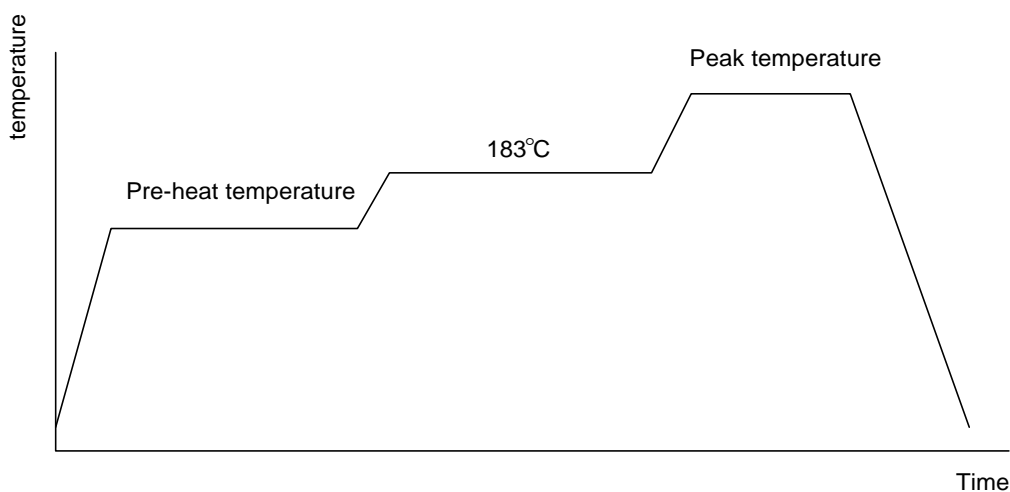

Classification Reflow Profiles

	Convection or IR/ Convection	VPR
Average ramp-up rate(183°C to Peak)	3°C/second max.	10 °C /second max.
Preheat temperature 125 ± 25°C)	120 seconds max	
Temperature maintained above 183°C	60 – 150 seconds	
Time within 5°C of actual peak temperature	10 –20 seconds	60 seconds
Peak temperature range	220 +5/-0°C or 235 +5/-0°C	215-219°C or 235 +5/-0°C
Ramp-down rate	6 °C /second max.	10 °C /second max.
Time 25°C to peak temperature	6 minutes max.	

Package Reflow Conditions

pkg. thickness ≥ 2.5mm and all bgas	pkg. thickness < 2.5mm and pkg. volume ≥ 350 mm ³	pkg. thickness < 2.5mm and pkg. volume < 350mm ³
Convection 220 +5/-0 °C		Convection 235 +5/-0 °C
VPR 215-219 °C		VPR 235 +5/-0 °C
IR/Convection 220 +5/-0 °C		IR/Convection 235 +5/-0 °C

Reliability test program

Test item	Method	Description
SOLDERABILITY	MIL-STD-883D-2003	245°C , 5 SEC
HOLT	MIL-STD-883D-1005.7	1000 Hrs Bias @ 125 °C
PCT	JESD-22-B, A102	168 Hrs, 100 % RH , 121°C
TST	MIL-STD-883D-1011.9	-65°C ~ 150°C, 200 Cycles
ESD	MIL-STD-883D-3015.7	VHBM > 2KV, VMM > 200V
Latch-Up	JESD 78	10ms , I _{tr} > 100mA

Carrier Tape & Reel Dimensions

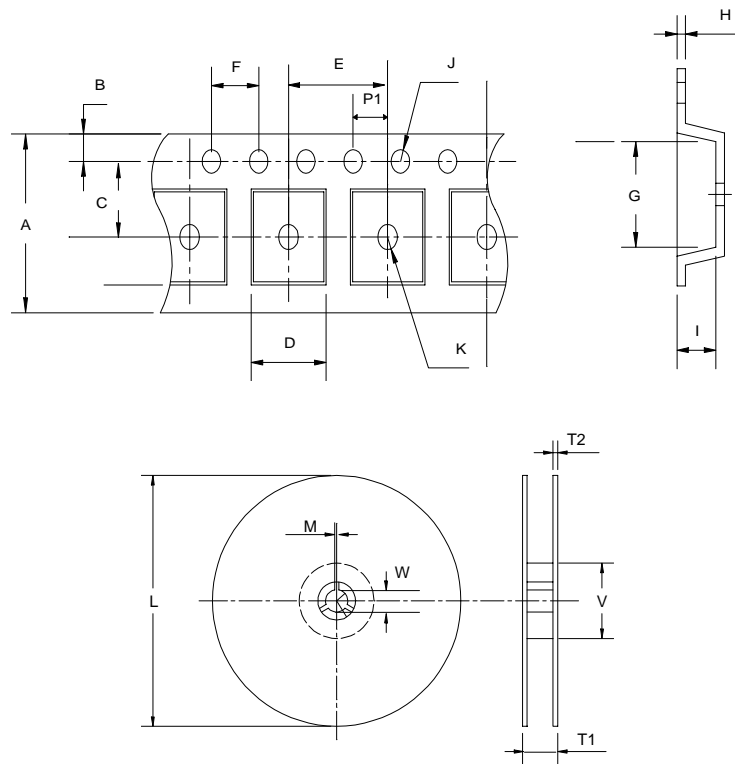

Application	A	E	B	C	J	K	F	P1	D
SOP 8N	12 + 0.3 12 - 0.1	8.0 ± 0.1	1.75± 0.1	5.5± 0.1	1.55± 0.1	1.5± 0.25	4.0 ± 0.1	2.0 ± 0.1	6.4 ± 0.1
Application	G	I	H	L	V	W	M	T1	T2
SOP 8N	5.2 ± 0.1	2.1 ± 0.1	0.3±0.013	330±1	100±1	13+0.5 13 -0.1	2.2±0.1	12.5± 0.5	2.0 ± 0.2

(mm)

Cover Tape Dimensions

Carrier Width	12
Cover Tape Width	9.3

(mm)