

1.5A Low Dropout Fast Response Positive Adjustable Regulator and Fixed
1.8V, 2.5V, 2.85V and 3.3V

Features

- Guaranteed Output Voltage Accuracy within 2%
- Fast Transient Response
- Guaranteed Dropout Voltage at Multiple Currents
- Load Regulation : 0.1% Typ.
- Line Regulation : 0.03% Typ.
- Low Dropout Voltage : 1.3V Typ. at $I_{OUT} = 1.5A$
- Current Limit : 1.5A Min. at $T_J = 125^{\circ}C$
- On-Chip Thermal Limiting : 150 °C Typ.
- Adjustable Output : 1.25~10.7V
- Standard 3-pin SOT-223, TO-252 , TO-220 and TO-263 Power Packages.

Applications

- Active SCSI Terminators
- Low Voltage Logic Supplies
- Battery-Powered Circuitry
- Post Regulator for Switching Power Supply

General Description

The APL1086 is a low dropout three-terminal adjustable regulators with 1.5A output current capability. In order to obtain lower dropout voltage and faster transient response, which is critical for low voltage applications , the APL1086 has been optimized.

The device is available in an adjustable version and fixed output voltages of 1.8V, 2.5V, 2.85V and 3.3V, the output available voltage range is from 1.25~10.7V with an input supply below 12V. Dropout voltage is guaranteed at a maximum of 1.45V at 1.5A.

Current limit is trimmed to ensure specified output current and controlled short-circuit current. On-chip thermal limiting provides protection against any combination of overload that would create excessive junction temperatures.

The APL1086 is available in the industry standard 3-pin SOT-223, TO-252, TO-220 or TO-263 power packages.

Pin Description

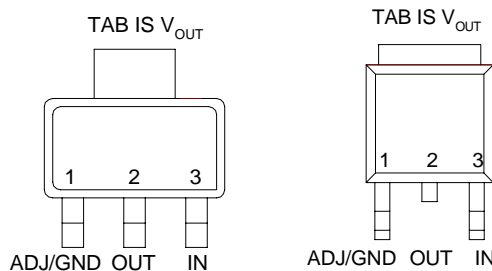

Front View for SOT-223

Front View for TO-252

ANPEC reserves the right to make changes to improve reliability or manufacturability without notice, and advise customers to obtain the latest version of relevant information to verify before placing orders.

Pin Description

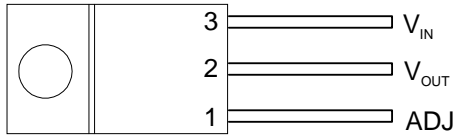



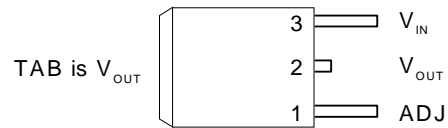



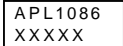

Front View for TO-220

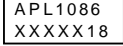

Front View for TO-263

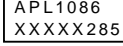
Ordering and Marking Information

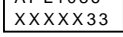
<p>APL1086- □□ □□ - □□</p> <p>□□□□ - Handling Code □□□□ - Temp. Range □□□□ - Package Code □□□□ - Voltage Code</p>	<p>Package Code F : TO-220 G : TO-263 U : TO-252 V : SOT-223</p> <p>Temp. Range C : 0 to 70 °C</p> <p>Handling Code TU : Tube TR : Tape & Reel</p> <p>Voltage Code 18 : 1.8V 25 : 2.5V 285 : 2.85V 33 : 3.3V Blank : Adjustable Version</p>
<p>APL1086 F/G/U :  XXXXX - Date Code</p>	<p>APL1086 V :  XXXXX - Date Code</p>
<p>APL1086 -18F/G/U :  XXXXX - Date Code</p>	<p>APL1086 -18V :  XXXXX - Date Code</p>
<p>APL1086 -25F/G/U :  XXXXX - Date Code</p>	<p>APL1086 -25V :  XXXXX - Date Code</p>
<p>APL1086 -285F/G/U :  XXXXX - Date Code</p>	<p>APL1086 -285V :  XXXXX - Date Code</p>
<p>APL1086 -33F/G/U :  XXXXX - Date Code</p>	<p>APL1086 -33V :  XXXXX - Date Code</p>

Absolute Maximum Ratings

Symbol	Parameter	Rating	Unit
V_i	Input Voltage	12	V
T_j	Operating Junction Temperature Range		°C
	Control Section	0 to 125	
	Power Transistor	0 to 150	
T_{STG}	Storage Temperature Range	-65 to +150	°C
T_L	Lead Temperature (Soldering, 10 second)	260	°C

Electrical Characteristics

Symbol	Parameter	Test Conditions	APL1086			Unit
			Min.	Typ.	Max.	
V_{REF}	Reference Voltage	$10mA \leq I_{OUT} \leq 1.5A, 1.4V \leq (V_{IN} - V_{OUT}) \leq 9.75V, T_J = 0 \sim 125^\circ C$	1.225	1.250	1.275	V
V_{OUT}	Output Voltage APL1086-18	$T_J = 25^\circ C, I_{OUT} = 0mA, T_J = 0 \sim 125^\circ C, 0 \leq I_{OUT} \leq 1.5A, 3.5V \leq V_{IN} \leq 9V,$	1.782 1.764	1.800 1.800	1.818 1.836	V
	APL1086-25	$T_J = 25^\circ C, I_{OUT} = 0mA, T_J = 0 \sim 125^\circ C, 0 \leq I_{OUT} \leq 1.5A, 4V \leq V_{IN} \leq 9V,$	2.475 2.450	2.500 2.500	2.525 2.550	
	APL1086-28	$T_J = 25^\circ C, I_{OUT} = 0mA, T_J = 0 \sim 125^\circ C, 0 \leq I_{OUT} \leq 1.5A, 4.25V \leq V_{IN} \leq 9V,$	2.822 2.792	2.850 2.850	2.878 2.910	
	APL1086-33	$T_J = 25^\circ C, I_{OUT} = 0mA, T_J = 0 \sim 125^\circ C, 0 \leq I_{OUT} \leq 1.5A, 4.75V \leq V_{IN} \leq 9V,$	3.267 3.235	3.300 3.300	3.333 3.365	
REG_{LINE}	Line Regulation APL1086	$T_J = 0 \sim 125^\circ C, I_{OUT} = 10mA, 1.5V \leq V_{IN} - V_{OUT} \leq 9V, (note 1)$		0.03	0.2	% mV
	APL1086-18	$I_{OUT} = 0mA, 3.5V \leq V_{IN} \leq 9V, (note 1)$		1	6	
	APL1086-25	$I_{OUT} = 0mA, 4V \leq V_{IN} \leq 9V, (note 1)$		1	6	
	APL1086-28	$I_{OUT} = 0mA, 4.25V \leq V_{IN} \leq 9V, (note 1)$		1	6	
	APL1086-33	$I_{OUT} = 0mA, 4.75V \leq V_{IN} \leq 9V, (note 1)$		1	6	
REG_{LOAD}	Load Regulation APL1086	$T_J = 0 \sim 125^\circ C, (V_{IN} - V_{OUT}) = 3V, 0 \leq I_{OUT} \leq 1.5A, (note 1)$		0.1	0.4	% mV
	APL1086-18	$V_{IN} = 3.5V, 0 \leq I_{OUT} \leq 1.5A, (note 1)$		1	10	
	APL1086-25	$V_{IN} = 4V, 0 \leq I_{OUT} \leq 1.5A, (note 1)$		1	10	
	APL1086-28	$V_{IN} = 4.25V, 0 \leq I_{OUT} \leq 1.5A, (note 1)$		1	10	
	APL1086-33	$V_{IN} = 4.75V, 0 \leq I_{OUT} \leq 1.5A, (note 1)$		1	10	
V_D	Dropout Voltage	$I_{OUT} = 1.5A, T_J = 0 \sim 125^\circ C$		1.3	1.45	V
I_{LIMIT}	Current Limit	$(V_{IN} - V_{OUT}) = 5V, T_J = 25^\circ C$	1500			mA
I_{ADJ}	Adjust Pin Current	$(V_{IN} - V_{OUT}) = 3V, I_{OUT} = 10mA, T_J = 0 \sim 125^\circ C$		60	120	μA
ΔI_{ADJ}	Adjust Pin Current Change	$T_J = 0 \sim 125^\circ C, 10mA \leq I_{OUT} \leq 1.5A, 1.4V \leq (V_{IN} - V_{OUT}) \leq 7.75V$		0.2	5	μA
I_o	Minimum Load Current	$T_J = 0 \sim 125^\circ C, (V_{IN} - V_{OUT}) = 7.75V, (note 3)$		1.7		mA
PSRR	Ripple Rejection	$F_{RIPPLE} = 120Hz, V_{RIPPLE} = 1V_{P-P}, (V_{IN} - V_{OUT}) = 3V, T_J = 0 \sim 125^\circ C$	60	75		dB
T_R	Thermal Regulation	$T_J = 25^\circ C, 30ms$ Pulse		0.01	0.02	%/W
T_S	Temperature Stability			0.5		%
L_S	Long -Term Stability	$T_J = 125^\circ C, 1000Hrs.$		0.3		%

Electrical Characteristics (Cont.)

Symbol	Parameter	Test Conditions	APL1086			Unit
			Min.	Typ.	Max.	
V_N	RMS Output Noise	$T_J=25^{\circ}\text{C}, 10\text{Hz}\leq F\leq 10\text{kHz}, (\% \text{ of } V_{OUT})$		0.003		%
θ_{th}	Thermal Resistance	Junction to Case, at Tab Junction to ambient		15 50		$^{\circ}\text{C}/\text{W}$
OT	Over Temperature Point			150		$^{\circ}\text{C}$
	Quiescent Current	$T_J=0\sim 125^{\circ}\text{C},$ APL1086-18 $V_{IN}\leq 9\text{V}$		5.5	10	mA
		APL1086-25 $V_{IN}\leq 9\text{V}$		5.5	10	
		APL1086-28 $V_{IN}\leq 9\text{V}$		5.5	10	
		APL1086-33 $V_{IN}\leq 9\text{V}$		5.5	10	

Note 1: See thermal regulation specifications for changes in output voltage due to heating effects. Load line regulations are measured at a constant junction temperature by low duty cycle pulse testing.

Note 2: Dropout voltage is specified over the full output current range of the device. Dropout voltage is defined as the minimum input/output differential measured at the specified output current. Test points and limits are also shown on the Dropout Voltage curve.

Note 3: Minimum load current is defined as the minimum output current required to maintain regulation.

Application Circuits

1.25V to 10.7V Adjustable Regulator

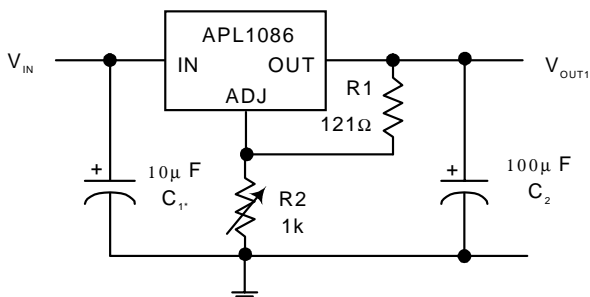

* Needed if device is far from filter capacitors

$$V_{OUT} = 1.250V \times \frac{R1 + R2}{R1}$$

Improving Ripple Rejection

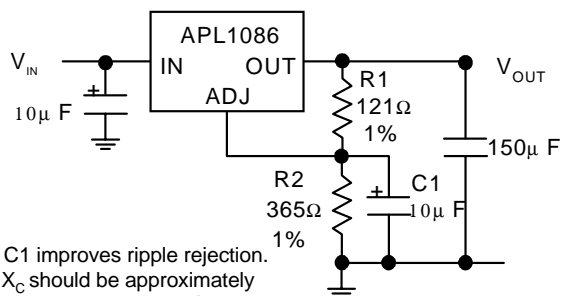

* C1 improves ripple rejection. X_C should be approximately equal to R1 at ripple frequency

5V Regulator with Shutdown

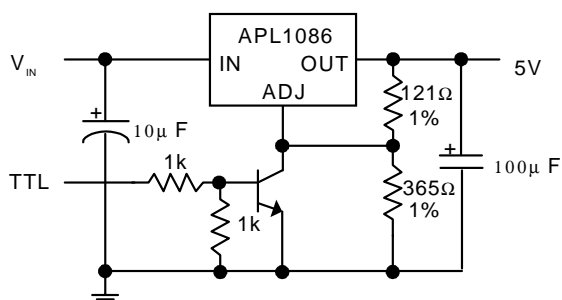

Typical Characteristics

Load Transient Response

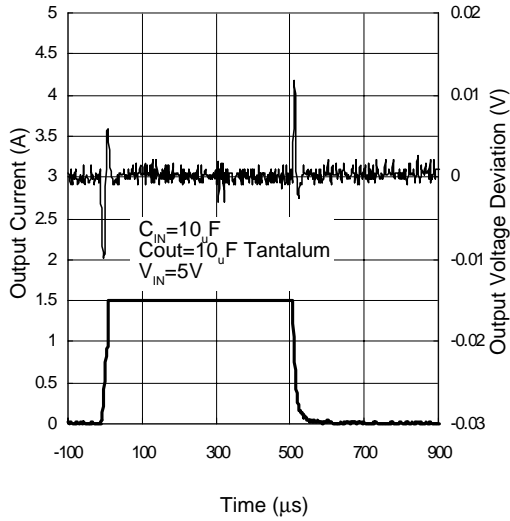

Line Transient Response

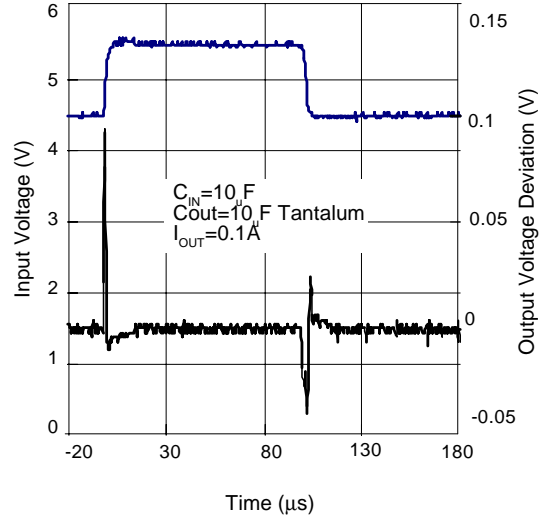

Dropout Voltage vs. Output Current

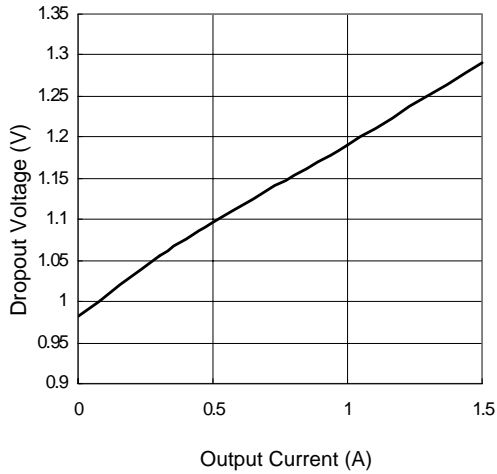

Output Voltage vs. Input Voltage

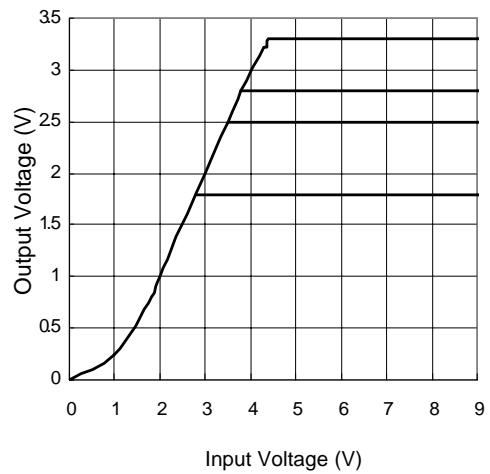

Typical Characteristics Cont.

Input Current vs. Input Voltage

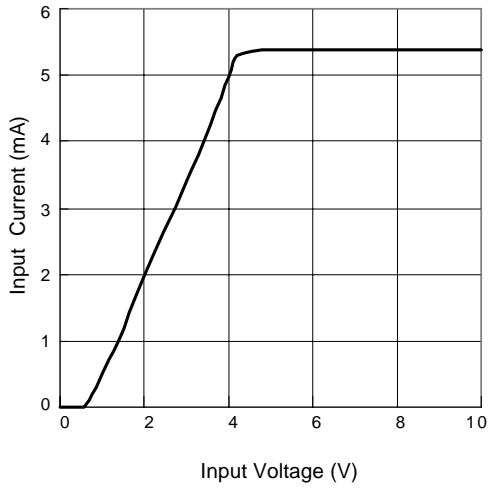

Current Limit vs. Input Voltage

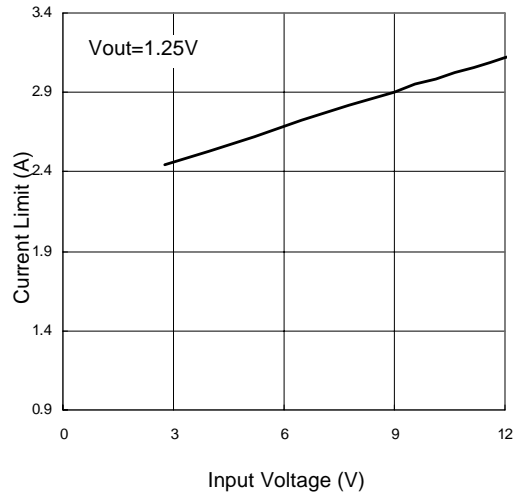

Output Voltage vs. Temperature

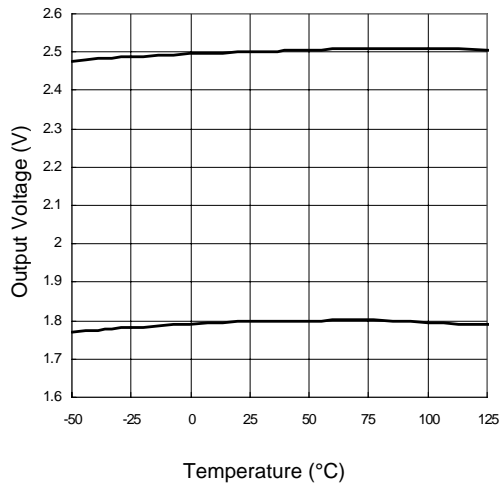

Output Voltage vs. Temperature

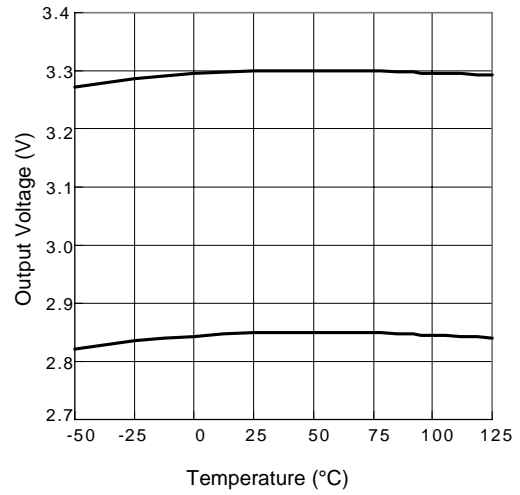

Typical Characteristics Cont.

Adjustable Pin Current vs. Temperature

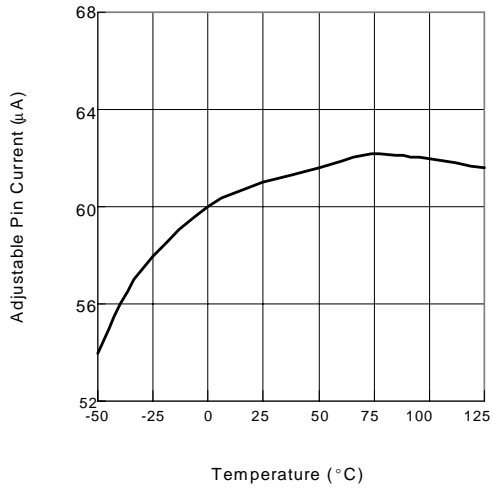

Input Current vs. Temperature

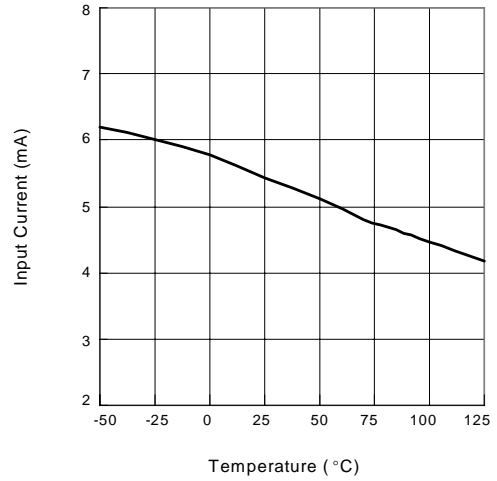

Current Limit vs. Temperature

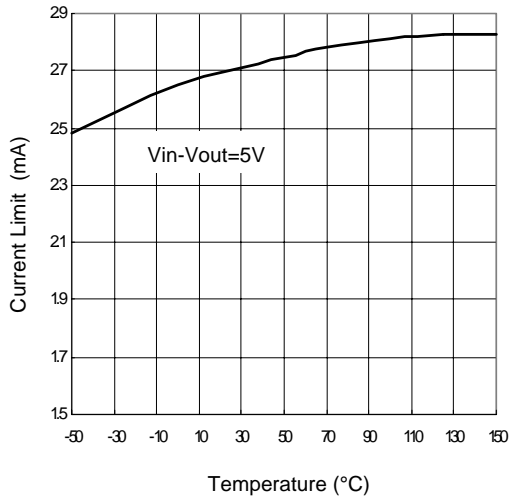

Package Information

SOT-223(Reference JEDEC Registration SOT-223)

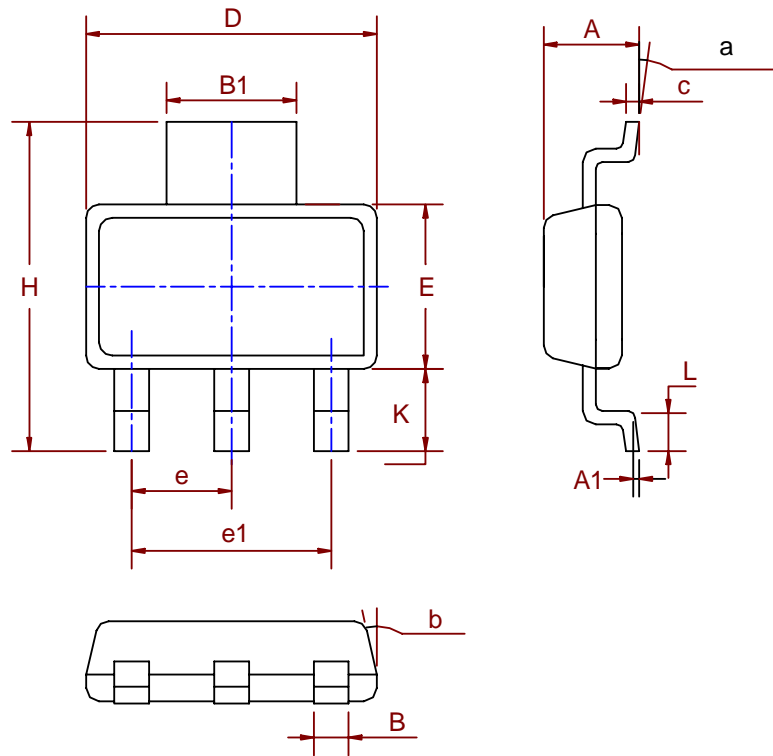

Dim	Millimeters		Inches	
	Min.	Max.	Min.	Max.
A	1.50	1.80	0.06	0.07
A1	0.02	0.08		
B	0.60	0.80	0.02	0.03
B1	2.90	3.10	0.11	0.12
c	0.28	0.32	0.01	0.01
D	6.30	6.70	0.25	0.26
E	3.30	3.70	0.13	0.15
e	2.3 BSC		0.09 BSC	
e1	4.6 BSC		0.18 BSC	
H	6.70	7.30	0.26	0.29
L	0.91	1.10	0.04	0.04
K	1.50	2.00	0.06	0.08
α	0°	10°	0°	10°
β	13°		13°	

Package Informaion

TO-252(Reference JEDEC Registration TO-252)

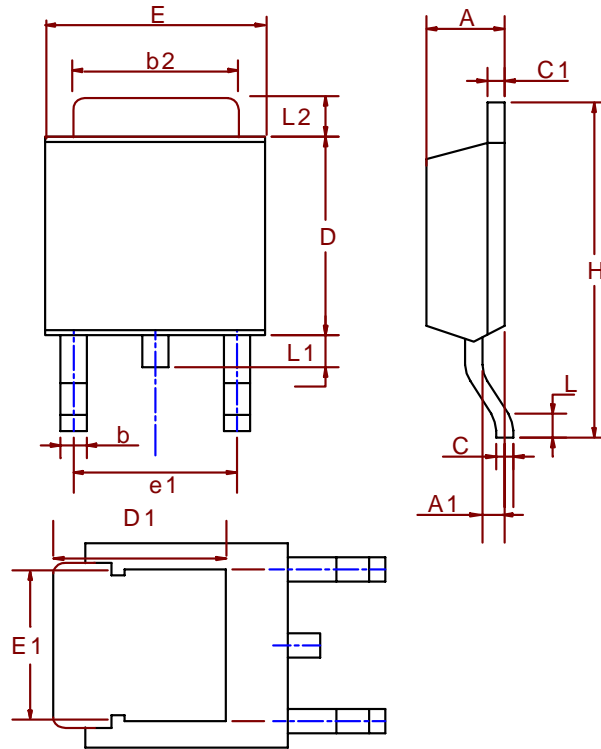

Dim	Millimeters		Inches	
	Min.	Max.	Min.	Max.
A	2.18	2.39	0.086	0.094
A1	0.89	1.27	0.035	0.050
b	0.508	0.89	0.020	0.035
b2	5.207	5.461	0.205	0.215
C	0.46	0.58	0.018	0.023
C1	0.46	0.58	0.018	0.023
D	5.334	6.22	0.210	0.245
D1	5.2 REF		0.205 REF	
E	6.35	6.73	0.250	0.265
E1	5.3 REF		0.209 REF	
e1	3.96	5.18	0.156	0.204
H	9.398	10.41	0.370	0.410
L	0.51		0.020	
L1	0.64	1.02	0.025	0.040
L2	0.89	2.032	0.035	0.080

Package Informaion

TO-220 (Reference JEDEC Registration TO-220)

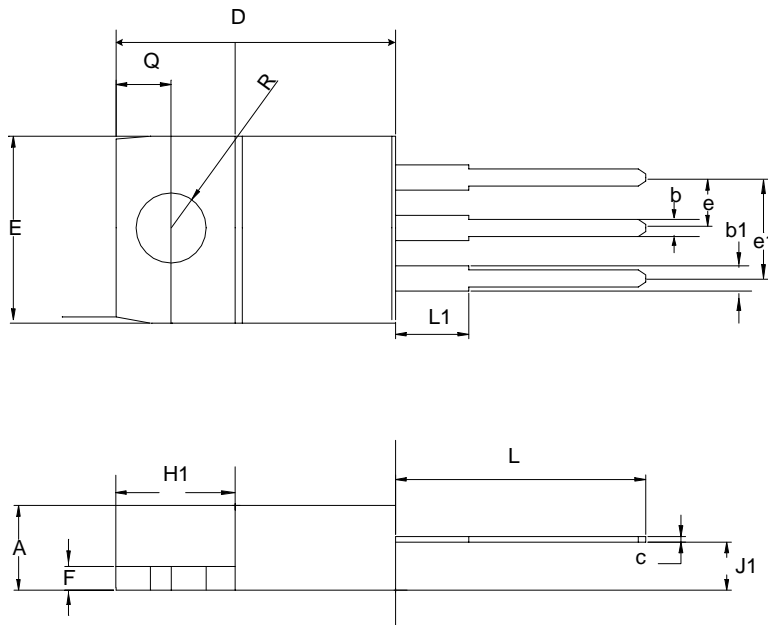

Dim	Millimeters		Inches	
	Min.	Max.	Min.	Max.
A	3.56	4.83	0.140	0.190
b1	1.14	1.78	0.045	0.070
b	0.51	1.14	0.020	0.045
c	0.31	1.14	0.012	0.045
D	14.23	16.51	0.560	0.650
e	2.29	2.79	0.090	0.110
e1	4.83	5.33	0.190	0.210
E	9.65	10.67	0.380	0.420
F	0.51	1.40	0.020	0.055
H1	5.84	6.86	0.230	0.270
J1	2.03	2.92	0.080	0.115
L	12.7	14.73	0.500	0.580
L1	3.65	6.35	0.143	0.250
R	3.53	4.09	0.139	0.161
Q	2.54	3.43	0.100	0.135

Package Informaion

TO-263 (Reference JEDEC Registration TO-263)

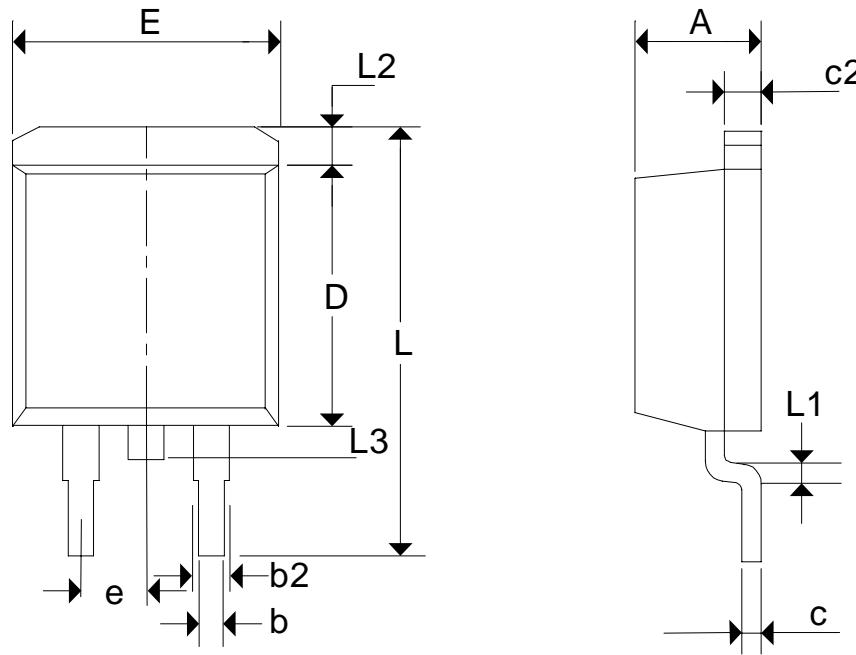

Dim	Millimeters		Inches	
	Min.	Max.	Min.	Max.
A	4.06	4.83	0.160	0.190
b	0.51	0.992	0.02	0.039
b2	1.14	1.399	0.045	0.055
c	0.38 TYP.		0.015 TYP.	
c2	1.14	1.40	0.045	0.055
D	8.64	9.65	0.340	0.380
E	9.66	10.299	0.380	0.405
e	2.543 BSC.		0.100 BSC.	
L	14.60	15.88	0.575	0.625
L1	2.24	2.84	0.090	0.110
L2	-	2.92	-	0.115
L3	1.20	1.78	0.050	0.070

Physical Specifications

Terminal Material	Solder-Plated Copper (Solder Material : 90/10 or 63/37 SnPb)
Lead Solderability	Meets EIA Specification RSI86-91, ANSI/J-STD-002 Category 3.

Reflow Condition (IR/Convection or VPR Reflow)

Reference JEDEC Standard J-STD-020A APRIL 1999

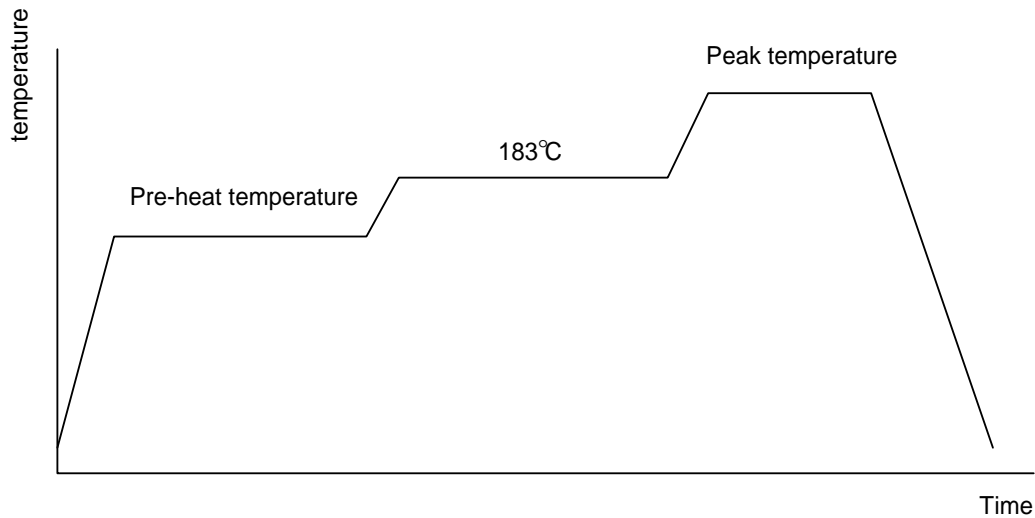

Classification Reflow Profiles

	Convection or IR/ Convection	VPR
Average ramp-up rate(183°C to Peak)	3°C/second max.	10 °C /second max.
Preheat temperature 125 ± 25°C)	120 seconds max	
Temperature maintained above 183°C	60 – 150 seconds	
Time within 5°C of actual peak temperature	10 – 20 seconds	60 seconds
Peak temperature range	220 +5/-0°C or 235 +5/-0°C	215-219°C or 235 +5/-0°C
Ramp-down rate	6 °C /second max.	10 °C /second max.
Time 25°C to peak temperature	6 minutes max.	

Package Reflow Conditions

pkg. thickness ≥ 2.5mm and all bgas	pkg. thickness < 2.5mm and pkg. volume ≥ 350 mm ³	pkg. thickness < 2.5mm and pkg. volume < 350mm ³
Convection 220 +5/-0 °C		Convection 235 +5/-0 °C
VPR 215-219 °C		VPR 235 +5/-0 °C
IR/Convection 220 +5/-0 °C		IR/Convection 235 +5/-0 °C

Reliability test program

Test item	Method	Description
SOLDERABILITY	MIL-STD-883D-2003	245°C , 5 SEC
HOLT	MIL-STD-883D-1005.7	1000 Hrs Bias @ 125 °C
PCT	JESD-22-B, A102	168 Hrs, 100 % RH , 121°C
TST	MIL-STD-883D-1011.9	-65°C ~ 150°C, 200 Cycles
ESD	MIL-STD-883D-3015.7	VHBM > 2KV, VMM > 200V
Latch-Up	JESD 78	10ms , I _{tr} > 100mA

Carrier Tape & Reel Dimensions

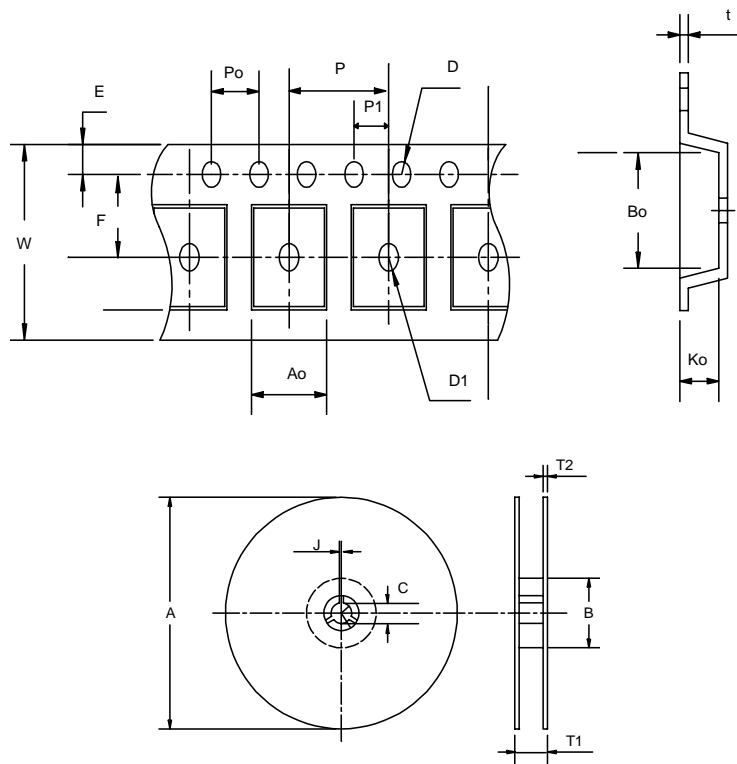

Application	A	B	C	J	T1	T2	W	P	E
TO-252	330 ± 3	100 ± 2	13 ± 0.5	2 ± 0.5	16.4 +0.3 -0.2	2.5 ± 0.5	16 +0.3 -0.1	8 ± 0.1	1.75 ± 0.1
	F	D	D1	Po	P1	Ao	Bo	Ko	t
	7.5 ± 0.1	1.5 +0.1	1.5 ± 0.25	4.0 ± 0.1	2.0 ± 0.1	6.8 ± 0.1	10.4 ± 0.1	2.5 ± 0.1	0.3 ± 0.05
Application	A	B	C	J	T1	T2	W	P	E
TO-263	380 ± 3	80 ± 2	13 ± 0.5	2 ± 0.5	24 ± 4	2 ± 0.3	24 +0.3 -0.1	16 ± 0.1	1.75 ± 0.1
	F	D	D1	Po	P1	Ao	Bo	Ko	t
	11.5 ± 0.1	1.5 +0.1	1.5 ± 0.25	4.0 ± 0.1	2.0 ± 0.1	10.8 ± 0.1	16.1 ± 0.1	5.2 ± 0.1	0.35 ± 0.01 3

(mm)

Reel Dimensions (Cont.)

Application	A	B	C	J	T1	T2	W	P	E
SOT-223	330±1	62±1.5	12.75±0.15	2 ± 0.6	12.4 +0.2	2± 0.2	12 ± 0.3	8 ± 0.1	1.75± 0.1
	F	D	D1	Po	P1	Ao	Bo	Ko	t
	5.5 ± 0.05	1.5+ 0.1	1.5+ 0.1	4.0 ± 0.1	2.0 ± 0.05	6.9 ± 0.1	7.5± 0.1	2.1± 0.1	0.3±0.05

(mm)

Cover Tape Dimensions

Application	Carrier Width	Cover Tape Width	Devices Per Reel
TO- 252	16	13.3	2500
TO- 263	24	21.3	1000
SOT- 223	12	9.3	2500

Customer Service

Anpec Electronics Corp.

Head Office :

5F, No. 2 Li-Hsin Road, SBIP,

Hsin-Chu, Taiwan, R.O.C.

Tel : 886-3-5642000

Fax : 886-3-5642050

Taipei Branch :

7F, No. 137, Lane 235, Pac Chiao Rd.,

Hsin Tien City, Taipei Hsien, Taiwan, R. O. C.

Tel : 886-2-89191368

Fax : 886-2-89191369