

Three-Terminal Low Current Positive Voltage Regulator

Features

- 3-Terminal Regulators
- Maximum Input Voltage : 30V
- Output Voltages of 5V,12V
- Output Current Up to 100mA
- No External Components
- Internal Thermal Overload Protection
- Internal Short-Circuit Limiting
- Output Voltage Offered in 4% tolerance
- SOP-8, SOT-89 and TO-92 Packages.

Applications

- Battery-Powered Circuitry
- Post Regulator for Switching Power Supply

General Description

This series of fixed-voltage monolithic integrated-circuit voltage regulators is designed for a wide range of applications. These applications include on-card regulation for elimination of noise and distribution problems associated with single-point regulation. In addition, they can be used with power-pass elements to make high-current voltage regulators. Each of these regulators can deliver up to 100mA of output current. The internal limiting and ternal shutdown features of these regulators make them essentially immune to overload. When used as a replacement for a Zener diode-resistor combination, an effective improvement in output impedance can be obtained together with lower-bias current.

Pin Description

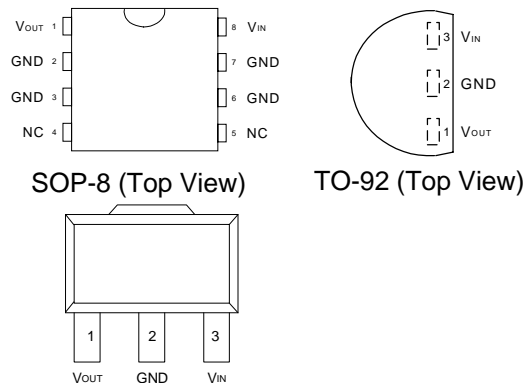

Ordering and Marking Information SOT-89 (Front View)

<p>APL78L05/12 - □□-□□</p> <p style="margin-left: 40px;"> □□ Handling Code □□ Temp. Range □□ Package Code </p>	<p>Package Code E : TO-92 K : SOP-8 D : SOT-89</p> <p>Temp. Range C : 0 to 70 °C</p> <p>Handling Code TU : Tube TR : Tape & Reel</p>
<p>APL78L05/12 E : APL 78L05/12 XXXXX XXXXX - Date Code</p>	<p>APL78L05/12 D/K : APL78L05/12 XXXXX XXXXX - Date Code</p>

ANPEC reserves the right to make changes to improve reliability or manufacturability without notice, and advise customers to obtain the latest version of relevant information to verify before placing orders.

Absolute Maximum Ratings

Symbol	Parameter	Rating	Unit
V_{IN}	Input Voltage	30	V_{DC}
T_J	Operating Junction Temperature Range Control Section Power Transistor	0 to 125 0 to 150	$^{\circ}C$
T_{STG}	Storage Temperature Range	-65 to +150	$^{\circ}C$
θ_{JA}	Thermal Resistance from Junction to Ambient in Free Air SOP-8 SOT-89/TO-92	160 180	$^{\circ}C/W$

Electrical Characteristics

$V_{IN}=10V$, $I_{OUT}=40mA$, $T_J=25^{\circ}C$, $C_{IN}=0.33\mu F$, $C_{OUT}=0.1\mu F$, unless otherwise specified

Symbol	Parameter	Test Condition	APL78L05			Unit
			Min.	Typ.	Max.	
V_O	Output Voltage		4.8	5.0	5.2	Vdc
V_O	Output Voltage (0° to $+125^{\circ}C$)	$1.0mA \leq I_{OUT} \leq 40mA$	4.75	5	5.25	Vdc
		$7.0Vdc \leq V_{IN} \leq 20Vdc$				
		$V_{IN}=10V$, $1.0mA \leq I_{OUT} \leq 40mA$				
Reg_{line}	Line Regulation	$7.0Vdc \leq V_{IN} \leq 20Vdc$		29	150	mV
		$8.0Vdc \leq V_{IN} \leq 20Vdc$		26	100	
Reg_{load}	Load Regulation	$1.0mA \leq I_{OUT} \leq 100mA$		9	60	mV
		$1.0mA \leq I_{OUT} \leq 40mA$		5	30	
I_B	Quiescent Current			2.8	6.0	mA
ΔI_B	Quiescent Current Change	$8.0Vdc \leq V_{IN} \leq 20Vdc$		0.15	1.5	mA
		$1.0mA \leq I_{OUT} \leq 40mA$		0.08	0.1	
$V_{IN}-V_O$	Dropout Voltage	$I_{OUT}=100mA$		1.9		Vdc

Symbol	Parameter	Test Condition	APL78L12			Unit
			Min.	Typ.	Max.	
V_O	Output Voltage		11.5	12	12.5	Vdc
V_O	Output Voltage (0° to $+125^{\circ}C$)	$1.0mA \leq I_{OUT} \leq 40mA$	11.4	12	12.6	Vdc
		$14Vdc \leq V_{IN} \leq 27Vdc$				
		$V_{IN}=19V$, $1.0mA \leq I_{OUT} \leq 40mA$				
Reg_{line}	Line Regulation	$14.5Vdc \leq V_{IN} \leq 27Vdc$			250	mV
Reg_{load}	Load Regulation	$1.0mA \leq I_{OUT} \leq 100mA$			100	mV
		$1.0mA \leq I_{OUT} \leq 40mA$			50	
I_B	Quiescent Current				6.5	mA
ΔI_B	Quiescent Current Change	$16Vdc \leq V_{IN} \leq 27Vdc$			1.5	mA
		$1.0mA \leq I_{OUT} \leq 40mA$				
$V_{IN}-V_O$	Dropout Voltage	$I_{OUT}=100mA$		1.9		Vdc

Application Circuit

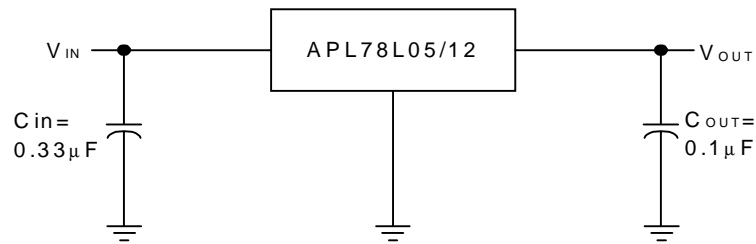

Note1 : A common ground is required between the input and the output voltage. The input voltage must remain typically 2V above the output voltage even during the low point on the input ripple voltage.

Note2 : C_{in} is required if regulator is located an appreciable distance from power supply filter.

Note3 : C_{OUT} is not needed for stability; however, it does improve transient response.

Typical Characteristics

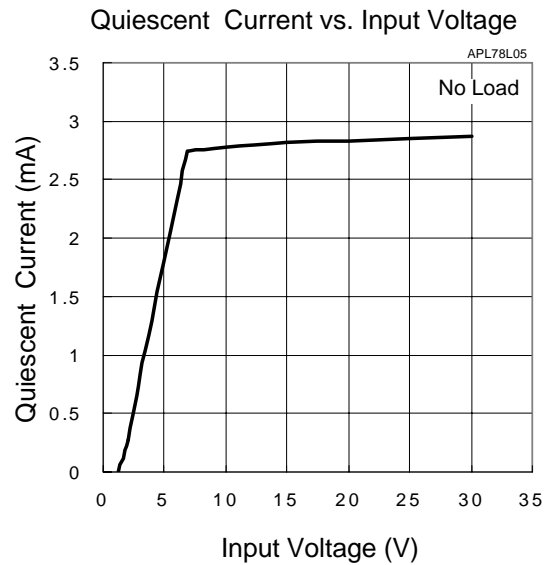
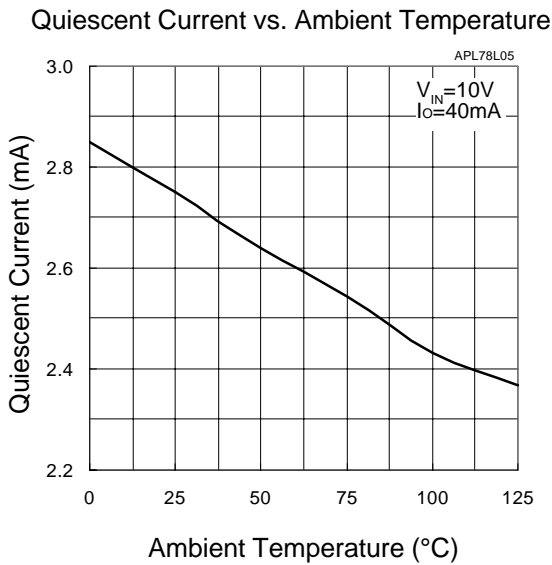
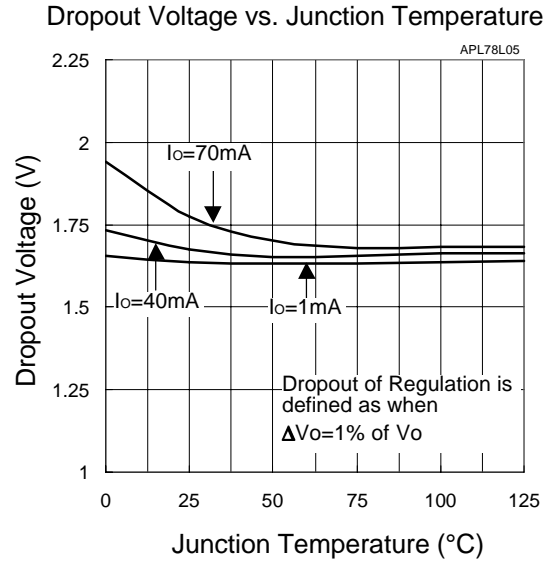
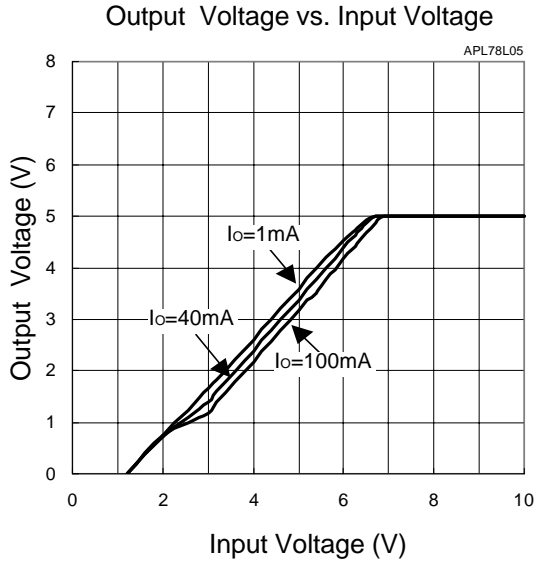

Typical Characteristics (Cont.)

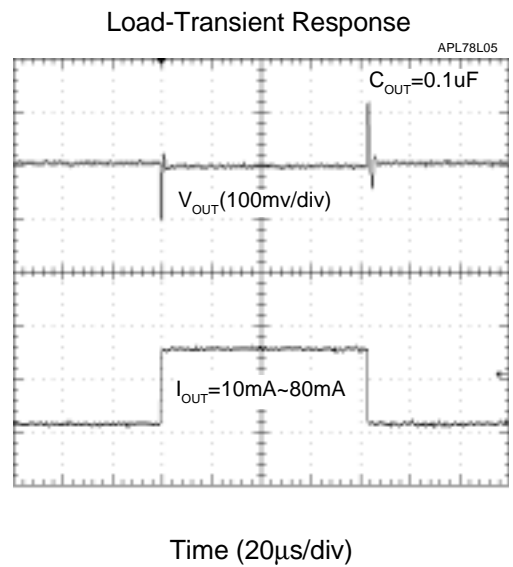
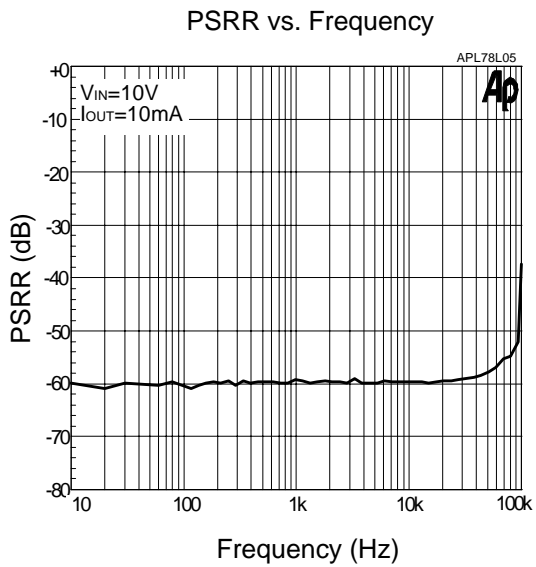
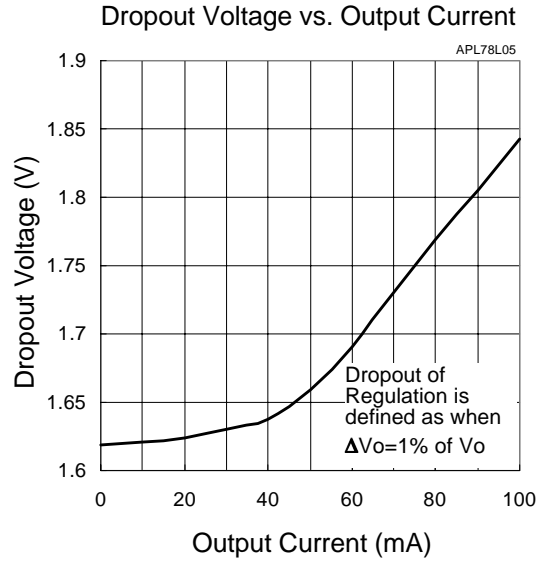
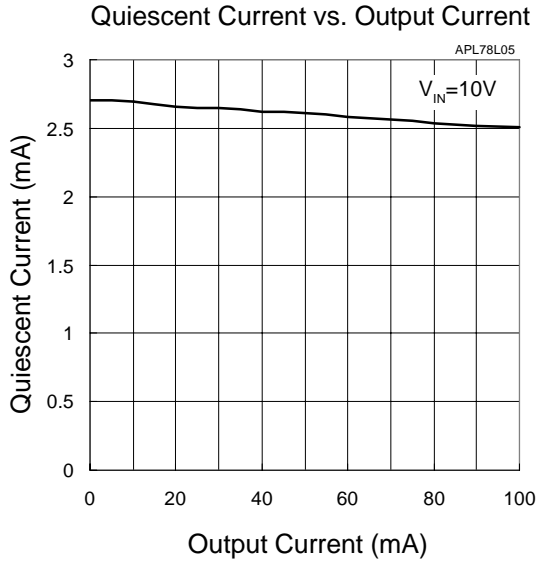

Typical Characteristics (Cont.)

Line Transient Response

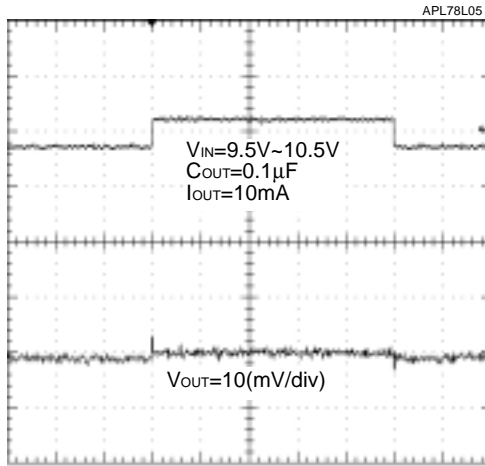

Time (100us/div)

Maximum Power Dissipation vs. Ambient Temperature

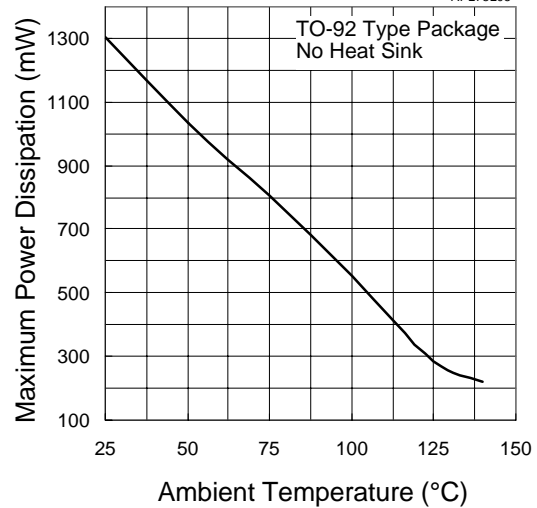

Output Voltage vs. Ambient Temperature

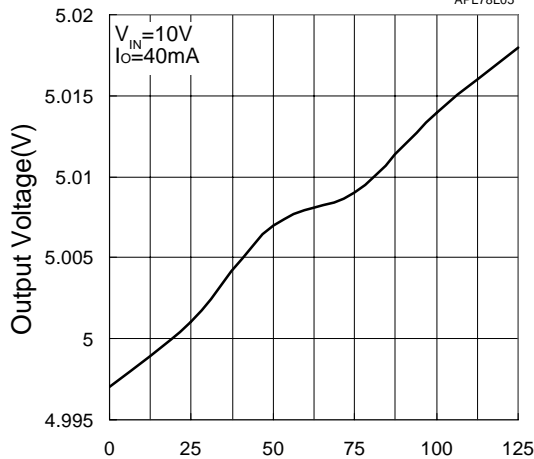

Ambient Temperature (°C)

Region of Stable ESR vs. Output Current

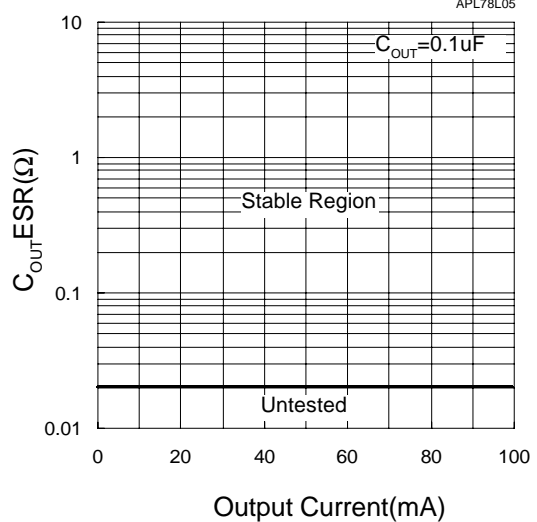

Typical Characteristics

The APL78L05/12 Series of fixed voltage regulators are designed with Thermal Overload Protection that shuts down the circuit when subjected to an excessive power overload condition. Internal Short Circuit Protection limits the maximum current the circuit will pass.

In many low current applications, compensation capacitors are not required. However, it is recommended that the regulator input be bypassed with a capacitor if the regulator is connected to the power supply filter with long wire lengths, or if the output load capacitance is large. The input bypass capacitor should be selected to provide good high-frequency characteristics to insure stable operation under all load conditions. A 0.33μF or larger tantalum, mylar, or other capacitor having low internal impedance at high frequencies should be chosen. The bypass capacitor should be mounted with the shortest possible leads directly across the regulators input terminals. Good construction techniques should be used to minimize ground loops and lead resistance drops since the regulator has no external sense lead. Bypassing the output is also recommended.

Figure 1. Current Regulator

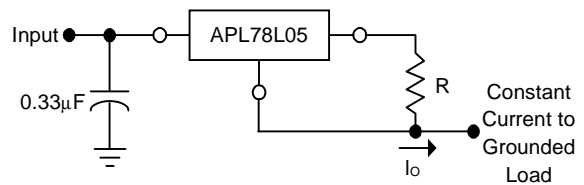

The APL78L00 regulators can also be used as a current source when connected as above. In order to minimize dissipation the APL78L05 is chosen in this application. Resistor R determines the current as follows :

$$I_o = \frac{5.0V}{R} + I_B$$

$$I_B = 3.8mA \text{ over line and load changes}$$

For example, a 100mA current source would require R to be a 50Ω, 1/2W resistor and the output voltage compliance would be the input voltage less 7V.

Figure 2. ±15V Tracking Voltage Regulator

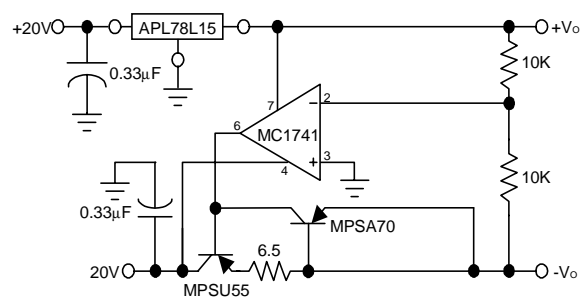
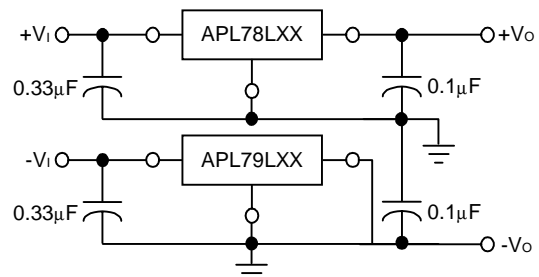
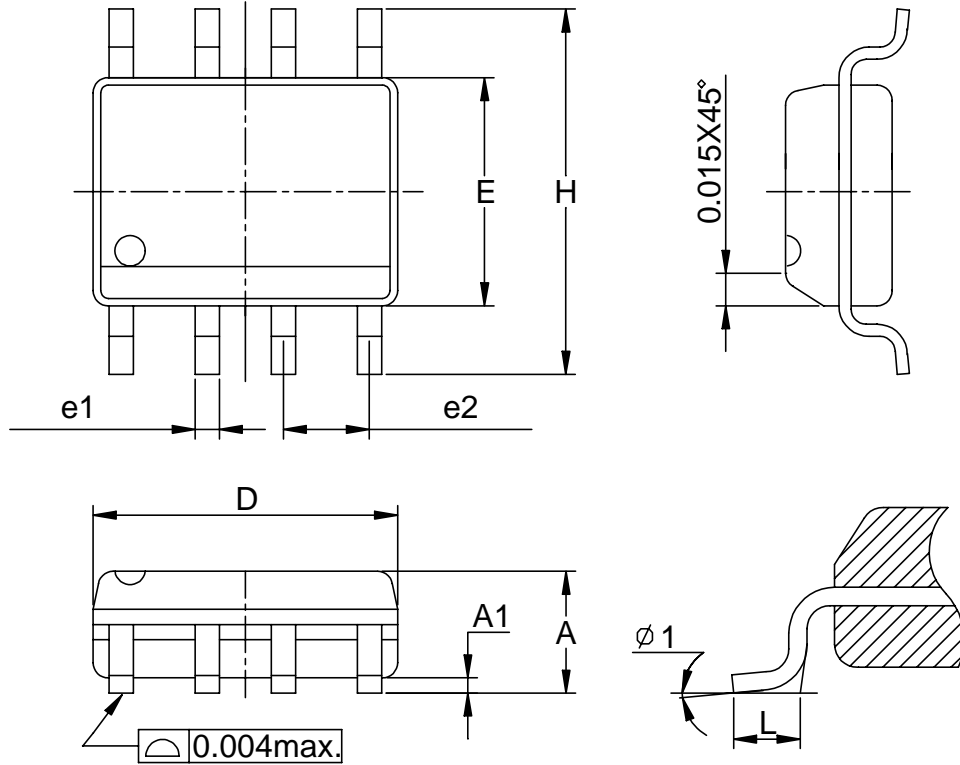

Figure 3. Positive and Negative Regulator



Packaging Information

SOP-8 pin (Reference JEDEC Registration MS-012)



Dim	Millimeters		Inches	
	Min.	Max.	Min.	Max.
A	1.35	1.75	0.053	0.069
A1	0.10	0.25	0.004	0.010
D	4.80	5.00	0.189	0.197
E	3.80	4.00	0.150	0.157
H	5.80	6.20	0.228	0.244
L	0.40	1.27	0.016	0.050
e1	0.33	0.51	0.013	0.020
e2	1.27BSC		0.50BSC	
φ 1	8°		8°	

Package Information

TO-92

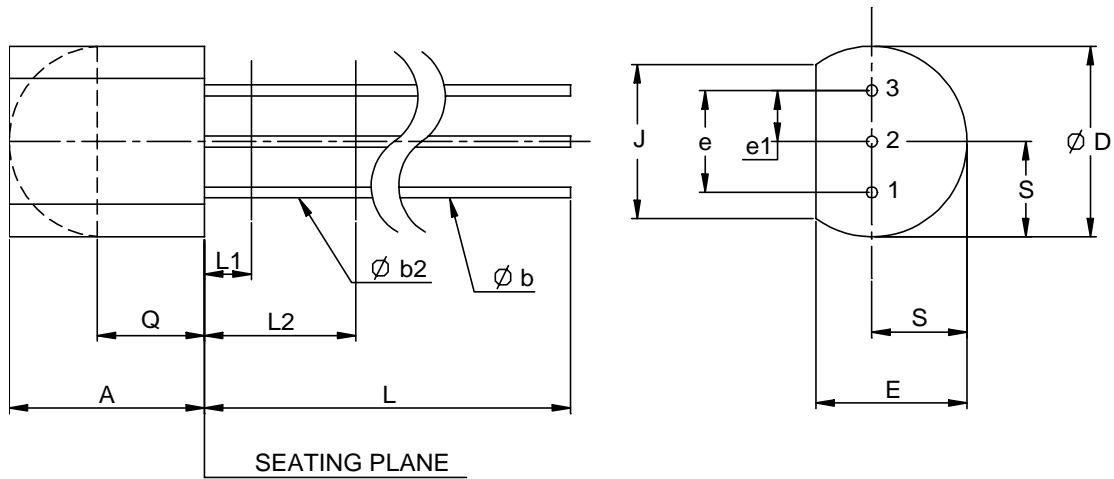

Dim	Millimeters		Inches	
	Min.	Max.	Min.	Max.
A	4.58	5.33	0.170	0.210
φ b	0.41	0.53	0.160	0.021
φ b2	0.41	0.48	0.160	0.019
φ D	4.96	5.20	0.175	0.205
E	3.94	4.19	0.125	0.165
e	2.42	2.66	0.095	0.105
e1	1.15	1.39	0.045	0.055
J	3.43		0.135	
L	12.70		0.500	
L1		1.27		0.050
L2	6.35		0.250	
Q	2.93		0.115	
S	2.42	2.66	0.080	0.105

Package Information

SOT-89 (Reference EIAJ ED-7500A Registration SC-62)

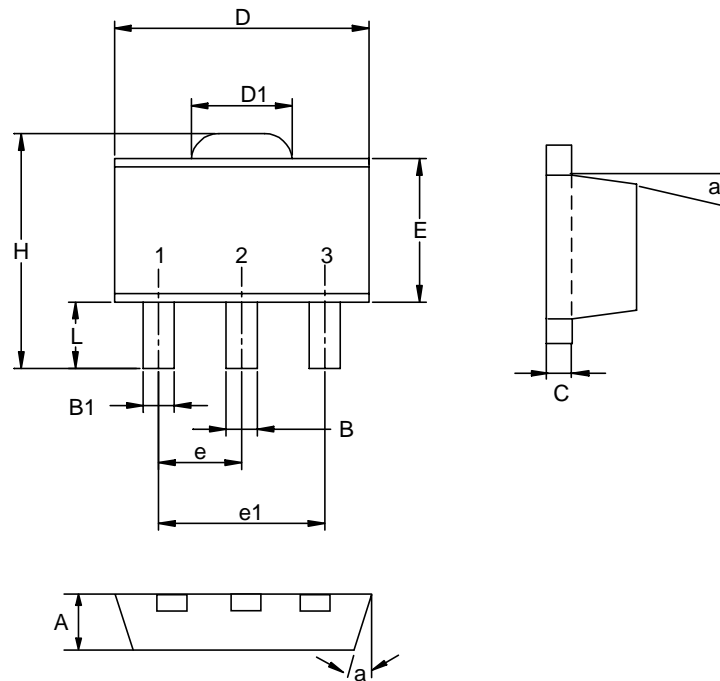

Dim	Millimeters		Inches	
	Min.	Max.	Min.	Max.
A	1.40	1.60	0.055	0.063
B	0.40	0.56	0.016	0.022
B1	0.35	0.48	0.014	0.019
C	0.35	0.44	0.014	0.017
D	4.40	4.60	0.173	0.181
D1	1.35	1.83	0.053	0.072
e	1.50 BSC		0.059 BSC	
e1	3.00 BSC		0.118 BSC	
E	2.29	2.60	0.090	0.102
H	3.75	4.25	0.148	0.167
L	0.80	1.20	0.031	0.047
α		10°		10°

Physical Specifications

Terminal Material	Solder-Plated Copper (Solder Material : 90/10 or 63/37 SnPb).
Lead Solderability	Meets EIA Specification RSI86-91, ANSI/J-STD-002 Category 3.

Reflow Condition (IR/Convection or VPR Reflow)

Reference JEDEC Standard J-STD-020A APRIL 1999

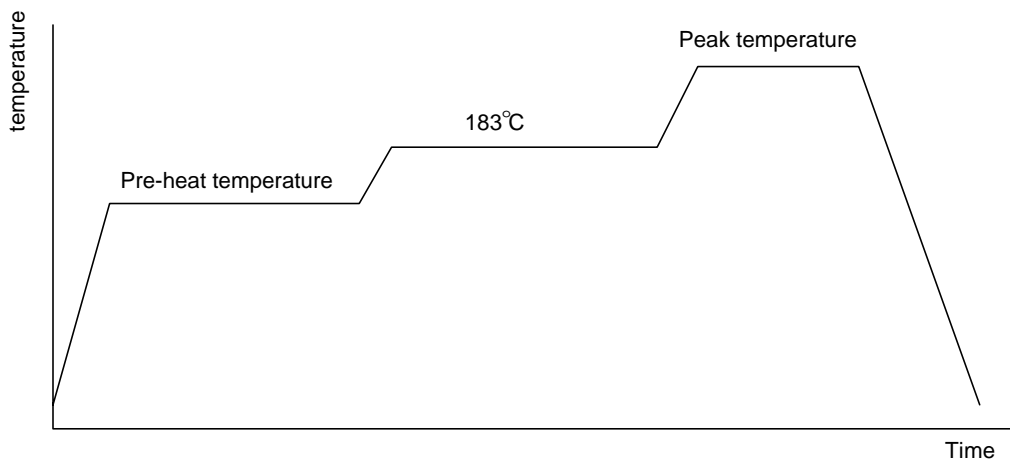

Classification Reflow Profiles

	Convection or IR/ Convection	VPR
Average ramp-up rate(183°C to Peak)	3°C/second max.	10 °C /second max.
Preheat temperature 125 ± 25°C)	120 seconds max.	
Temperature maintained above 183°C	60 ~ 150 seconds	
Time within 5°C of actual peak temperature	10 ~ 20 seconds	60 seconds
Peak temperature range	220 +5/-0°C or 235 +5/-0°C	215~ 219°C or 235 +5/-0°C
Ramp-down rate	6 °C /second max.	10 °C /second max.
Time 25°C to peak temperature	6 minutes max.	

Package Reflow Conditions

pkg. thickness ≥ 2.5mm and all bags	pkg. thickness < 2.5mm and pkg. volume ≥ 350 mm ³	pkg. thickness < 2.5mm and pkg. volume < 350mm ³
Convection 220 +5/-0 °C		Convection 235 +5/-0 °C
VPR 215-219 °C		VPR 235 +5/-0 °C
IR/Convection 220 +5/-0 °C		IR/Convection 235 +5/-0 °C

Reliability test program

Test item	Method	Description
SOLDERABILITY	MIL-STD-883D-2003	245°C , 5 SEC
HOLT	MIL-STD-883D-1005.7	1000 Hrs Bias @ 125 °C
PCT	JESD-22-B, A102	168 Hrs, 100 % RH , 121°C
TST	MIL-STD-883D-1011.9	-65°C ~ 150°C, 200 Cycles
ESD	MIL-STD-883D-3015.7	VHBM > 2KV, VMM > 200V
Latch-Up	JESD 78	10ms , I _{tr} > 100mA

Carrier Tape & Reel Dimensions

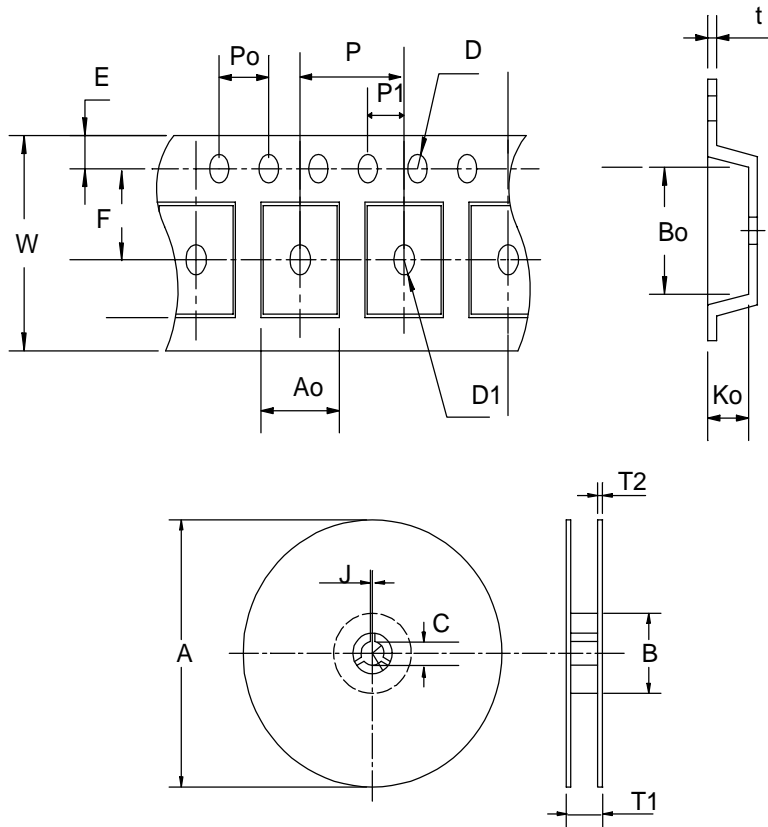

Application	A	B	C	J	T1	T2	W	P	E
SOP-8	330±1	62 ± 1.5	12.75 + 0.15	2 + 0.5	12.4 +0.2	2± 0.2	12 + 0.3 - 0.1	8± 0.1	1.75± 0.1
	F	D	D1	Po	P1	Ao	Bo	Ko	t
	5.5 ± 0.1	1.55±0.1	1.55+ 0.25	4.0 ± 0.1	2.0 ± 0.1	6.4 ± 0.1	5.2± 0.1	2.1± 0.1	0.3±0.013

(mm)

Carrier Tape & Reel Dimensions

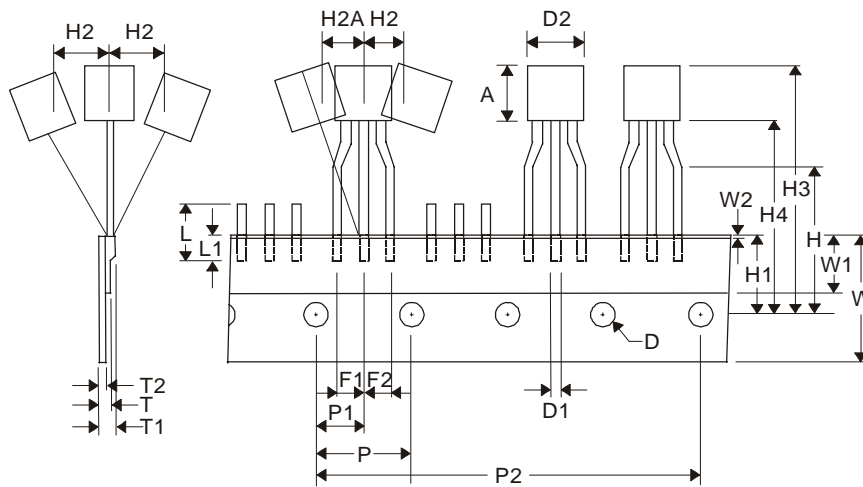

Application	A	D	D1	D2	F1,F2	H	H1	H2	H2A
TO-92	3.18~12	4.0±0.2	0.36~0.53	9.0 MAX	2.5+0.2 -0.1	16±0.5	9±0.5	0.5 MAX	0.5 MAX
	H3	H4	L	L1	P	P1	P2	T	T1
	27.0 MAX	20.0 MAX	11.0 MAX	2.5 MIN	12.7±0.2	6.35±0.4	50.8±0.5	0.55 MAX	1.42 MAX
	T2	W	W1	W2					
	0.36~0.68	17.5~19	5.0~7.0	0.5 MAX					

(mm)

Cover Tape Dimensions

Application	Carrier Width	Cover Tape Width	Devices Per Reel
SOP- 8	12	9.3	2500
TO-92	17.5~19	5.0~7.0	2000

Customer Service

Anpec Electronics Corp.

Head Office :

5F, No. 2 Li-Hsin Road, SBIP,

Hsin-Chu, Taiwan, R.O.C.

Tel : 886-3-5642000

Fax : 886-3-5642050

Taipei Branch :

7F, No. 137, Lane 235, Pac Chiao Rd.,

Hsin Tien City, Taipei Hsien, Taiwan, R. O. C.

Tel : 886-2-89191368

Fax : 886-2-89191369