

## P-Channel Enhancement Mode MOSFET

### Features

- 20V/-7A,  $R_{DS(ON)} = 25m\Omega(\text{typ.}) @ V_{GS} = -10V$   
 $R_{DS(ON)} = 35m\Omega(\text{typ.}) @ V_{GS} = -4.5V$   
 $R_{DS(ON)} = 55m\Omega(\text{typ.}) @ V_{GS} = -2.5V$
- Super High Density Cell Design
- Reliable and Rugged
- SOP-8 Package

### Pin Description

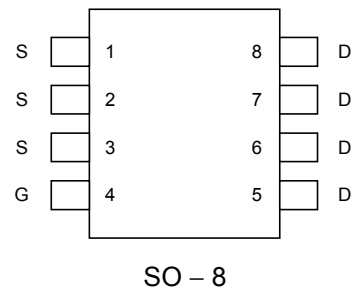

### Applications

- Power Management in Notebook Computer, Portable Equipment and Battery Powered Systems

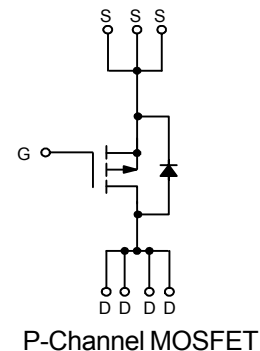

### Ordering and Marking Information

<p>APM4461 □□-□□</p> <p>□□ - Handling Code          □□ - Temp. Range          □□ - Package Code</p>	<p>Package Code          K : SO-8          Operation Junction Temp. Range          C : -55 to 150°C          Handling Code          TR : Tape &amp; Reel</p>
<p>APM4461 K : <span style="border: 1px solid black; padding: 2px;">APM4461 XXXXX</span></p>	<p>XXXXX - Date Code</p>

### Absolute Maximum Ratings ( $T_A = 25^\circ\text{C}$ unless otherwise noted)

Symbol	Parameter	Rating	Unit
$V_{DSS}$	Drain-Source Voltage	-20	V
$V_{GSS}$	Gate-Source Voltage	$\pm 20$	
$I_D^*$	Maximum Drain Current – Continuous	-7	A

\* Surface Mounted on FR4 Board,  $t \leq 10$  sec.

ANPEC reserves the right to make changes to improve reliability or manufacturability without notice, and advise customers to obtain the latest version of relevant information to verify before placing orders.

## Absolute Maximum Ratings (Cont.) (T<sub>A</sub> = 25°C unless otherwise noted)

Symbol	Parameter	Rating	Unit
I <sub>DM</sub>	Maximum Drain Current – Pulsed	-25	A
P <sub>D</sub>	Maximum Power Dissipation	T <sub>A</sub> =25 °C	2.5
		T <sub>A</sub> =100 °C	1.0
T <sub>J</sub>	Maximum Junction Temperature	150	°C
T <sub>STG</sub>	Storage Temperature Range	-55 to 150	°C
R <sub>θJA</sub>	Thermal Resistance – Junction to Ambient	50	°C/W

## Electrical Characteristics (T<sub>A</sub> = 25°C unless otherwise noted)

Symbol	Parameter	Test Condition	APM4461			Unit
			Min.	Typ.	Max.	
<b>Static</b>						
BV <sub>DSS</sub>	Drain-Source Breakdown Voltage	V <sub>GS</sub> =0V, I <sub>DS</sub> =-250A	-20			V
I <sub>DSS</sub>	Zero Gate Voltage Drain Current	V <sub>DS</sub> =-24V, V <sub>GS</sub> =0V			-1	μA
V <sub>GS(th)</sub>	Gate Threshold Voltage	V <sub>DS</sub> =V <sub>GS</sub> , I <sub>DS</sub> =-250μA	-0.6		-1.5	V
I <sub>GSS</sub>	Gate Leakage Current	V <sub>GS</sub> =±20V, V <sub>DS</sub> =0V			±100	nA
R <sub>DS(ON)</sub> <sup>a</sup>	Drain-Source On-state Resistance	V <sub>GS</sub> =-10V, I <sub>DS</sub> =-7A		25	35	mΩ
		V <sub>GS</sub> =-4.5V, I <sub>DS</sub> =-4A		35	50	
		V <sub>GS</sub> =-2.5V, I <sub>DS</sub> =-2A		55	65	
V <sub>SD</sub> <sup>a</sup>	Diode Forward Voltage	I <sub>SD</sub> =-2A, V <sub>GS</sub> =0V	-0.7		-1.3	V
<b>Dynamic<sup>b</sup></b>						
Q <sub>g</sub>	Total Gate Charge	V <sub>DS</sub> =-10V, V <sub>GS</sub> =-4.5V, I <sub>DS</sub> =-2A		17.8	21	nC
Q <sub>gs</sub>	Gate-Source Charge			4		
Q <sub>gd</sub>	Gate-Drain Charge			5.2		
t <sub>d(ON)</sub>	Turn-on Delay Time	V <sub>DD</sub> =-10V, I <sub>DS</sub> =-2A, V <sub>GEN</sub> =-4.5V, R <sub>G</sub> =0.2Ω		10	15	ns
T <sub>r</sub>	Turn-on Rise Time			15	20	
t <sub>d(OFF)</sub>	Turn-off Delay Time			32	26	
T <sub>f</sub>	Turn-off Fall Time			15	25	
C <sub>iss</sub>	Input Capacitance	V <sub>GS</sub> =0V		1240		pF
C <sub>oss</sub>	Output Capacitance	V <sub>DS</sub> =-15V		340		
C <sub>rss</sub>	Reverse Transfer Capacitance	Frequency=1.0MHz		216		

### Notes

<sup>a</sup> : Guaranteed by design, not subject to production testing

<sup>b</sup> : Pulse test ; pulse width ≤ 500μs, duty cycle ≤ 2%

## Typical Characteristics

Output Characteristics

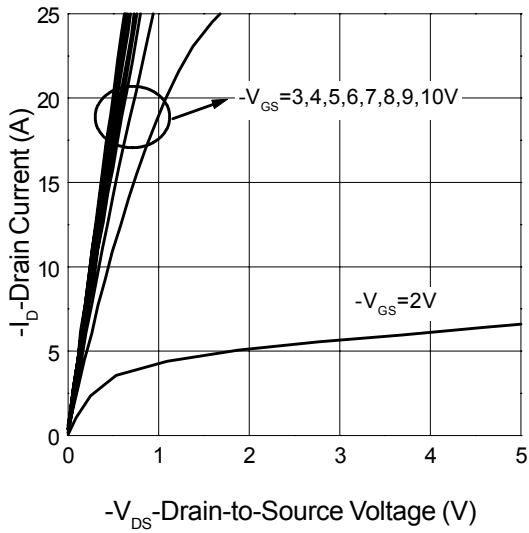

Transfer Characteristics

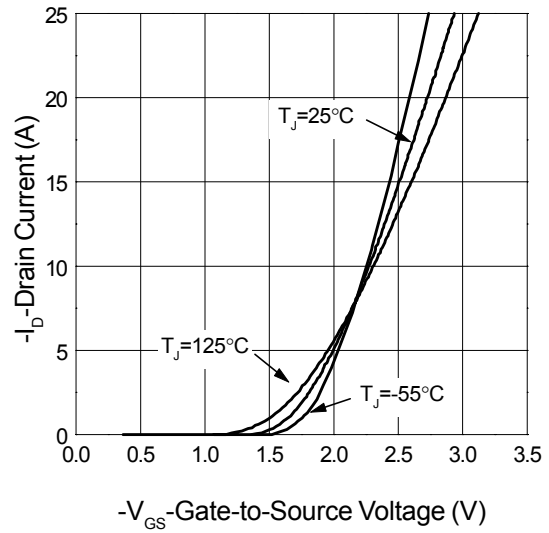

Threshold Voltage vs. Junction Temperature

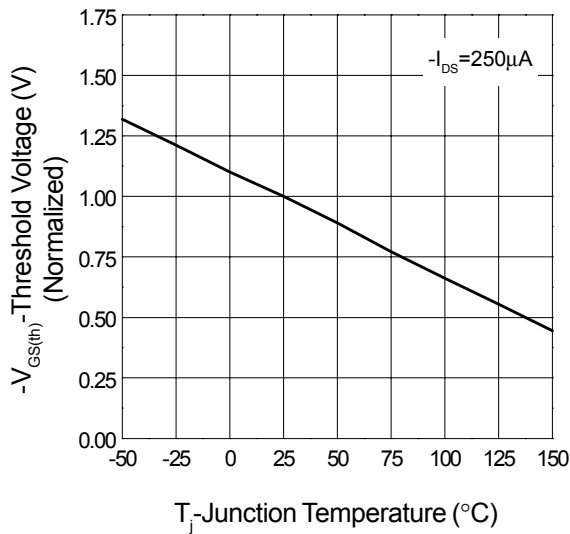

On-Resistance vs. Drain Current

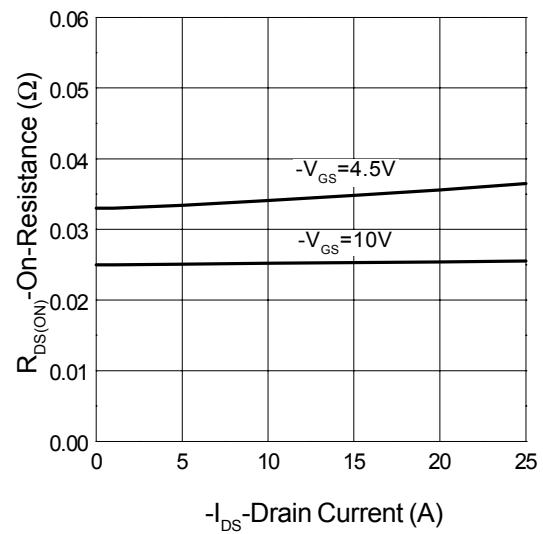

Typical Characteristics (Cont.)

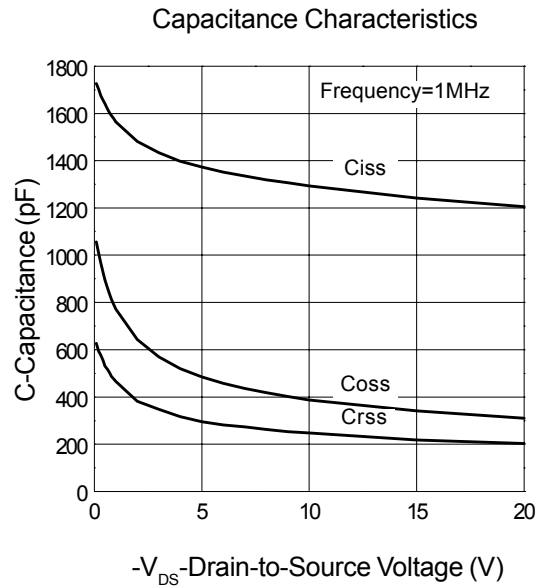
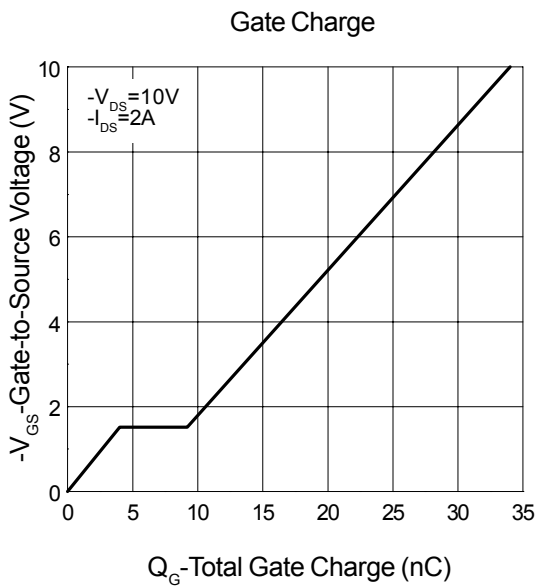
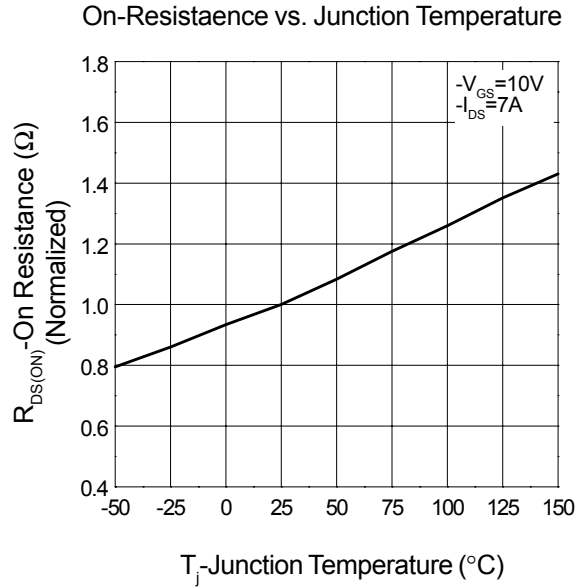
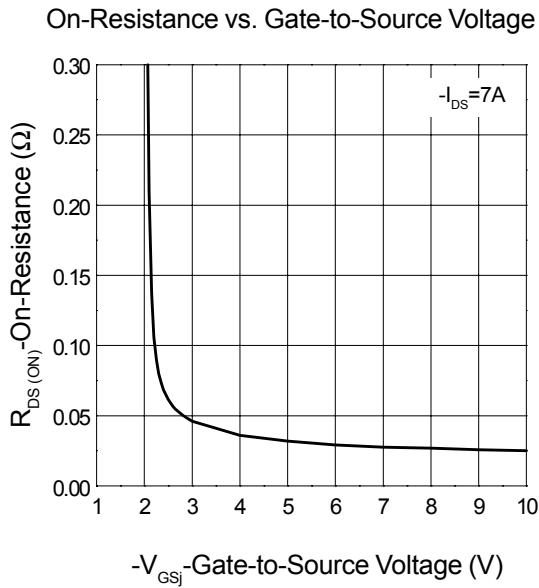

Typical Characteristics (Cont.)

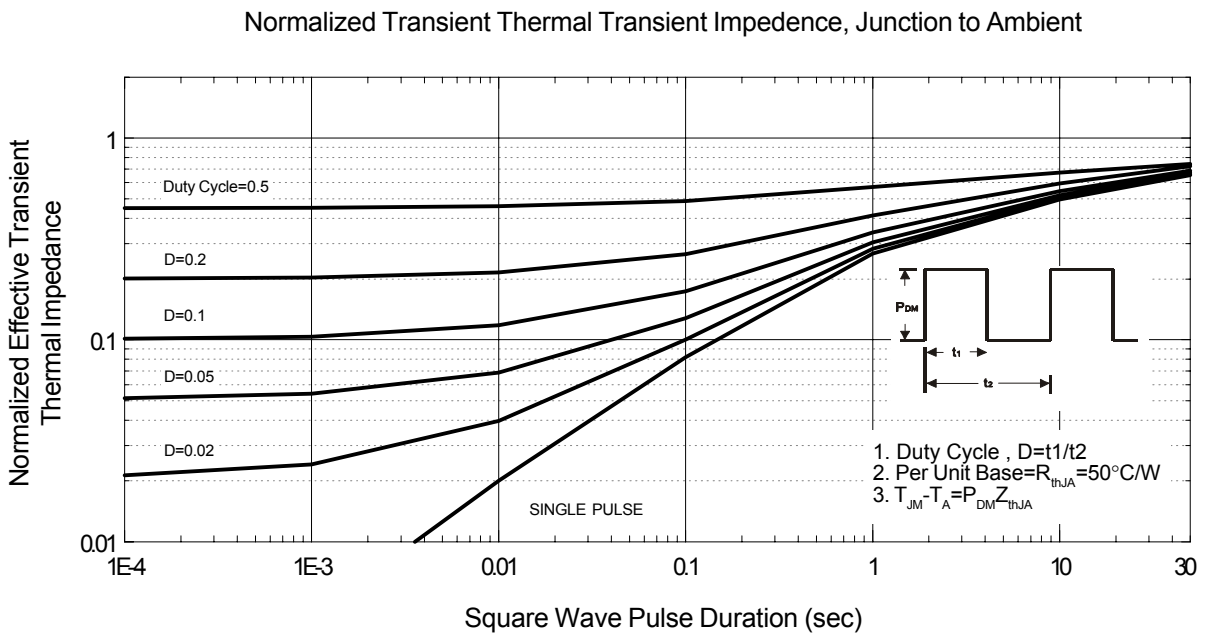
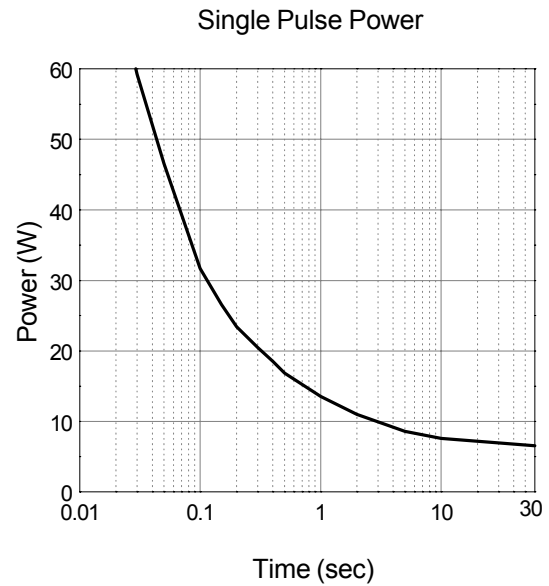
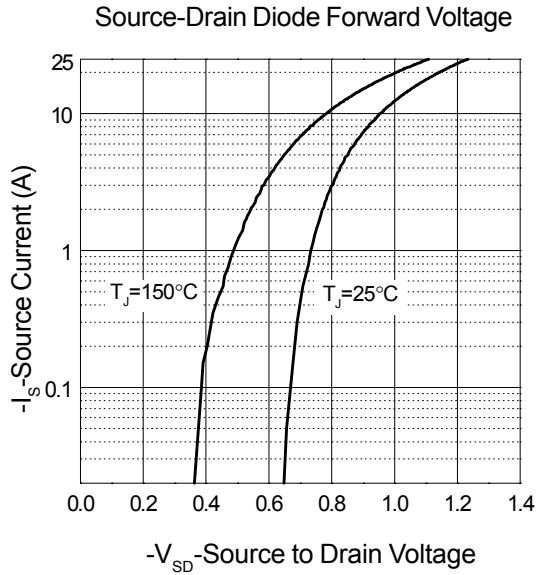

**Packaging Information**

SOP-8 pin ( Reference JEDEC Registration MS-012)

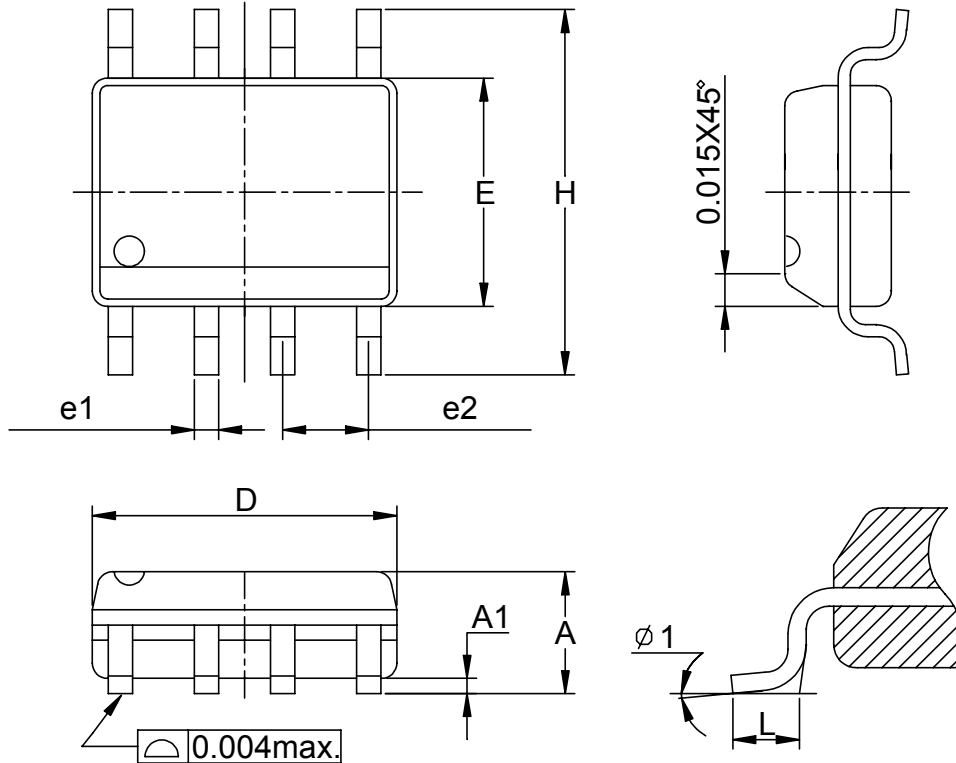

Dim	Millimeters		Inches	
	Min.	Max.	Min.	Max.
A	1.35	1.75	0.053	0.069
A1	0.10	0.25	0.004	0.010
D	4.80	5.00	0.189	0.197
E	3.80	4.00	0.150	0.157
H	5.80	6.20	0.228	0.244
L	0.40	1.27	0.016	0.050
e1	0.33	0.51	0.013	0.020
e2	1.27BSC		0.50BSC	
$\phi 1$	8°		8°	

## Physical Specifications

Terminal Material	Solder-Plated Copper (Solder Material : 90/10 or 63/37 SnPb)
Lead Solderability	Meets EIA Specification RSI86-91, ANSI/J-STD-002 Category 3.

## Reflow Condition (IR/Convection or VPR Reflow)

Reference JEDEC Standard J-STD-020A APRIL 1999

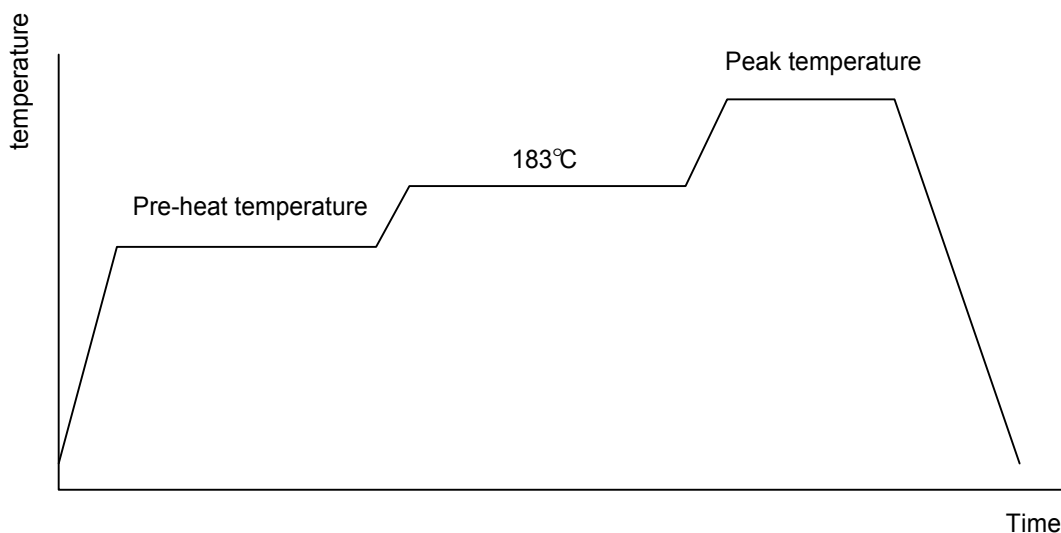

## Classification Reflow Profiles

	Convection or IR/ Convection	VPR
Average ramp-up rate(183°C to Peak)	3°C/second max.	10 °C /second max.
Preheat temperature 125 ± 25°C)	120 seconds max	
Temperature maintained above 183°C	60 – 150 seconds	
Time within 5°C of actual peak temperature	10 –20 seconds	60 seconds
Peak temperature range	220 +5/-0°C or 235 +5/-0°C	215-219°C or 235 +5/-0°C
Ramp-down rate	6 °C /second max.	10 °C /second max.
Time 25°C to peak temperature	6 minutes max.	

## Package Reflow Conditions

pkg. thickness ≥ 2.5mm and all bgas	pkg. thickness < 2.5mm and pkg. volume ≥ 350 mm <sup>3</sup>	pkg. thickness < 2.5mm and pkg. volume < 350mm <sup>3</sup>
Convection 220 +5/-0 °C		Convection 235 +5/-0 °C
VPR 215-219 °C		VPR 235 +5/-0 °C
IR/Convection 220 +5/-0 °C		IR/Convection 235 +5/-0 °C

## Reliability test program

Test item	Method	Description
SOLDERABILITY	MIL-STD-883D-2003	245°C, 5 SEC
HOLT	MIL-STD 883D-1005.7	1000 Hrs Bias @ 125°C
PCT	JESD-22-B, A102	168 Hrs, 100% RH, 121°C
TST	MIL-STD 883D-1011.9	-65°C ~ 150°C, 200 Cycles

## Carrier Tape

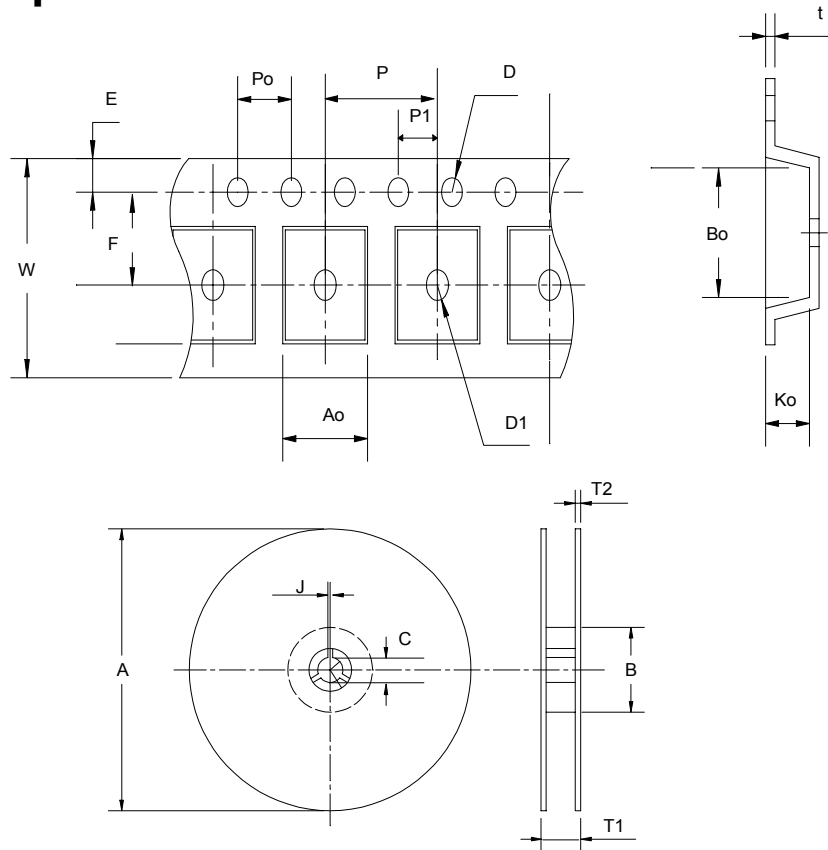

Application	A	B	C	J	T1	T2	W	P	E
SOP- 8	330 ± 1	62 +1.5	12.75+ 0.15	2 ± 0.5	12.4 ± 0.2	2 ± 0.2	12± 0.3	8± 0.1	1.75±0.1
	F	D	D1	Po	P1	Ao	Bo	Ko	t
	5.5± 1	1.55 +0.1	1.55+ 0.25	4.0 ± 0.1	2.0 ± 0.1	6.4 ± 0.1	5.2± 0.1	2.1± 0.1	0.3±0.013



## Cover Tape Dimensions

Application	Carrier Width	Cover Tape Width	Devices Per Reel
SOP- 8	12	9.3	2500

## Customer Service

**Anpec Electronics Corp.**

Head Office :

5F, No. 2 Li-Hsin Road, SBIP,  
Hsin-Chu, Taiwan, R.O.C.  
Tel : 886-3-5642000  
Fax : 886-3-5642050

Taipei Branch :

7F, No. 137, Lane 235, Pac Chiao Rd.,  
Hsin Tien City, Taipei Hsien, Taiwan, R. O. C.  
Tel : 886-2-89191368  
Fax : 886-2-89191369