

P-Channel Enhancement Mode MOSFET

Features

- -30V/-8A, $R_{DS(ON)} = 16m\Omega(\text{typ.}) @ V_{GS} = -10V$
 $R_{DS(ON)} = 24m\Omega(\text{typ.}) @ V_{GS} = -4.5V$
- Super High Density Cell Design
- Reliable and Rugged
- SO-8 Package

Pin Description

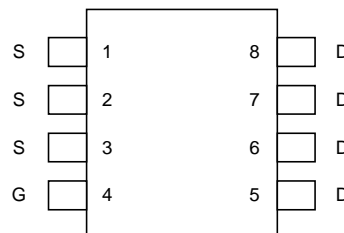

Applications

- Power Management in Notebook Computer, Portable Equipment and Battery Powered Systems

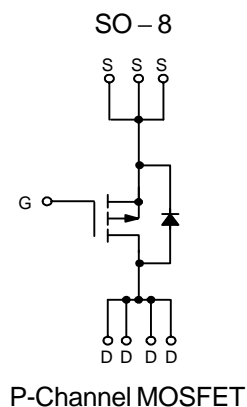

Ordering and Marking Information

<p>APM4835 □□-□□</p> <p>└───┬───┬───</p> <p> ├─── Handling Code</p> <p> ├─── Temp. Range</p> <p> └─── Package Code</p>	<p>Package Code K : SO-8</p> <p>Operation Junction Temp. Range C : -55 to 150°C</p> <p>Handling Code TU : Tube TR : Tape & Reel</p>
<p>APM4835</p> <div style="border: 1px solid black; display: inline-block; padding: 2px;"> <p>APM4835 XXXXX</p> </div>	<p>XXXXXX - Date Code</p>

Absolute Maximum Ratings ($T_A = 25^\circ\text{C}$ unless otherwise noted)

Symbol	Parameter	Rating	Unit
V_{DSS}	Drain-Source Voltage	-30	V
V_{GSS}	Gate-Source Voltage	± 25	
I_D^*	Maximum Drain Current – Continuous	-8	A
I_{DM}	Maximum Drain Current – Pulsed	-50	

*Surface Mounted on FR4 Board, $t \leq 10$ sec.

ANPEC reserves the right to make changes to improve reliability or manufacturability without notice, and advise customers to obtain the latest version of relevant information to verify before placing orders.

Absolute Maximum Ratings (Cont.) ($T_A = 25^\circ\text{C}$ unless otherwise noted)

Symbol	Parameter	Rating	Unit
P_D	Maximum Power Dissipation	$T_A = 25^\circ\text{C}$	2.5
		$T_A = 100^\circ\text{C}$	1
T_J	Maximum Junction Temperature	150	$^\circ\text{C}$
T_{STG}	Storage Temperature Range	-55 to 150	
$R_{\theta JA}$	Thermal Resistance - Junction to Ambient	50	$^\circ\text{C}/\text{W}$

Electrical Characteristics ($T_A=25^\circ\text{C}$ unless otherwise noted)

Symbol	Parameter	Test Condition	APM4835			Unit
			Min.	Typ ^a .	Max.	
Static						
BV_{DSS}	Drain-Source Breakdown Voltage	$V_{GS}=0V, I_D = -250\mu\text{A}$	-30			V
I_{DSS}	Zero Gate Voltage Drain Current	$V_{DS} = -30V, V_{GS}=0V$			-1	μA
$V_{GS(th)}$	Gate Threshold Voltage	$V_{DS}=V_{GS}, I_D = -250\mu\text{A}$	-1	-1.5	-2	V
I_{GSS}	Gate Leakage Current	$V_{GS} = \pm 25V, V_{DS}=0V$			± 100	nA
$R_{DS(ON)}$	Drain-Source On-state Resistance ^b	$V_{GS} = -10V, I_D = -8A$		16	19	m Ω
		$V_{GS} = -4.5V, I_D = -5A$		24	30	
V_{SD}	Diode Forward Voltage ^b	$I_{SD} = -3A, V_{GS}=0V$		-0.7	-1.3	V
Dynamic^a						
Q_g	Total Gate Charge	$V_{DS} = -15V, V_{GS} = -10V,$ $I_D = -4.6A$		48	60	nC
Q_{gs}	Gate-Source Charge			10		
Q_{gd}	Gate-Drain Charge			9		
$t_{d(ON)}$	Turn-on Delay Time	$V_{DD} = -25V, I_D = -2A,$ $V_{GEN} = -10V, R_G = 6\Omega$ $R_L = 12.5\Omega$		16	30	ns
t_r	Turn-on Rise Time			17	30	
$t_{d(OFF)}$	Turn-off Delay Time			75	120	
t_f	Turn-off Fall Time			31	80	
C_{iss}	Input Capacitance	$V_{GS}=0V, V_{DS}=-25V$ Frequency = 1.0MHZ		3800		pF
C_{oss}	Output Capacitance			590		
C_{riss}	Reverse Transfer Capacitance			250		

Notes
^a : Guaranteed by design, not subject to production testing

^b : Pulse test ; pulse width $\leq 500\mu\text{s}$, duty cycle $\leq 2\%$

Typical Characteristics

Output Characteristics

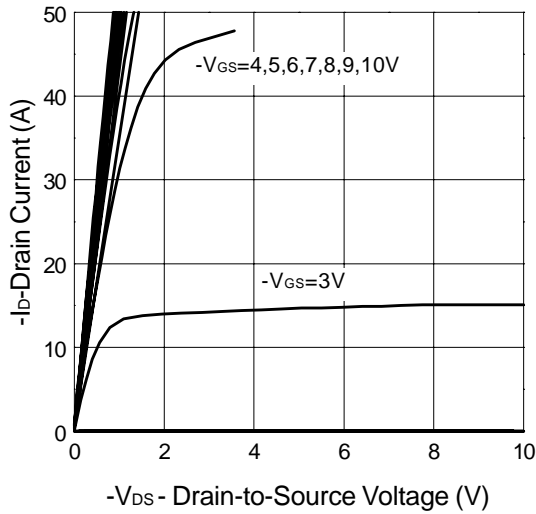

Transfer Characteristics

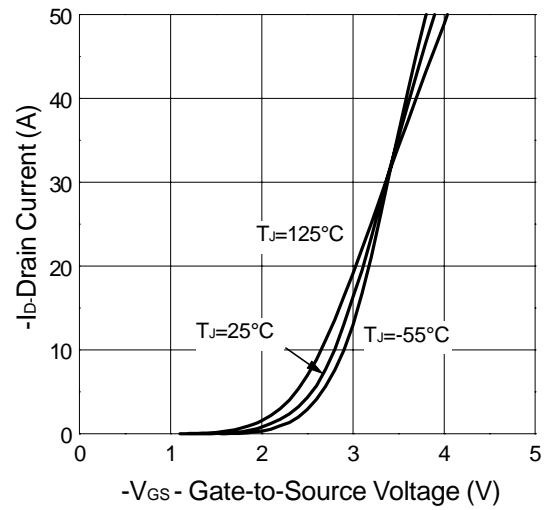

Threshold Voltage vs. Junction Temperature

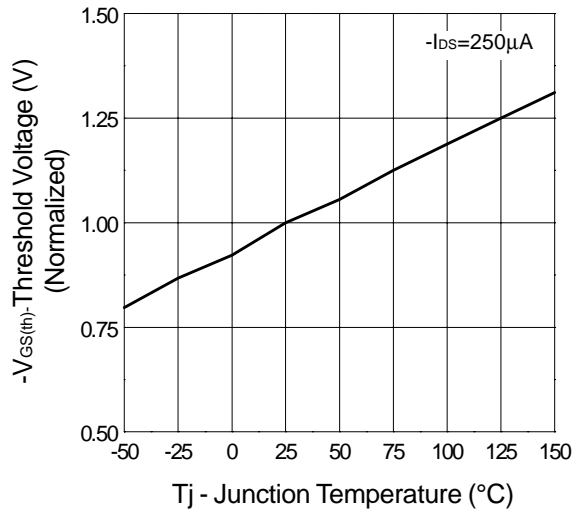

On-Resistance vs. Drain Current

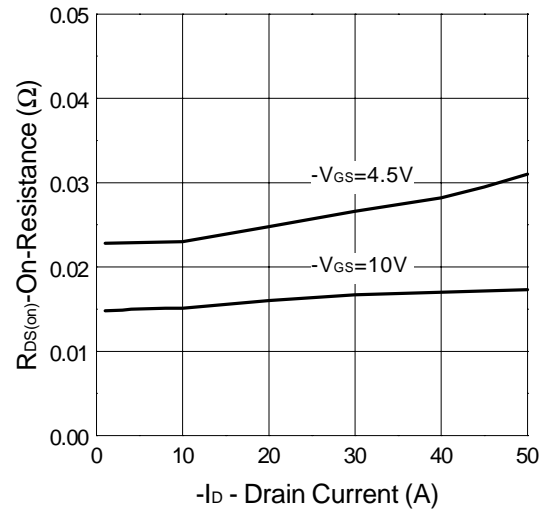

Typical Characteristics (Cont.)

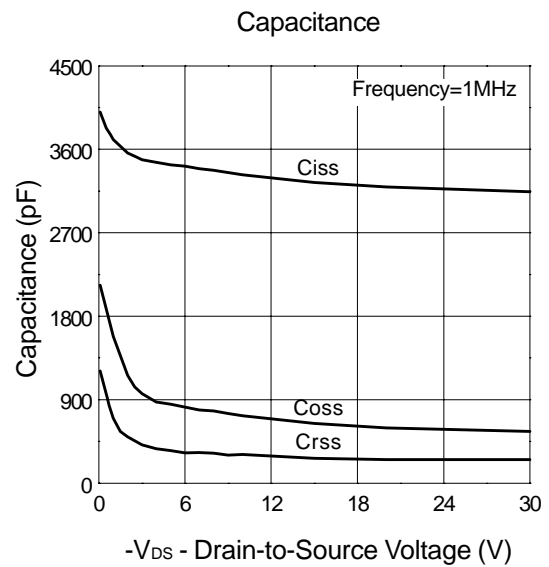
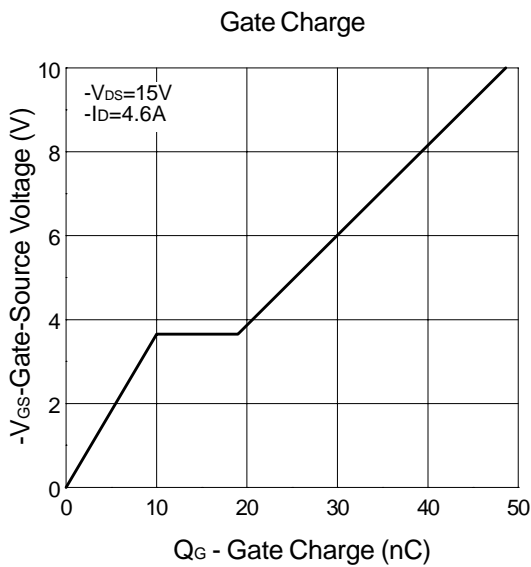
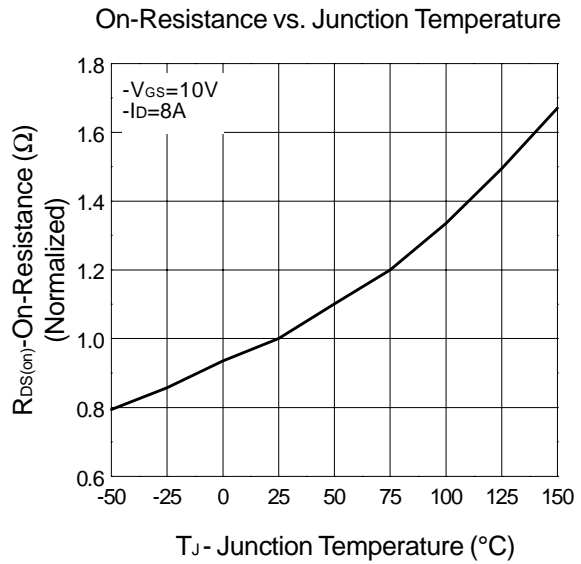
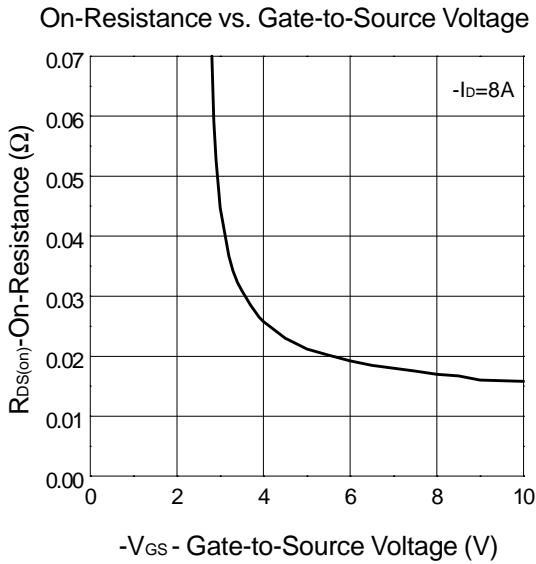

Typical Characteristics (Cont.)

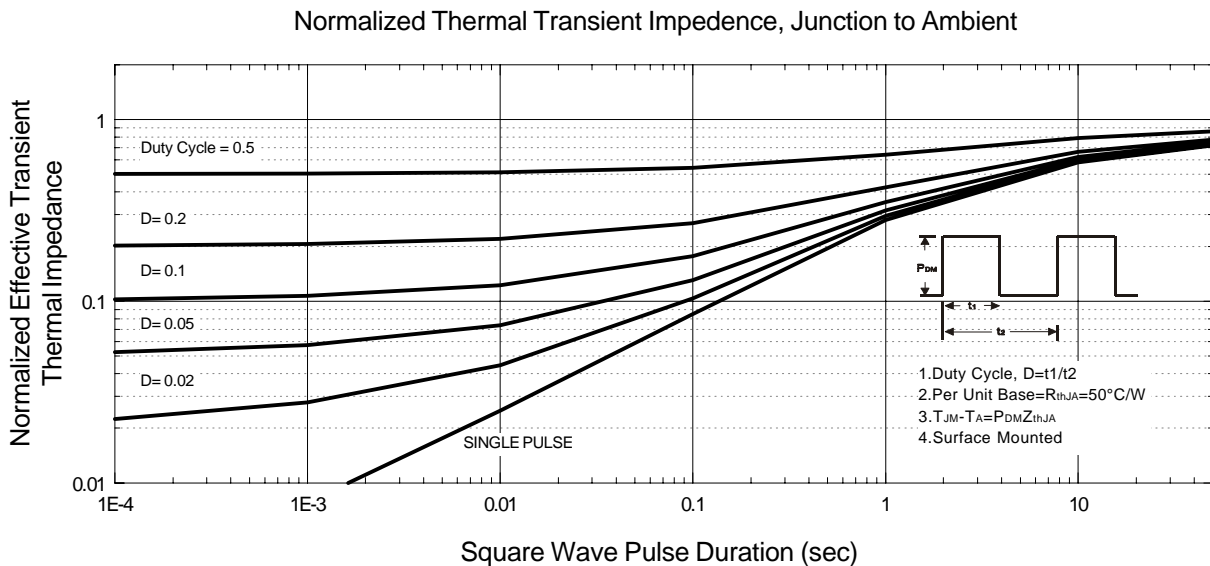
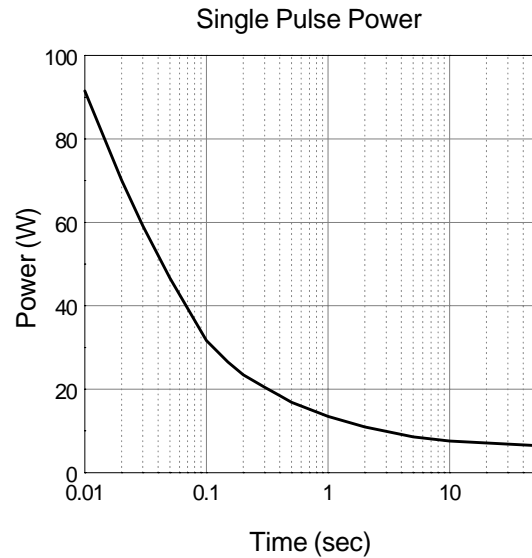
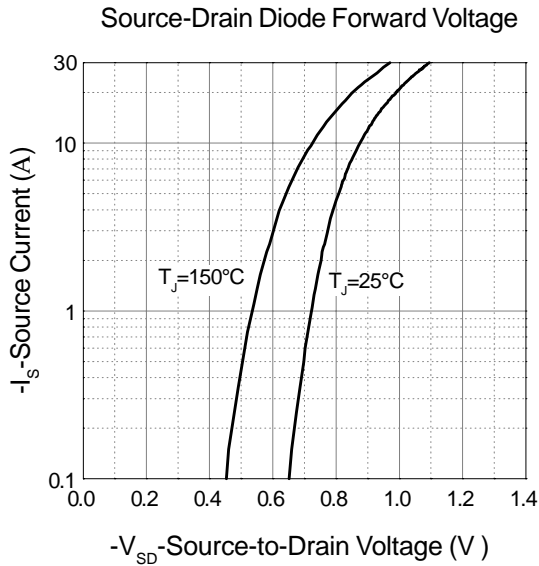

Packaging Information

SOP-8 pin (Reference JEDEC Registration MS-012)

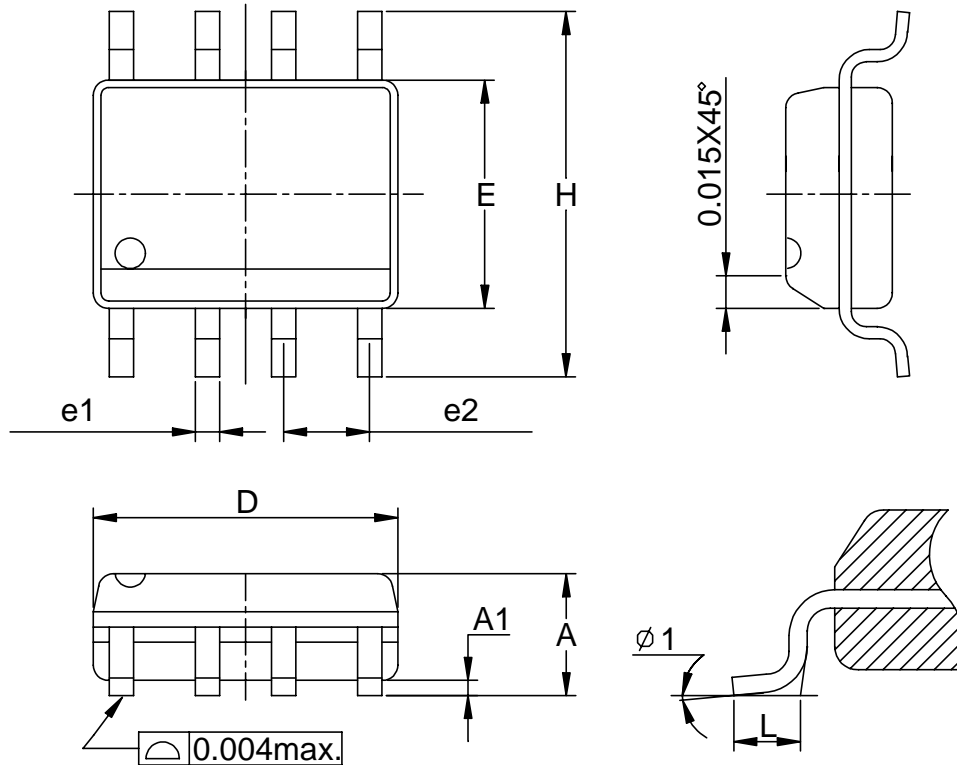

Dim	Millimeters		Inches	
	Min.	Max.	Min.	Max.
A	1.35	1.75	0.053	0.069
A1	0.10	0.25	0.004	0.010
D	4.80	5.00	0.189	0.197
E	3.80	4.00	0.150	0.157
H	5.80	6.20	0.228	0.244
L	0.40	1.27	0.016	0.050
e1	0.33	0.51	0.013	0.020
e2	1.27BSC		0.50BSC	
φ 1	8°		8°	

Physical Specifications

Terminal Material	Solder-Plated Copper (Solder Material : 90/10 or 63/37 SnPb)
Lead Solderability	Meets EIA Specification RSI86-91, ANSI/J-STD-002 Category 3.

Reflow Condition (IR/Convection or VPR Reflow)

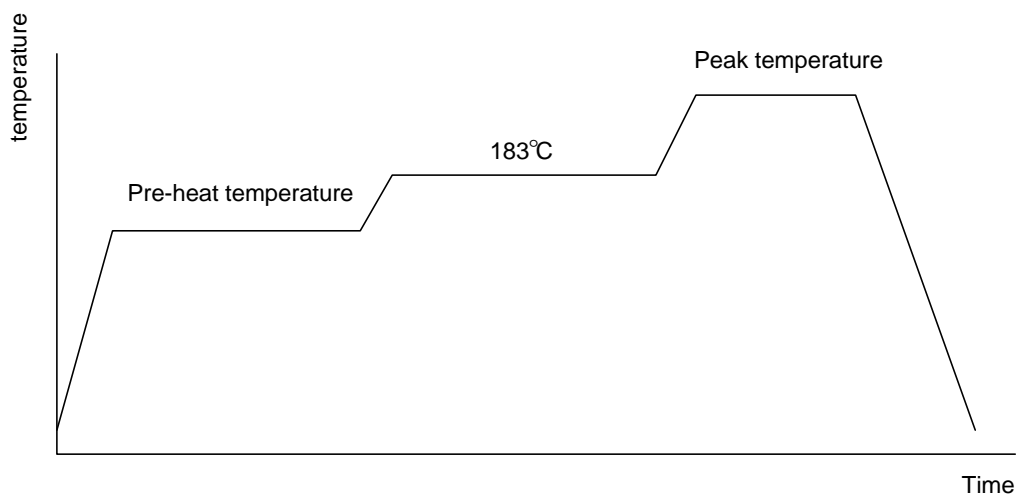

Classification Reflow Profiles

	Convection or IR/ Convection	VPR
Average ramp-up rate(183°C to Peak)	3°C/second max.	10 °C /second max.
Preheat temperature 125 ± 25°C)	120 seconds max	
Temperature maintained above 183°C	60 – 150 seconds	
Time within 5°C of actual peak temperature	10 –20 seconds	60 seconds
Peak temperature range	220 +5/-0°C or 235 +5/-0°C	215-219°C or 235 +5/-0°C
Ramp-down rate	6 °C /second max.	10 °C /second max.
Time 25°C to peak temperature	6 minutes max.	

Package Reflow Conditions

pkg. thickness ≥ 2.5mm and all bgas	pkg. thickness < 2.5mm and pkg. volume ≥ 350 mm ³	pkg. thickness < 2.5mm and pkg. volume < 350mm ³
Convection 220 +5/-0 °C		Convection 235 +5/-0 °C
VPR 215-219 °C		VPR 235 +5/-0 °C
IR/Convection 220 +5/-0 °C		IR/Convection 235 +5/-0 °C

Reliability test program

Test item	Method	Description
SOLDERABILITY	MIL-STD-883D-2003	245°C, 5 SEC
HOLT	MIL-STD 883D-1005.7	1000 Hrs Bias @ 125°C
PCT	JESD-22-B, A102	168 Hrs, 100% RH, 121°C
TST	MIL-STD 883D-1011.9	-65°C ~ 150°C, 200 Cycles

Carrier Tape & Reel Dimensions

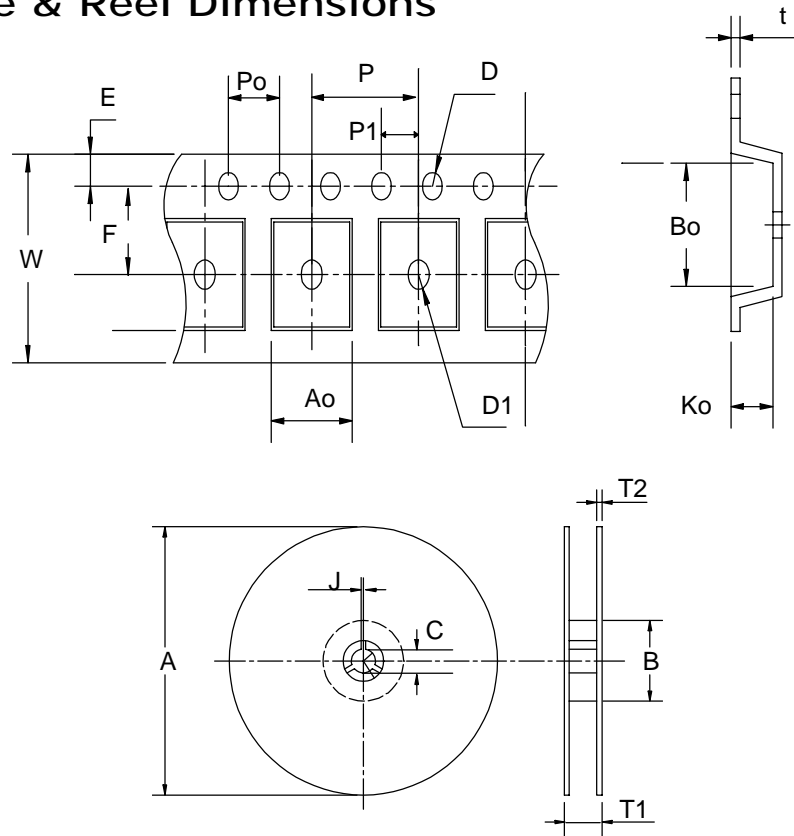

Application	A	B	C	J	T1	T2	W	P	E
SOP- 8	330 ± 1	62 +1.5	12.75+ 0.15	2 ± 0.5	12.4 ± 0.2	2 ± 0.2	12 ± 0.3	8 ± 0.1	1.75 ± 0.1
	F	D	D1	Po	P1	Ao	Bo	Ko	t
	5.5 ± 1	1.55 +0.1	1.55+ 0.25	4.0 ± 0.1	2.0 ± 0.1	6.4 ± 0.1	5.2 ± 0.1	2.1 ± 0.1	0.3 ± 0.013

Cover Tape Dimensions

Application	Carrier Width	Cover Tape Width	Devices Per Reel
SOP- 8	12	9.3	2500

Customer Service

Anpec Electronics Corp.

Head Office :

5F, No. 2 Li-Hsin Road, SBIP,

Hsin-Chu, Taiwan, R.O.C.

Tel : 886-3-5642000

Fax : 886-3-5642050

Taipei Branch :

7F, No. 137, Lane 235, Pac Chiao Rd.,

Hsin Tien City, Taipei Hsien, Taiwan, R. O. C.

Tel : 886-2-89191368

Fax : 886-2-89191369