

AP2101

Power-Housekeeping PWM Combo Controller

(Preliminary)

■ Features

- A complete PWM control and housekeeping circuitry
- Precision voltage reference trimmed to 2%
- Dual output for push-pull operation
- Each output Transistor for 200mA sink current
- Variable duty cycle by dead time control (DTC)
- Soft start capability
- Double pulse suppression logic
- Over voltage protection (OVP) for 3.3V/±5V/±12V
- Under voltage protection (UVP) for 3.3V/±5V/±12V
- One more external input for various protections (PT)
- Remote on/off control function (PS-ON)
- Latch function controlled by remote and protection input
- Power good signal generator (PG) with hysteresis

■ Ordering Information

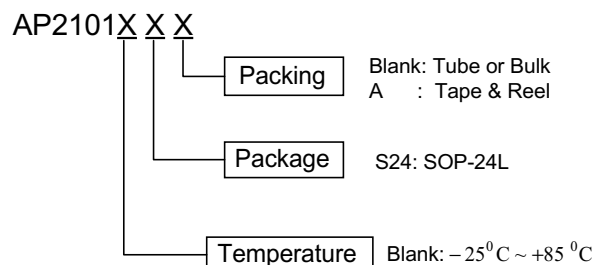

■ General Description

The AP2101 is a monolithic pulse-width modulation (PWM) control circuit with complete housekeeping circuitry for use in the secondary side of SMPS (Switching mode power supply). It contains various functions, which are precision voltage reference, over voltage protection (OVP), under voltage protection (UVP), remote on/off control, power good signal generator (PG) and etc. The AP2101 only requires few external components to accomplish a complete housekeeping circuit for SMPS, and is available in a 24-pin dual in-line package.

OVP

It has OVP functions for +3.3V, +5V, +12V, -5V, -12V and PT outputs. The circuit is made of a comparator with six detecting inputs and without hysteresis voltage. Especially, PT (Pin18) is prepared for and extra OVP input or another protection signal.

UVP

It also has UVP functions for +3.3V, +5V, +12V, -5V, -12V output. The block is made up of a comparator with five detecting inputs and without hysteresis voltage.

Remote on/off

Remote on/off section is used to control SMPS externally. If a high signal is supplied to the remote on/off input, PWM signal becomes a high state and all secondary outputs are grounded. The remote on/off signal is transferred with some on-delay and off-delay time of 8ms, 24ms respectively.

Precision voltage reference

The reference voltage trimmed to ±2% ($4.9V \leq V_{ref} \leq 5.1V$)

PG

PG is to monitor the voltage level of power supply for safe operation of a microprocessor.

AP2101

Power-Housekeeping PWM Combo Controller



(Preliminary)

■ Block Diagram

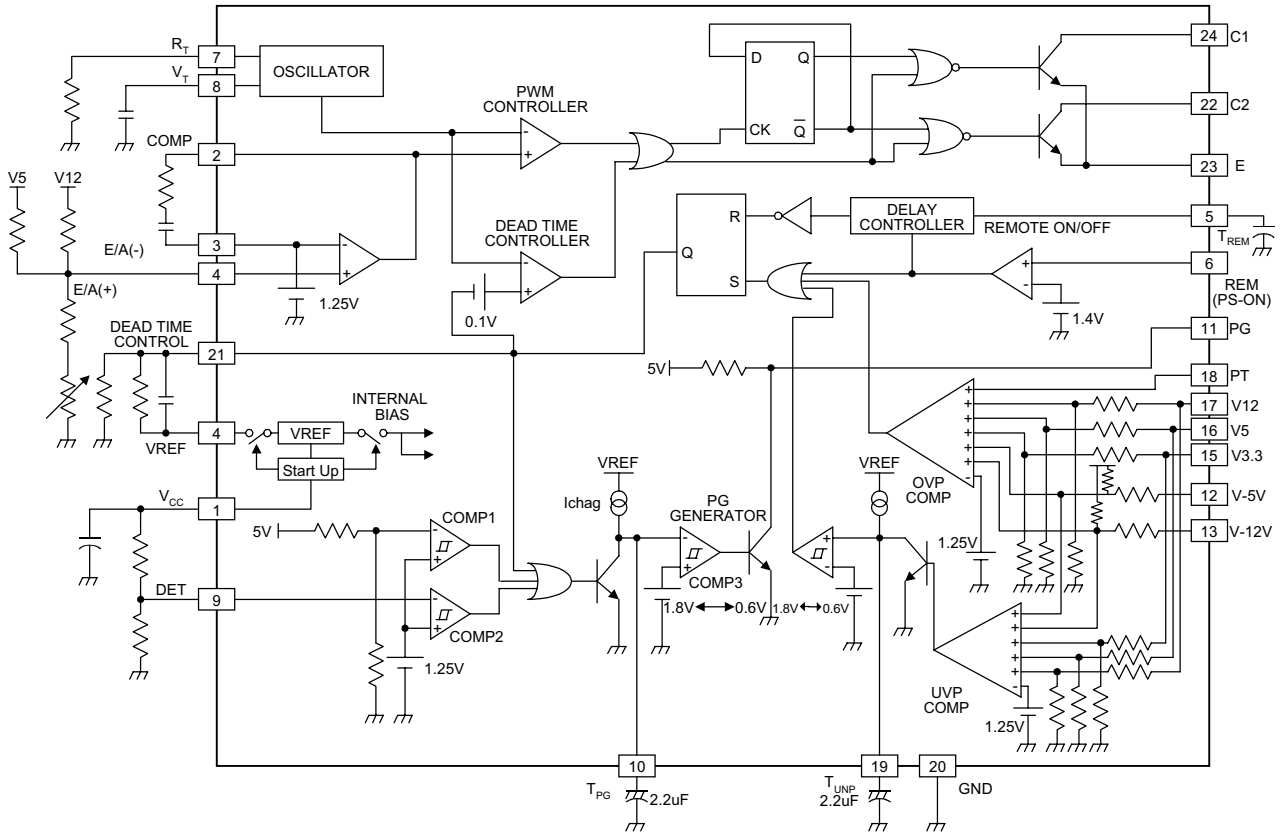

AP2101

Power-Housekeeping PWM Combo Controller



(Preliminary)

■ Pin Assignments

(Top View)

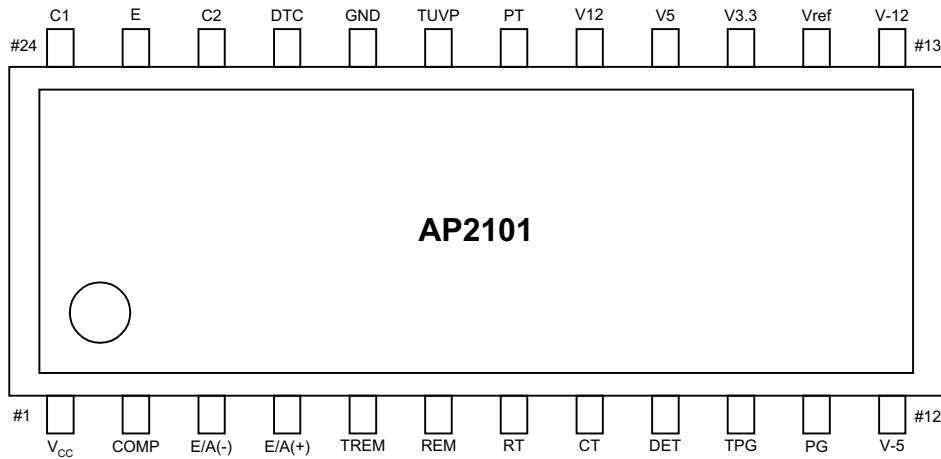

(SOP-24)

■ Pin Descriptions

Pin#	Name	I/O	Description	Pin#	Name	I/O	Description
1	V _{CC}	I	Supply voltage	13	V-12	I	OVP,UVP input for -12V
2	COMP	O	E/A output	14	Vref	O	Precision reference VTG
3	E/A(-)	I	E/A(-) input	15	V3.3	I	OVP,UVP input for 3.3V
4	E/A(+)	I	E/A(+) input	16	V5	I	OVP,UVP input for 5V
5	TREM	—	Remote on/off delay	17	V12	I	OVP,UVP input for 12V
6	REM	I	Remote on/off input	18	PT	I	Extra protection input
7	RT	—	Oscillation freq. Setting R	19	T _{UVP}	—	UVP delay
8	CT	—	Oscillation freq. Setting C	20	GND	—	Signal ground
9	DET	I	Detect input	21	DTC	I	Dead time control input
10	T _{PG}	—	Power good delay	22	C2	O	Output 2
11	PG	O	Power good signal output	23	E	—	Power ground
12	V-5	I	OVP,UVP input for -5V	24	C1	O	Output 1

■ Function Descriptions

Name	Function
VCC	Supply voltage. Operating rang is 14V~30V. VCC=20V, Ta=25°C at test
COMP	Error amplifier output. It is connect to non-inverting input of pulse width modulator comparator.
E/A(-)	Error amplifier inverting input. Its reference voltage is always 1.25V.
E/A(+)	Error amplifier non-inverting input feedback voltage. This pin may be used to sense power supply output voltage.
TREM	Remote on/off delay. Ton/Toff = 8ms/24ms (Typ.) with C=0.1μF. Its high/low threshold voltage is 1.7V/0.6V.
REM	Remote on/off input. It is TTL operation and its threshold voltage is 1.4V Voltage at this pin can reach normal 4.6V, with absolutely maximum voltage, 5.25V. If REM="Low", PWM="Low". That means the main SMPS is operational. When REM="High", then PWM="High" and the main SMPS is turned-off.
RT	Oscillation frequency setting R. (Test Condition R _T =10kΩ)
CT	Oscillation frequency setting C. (Test Condition C _T =0.01μF)
DET	Under-voltages detect pin. Its threshold voltage is 1.25V Typ.
T _{PG}	PG delay. Td=250ms (Typ) with C _{PG} =2.2μF. The high/low threshold voltage are 1.8V/0.6V and the voltage of Pin10 is clamped at 2.9V for noise margin.
PG	Power good output signal. PG="High" means that the power is "Good" for operation and PG="Low" means "Power fail".
V-5	Over voltage protection for output -5V (Typical Value = -6.2V)
V-12	Over voltage protection for output -12V (Typical Value = -14.2V)
Vref	Precision voltage reference trimmed to 2%. (Typical Value = 5.03V)
V3.3	Over voltage protection for output 3.3V. (Typical Value = 4.1V)
V5	Over voltage protection for output 5V. (Typical Value = 6.2V)
V12	Over voltage protection for output 12V. (Typical Value = 14.2V)
PT	This is prepared for an extra OVP input or another protection signal. (Typical Value = 1.25V)
T _{UVP}	Timing pin for under voltage protection blank-out time. Its threshold voltage is 1.8V and clamped at 2.9V after full charging. Target of delay time is 250ms and it is realized through external (C=2.2μF).
GND	Signal ground.
DTC	Dead time control input. The dead-time control comparator has an effective 120mV input offset which limits the minimum output dead time. Setting the dead time control input a fixed voltage, ranging between 0V to 3.3V may impose dead time on the output.
C2	Output driver 2 pin for push-pull operation.
E	Power ground.
C1	Output driver 1 pin for push-pull operation.

AP2101

Power-Housekeeping PWM Combo Controller



(Preliminary)

■ Absolute Maximum Rating

Characteristic	Symbol	Value	Unit
Supply Voltage	V_{CC}	40	V
Collector output voltage	V_{C1}, V_{C2}	40	V
Collector output current	I_{C1}, I_{C2}	200	mA
Power dissipation(AP2101)	P_D	0.8	W
Operating temperature	T_{OPR}	-25 to 85	°C
Storage temperature	T_{STG}	-65 to 150	°C

■ Temperature Characteristics

Characteristic	Symbol	Value			Unit
		Min.	Typ.	Max.	
Temperature coefficient of Vref ($-25^{\circ}\text{C} \leq T_a \leq 85^{\circ}\text{C}$)	$\Delta V_{ref} / \Delta T$	—	0.01	—	%/°C

■ Electrical Characteristics

(Unless otherwise noted, $V_{CC}=20V$, $T_A=25^{\circ}C$)

Characteristic	Symbol	Test Condition	Min.	Typ.	Max.	Unit
REFERENCE						
Reference output voltage	Vref	Iref=1mA	4.9	5	5.1	V
Line regulation	ΔV_{ref_LINE}	$14V \leq V_{CC} \leq 30V$	—	2.0	25	mV
Load regulation	Δv_{ref_LOAD}	$1mA \leq I_{ref} \leq 10mA$	—	1.0	15	mV
Temperature coefficient of Vref ⁽¹⁾	$\Delta V_{ref} / \Delta T$	$-25^{\circ}C \leq T_a \leq 85^{\circ}C$	—	0.01	—	%/°C
Short-circuit output current	I _{SC}	Vref=0	15	35	75	mA
OSCILLATOR						
Oscillation frequency	f _{OSC}	C _T =0.01μF, R _T =12k	—	10	—	kHz
Frequency change with temperature ⁽¹⁾	f _{OSC} /T	C _T =0.01μF, R _T =12k	—	2	—	%
DEAD TIME CONTROL						
Input bias current	I _{B(DT)}		—	-2.0	-10	μA
Maximum duty voltage	DC _{MAX}	Pin19(DTC)=0V	45	48	50	%
Input threshold voltage	V _{TH(DT)}	Zero Duty Cycle	—	3.0	3.3	V
		Max. Duty Cycle	0	—	—	
ERROR AMP						
Inverting reference voltage	Vref(EA)		1.20	1.25	1.30	V
Input bias current	I _{B(EA)}	V _{COMP} =2.5V	—	-0.1	-1.0	μA
Open-loop voltage gain ⁽¹⁾	G _{VO}	$0.5V \leq V_{COMP} \leq 3.5V$	70	95	—	dB
Unit-gain bandwidth ⁽¹⁾	BW		—	650	—	kHz
Output sink current	I _{SINK}	V _{COMP} =0.7V	0.3	0.9	—	mA
Output source current	I _{SOURCE}	V _{COMP} =3.5V	-2.0	-4.0	—	mA
PWM COMPARATOR						
Input threshold voltage	V _{TH(PWM)}	Zero Duty Cycle	—	4	4.5	V
OUTPUT						
Output saturation voltage	V _{CE(SAT)}	I _C =200mA	—	1.1	1.3	V
Collector off-state current	I _{C(off)}	V _{CC} =V _C =30V, V _E =0V	—	2	100	μA
Rising time	T _R		—	100	200	ns
Falling time	T _F		—	50	200	ns
PROTECTION						
Over voltage protection for 3.3V	V _{OVP1}		3.8	4.1	4.3	V
Over voltage protection for 5V	V _{OVP2}		5.8	6.2	6.6	V
Over voltage protection for 12V	V _{OVP3}		13.5	14.2	15.0	V
Over voltage protection for -5V	V _{OVP4}		-6.6	-6.2	-5.8	V
Over voltage protection for -12V	V _{OVP5}		-15.0	-14.2	-13.5	V
Input threshold voltage for PT	V _{PT}		1.20	1.25	1.30	V
Under voltage protection for 3.3V	V _{UVP1}		2.1	2.3	2.5	V
Under voltage protection for 5V	V _{UVP2}		3.7	4.0	4.3	V
Under voltage protection for 12V	V _{UVP3}		9.2	10	10.8	V
Under voltage protection for -5V	V _{UVP4}		-4.3	-4.0	-3.7	V
Under voltage protection for -12V	V _{UVP5}		-10.8	-10	-9.2	V

■ Electrical Characteristic (Continued)

Characteristic	Symbol	Test Condition	Min.	Typ.	Max.	Unit
Charging current for UVP delay	$I_{CHG.UVP}$	$C=2.2\mu F, V_{TH}=1.8V$	-10	-15	-23	μA
UVP Delay Time	$T_{D.UVP}$	$C=2.2\mu F$	100	260	500	ms
REMOTE ON/OFF						
REM on input voltage	V_{REMH}	$I_{REM}=-200\mu A$	2.0	—	—	V
REM off input voltage	V_{REML}	—	—	—	-0.8	V
REM off input bias voltage	I_{REML}	$V_{REM}=0.4V$	—	—	-1.6	mA
REM on open voltage	$V_{REM(OPEN)}$	—	2.0	—	5.25	V
REM on delay time	T_{on}	$C=0.1\mu F$	4	8	14	ms
REM off delay time	T_{off}	$C=0.1\mu F$	16	24	34	ms
REMOTE ON/OFF⁽²⁾						
Detecting input voltage	$V_{IN(DET)}$	—	1.20	1.25	1.30	V
Detecting V5 voltage	$V5_{(DET)}$	—	4.1	4.3	4.5	V
Hysteresis voltage 1	HY1	COMP1,2	10	40	80	mV
Hysteresis voltage 2	HY2	COMP3	0.6	1.2	—	V
PG output load resistor	R_{PG}	—	0.5	1	2	$k\Omega$
Charging current for PG delay	$I_{CHG.PG}$	$C=2.2\mu F, V_{TH}=1.8V$	-10	-15	-23	μA
PG delay time	$T_{D.PG}$	$C=2.2\mu F$	100	260	500	ms
PG output saturation voltage	$V_{SA(PG)}$	$I_{PG}=100mA$	—	0.2	0.4	V
TOTAL DEVICE						
Standby supply current	I_{CC}	—		10	20	mA

AP2101

Power-Housekeeping PWM Combo Controller



(Preliminary)

■ Application Circuit

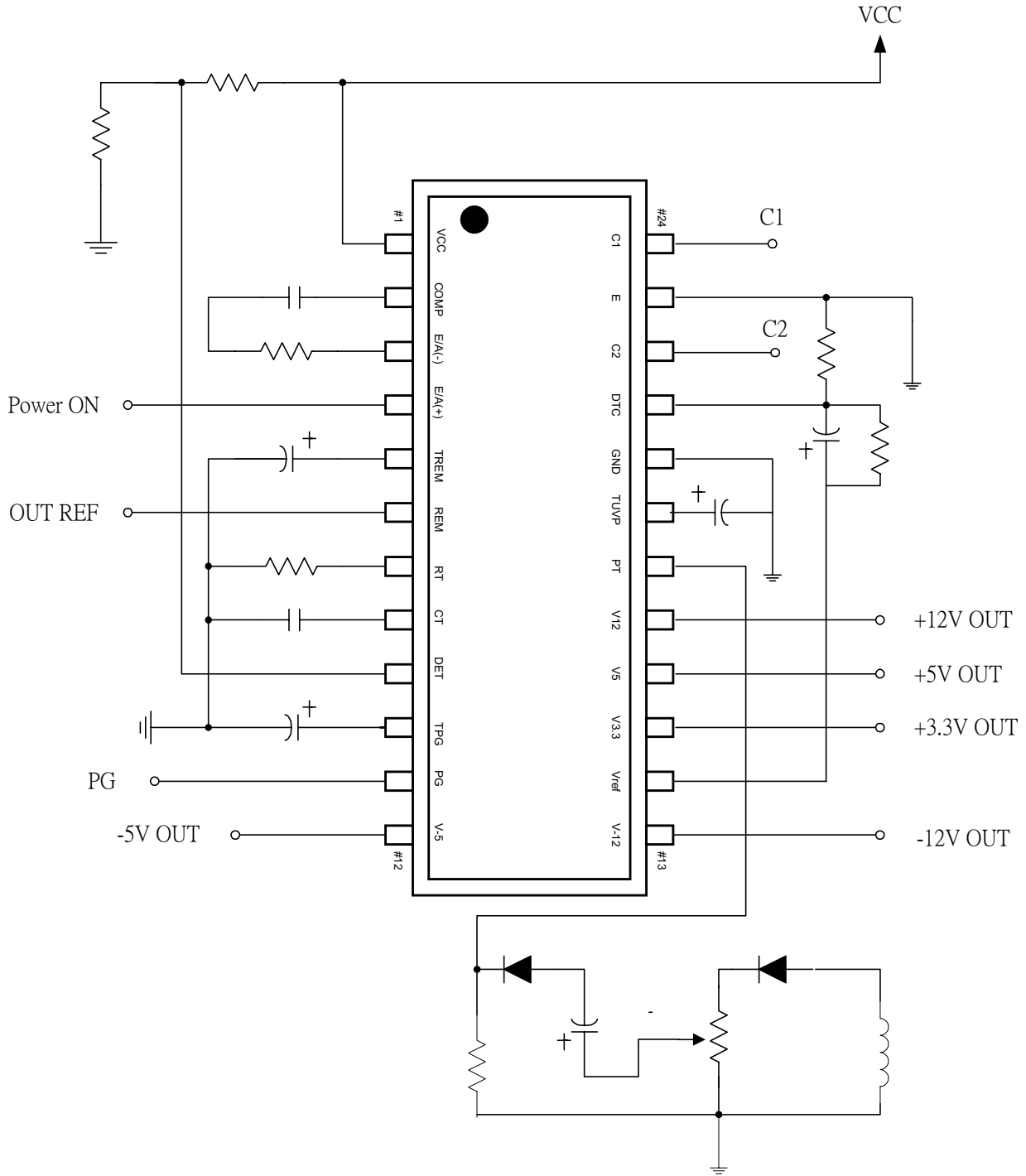

AP2101

Power-Housekeeping PWM Combo Controller



(Preliminary)

■ Package Dimension

Package Type: SOP-24L

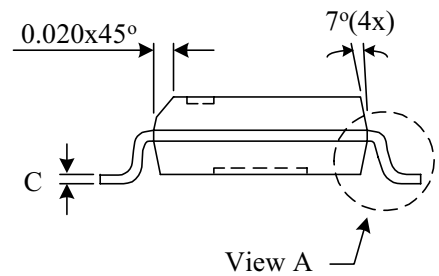
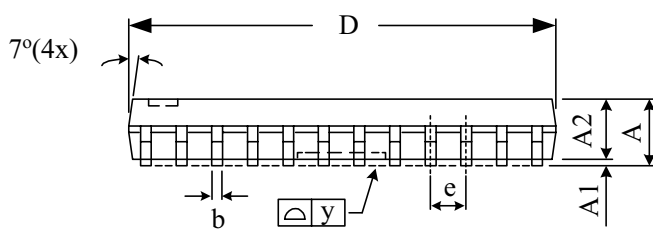
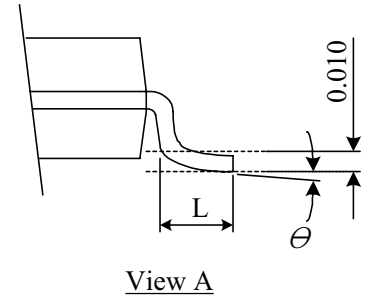
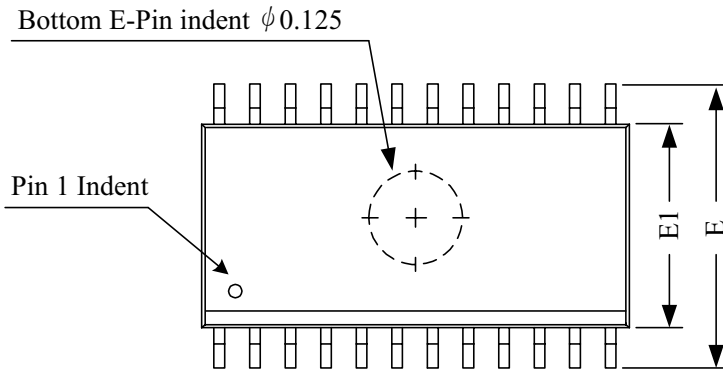

SYMBOLS	DIMENSIONS IN MILLIMETERS			DIMENSIONS IN INCHES		
	MIN	NOM	MAX	MIN	NOM	MAX
A	2.36	2.49	2.64	0.093	0.098	0.104
A1	0.10	—	0.30	0.004	—	0.012
A2	—	2.34	—	—	0.092	—
b	0.33	0.41	0.51	0.013	0.016	0.020
C	0.23	0.25	0.30	0.009	0.010	0.012
D	15.19	15.39	15.49	0.598	0.606	0.610
E	10.01	10.31	10.64	0.394	0.406	0.419
E1	7.39	7.49	7.59	0.291	0.295	0.299
e	—	1.27	—	—	0.050	—
L	0.38	0.81	1.27	0.015	0.032	0.050
y	—	—	0.076	—	—	0.003
θ	0	—	8	0	—	8