

AZ Displays, Inc.

1. MECHANICAL DATA

(1) Product No.	AGM1232C
(2) Module Size	66.1 (W)mm x 27.3 (H)mm x MAX8.4 (D)mm (W/O, EL B.L.)
(3) Dot Size	0.40 (W)mm x 0.45 (H)mm
(4) Dot Pitch	0.44 (W)mm x 0.49 (H)mm
(5) Number of Characters	122 (W) x 32 (H)Dots
(6) Duty	1/32
(7) LCD Display Mode	STN: <input type="checkbox"/> Gray Mode <input type="checkbox"/> Yellow Mode <input type="checkbox"/> Blue Mode FSTN: <input type="checkbox"/> Black and White(Normal White/Positive Image) <input type="checkbox"/> Black and White(Normal Black/Negative Image)
	Rear Polarizer: <input type="checkbox"/> Reflective <input type="checkbox"/> Transflective <input type="checkbox"/> Transmissive
(8) Viewing Direction	<input type="checkbox"/> 6 O'clock <input type="checkbox"/> 12 O'clock <input type="checkbox"/> ___O'clock
(9) Backlight	<input type="checkbox"/> W/O <input type="checkbox"/> LED B/L <input type="checkbox"/> EL B/L
(10) LCD Controller	SED1520
(11) Weight	W/O B/L: 17.5 g EL B/L: 19.0 g

AZ Displays, Inc.

2. ABSOLUTE MAXIMUM RATINGS

(1) ELECTRICAL ABSOLUTE RATINGS

V_{SS}=0V

	SYMBOL	MIN	MAX	UNIT	COMMENT
Power Supply for Logic	VDD-VSS	-0.3	6.5	V	
Input Voltage	V _I	-0.3	VDD	V	
Static Electricity	-	-	-		Note 1

Note 1 LCM should be grounded during handling

(2) ENVIRONMENTAL ABSOLUTE MAXIMUM RATINGS

ITEM	NORMAL TEMP.				WIDE TEMP.			
	OPERATING		STORAGE		OPERATING		STORAGE	
	MIN.	MAX.	MIN.	MAX.	MIN.	MAX.	MIN.	MAX.
Ambient Temperature	0	50	-20	70	-20	70	-30	80
Humidity (Without Condensation)	Note 1,3		Note 2,3		Note 3,4		Note 3,5	

Note 1 Ta \leq 50°C : 85%RH max
Ta > 50°C : Absolute humidity must be lower
than the humidity of 85%RH at 50°C

Note 2 Ta at -20°C will be < 48hrs, at 70°C will be < 120hrs

Note 3 Background color changes slightly depending on ambient temperature.
This phenomenon is reversible.

Note 4 Ta \leq 70°C : 75%RH max
Ta > 70°C : Absolute humidity must be lower
than the humidity of 75%RH at 70°C

Note 5 Ta at -30°C will be < 48hrs, at 80°C will be < 120hrs

AZ Displays, Inc.

3. ELECTRICAL CHARACTERISTICS

(VDD = 5V±10%)

ITEM	SYMBOL	CONDITION	MIN.	TYP.	MAX.	UNIT	
Input Voltage	VIH	H level	0.8VDD	–	VDD	V	
	VIO	L level	0	–	0.2VDD	V	
Recommended LC Driving Voltage (NORMAL TEMP. LCM)	VDD–V0	DUTY= 1/32 Bias= 1/4.7	0°C	–	6.0	6.8	V
			25°C	4.9	5.4	5.8	
			50°C	4.3	4.7	–	
Recommended LC Driving Voltage (WIDE TEMP. LCM)	VDD–V0	DUTY= 1/32 Bias= 1/4.7	–20°C	–	7.3	7.9	V
			0°C	–	–	–	
			25°C	6.6	7.0	7.5	
			50°C	–	–	–	
			70°C	5.9	6.4	–	
Power Supply Current	IDD	VDD = 5.0V	–	–	2.8	mA	
EL Power Supply Current	IEL	VBL = 110Vac 400Hz	–	–	5.0	mA	

AZ Displays, Inc.

4. OPTICAL CHARACTERISTICS

(FOR NORMAL TEMPERATURE MODE LCM)

AT Vop

MODE \ ITEM		Cr(Contrast Ratio)		θ (Viewing Angle)		ϕ (Viewing Angle)	
		25℃		25℃		25℃	
		MIN.	TYP.	MIN.	TYP.	MIN.	TYP.
R	A	3	4.5	40	70	25	34
	C	5	9	50	80	25	36
	J						
S	A	3	4	40	75	25	32
	C	4.5	9	40	70	25	30
	J						
T	E						
	G						
NOTE		NOTE6		NOTE5			

AT $\phi=0^\circ$ $\theta=0^\circ$

ITEM	SYMBOL	CONDITION	MIN.	TYP.	MAX.	UNIT	NOTE
Response Time (rise)	Tr	0℃	—	580	1200	ms	NOTE 2
		25℃	—	220	450		
		50℃	—	140	280		
Response Time (fall)	Tf	0℃	—	760	1500	ms	NOTE 2
		25℃	—	170	350		
		50℃	—	90	200		

NOTE :

- R: REFLECTIVE
- S: TRANSFLECTIVE
- T: TRANSMISSIVE
- A: GRAY
- C: YELLOW
- E: BLUE
- G: NORMALLY BLACK
- J: NORMALLY WHITE

AZ Displays, Inc.

4-1. OPTICAL CHARACTERISTICS

(FOR WIDE TEMPERATURE MODE LCM)

AT Vop

MODE \ ITEM		Cr(Contrast Ratio)		θ (Viewing Angle)		ϕ (Viewing Angle)	
		25℃		25℃		25℃	
		MIN.	TYP.	MIN.	TYP.	MIN.	TYP.
R	A	3	3.5	40	45	22	28
	C						
	J						
S	A	3	3.4	40	45	20	26
	C						
	J						
T	E						
	G						
NOTE		NOTE6		NOTE5			

AT $\phi=0^\circ$ $\theta=0^\circ$

ITEM	SYMBOL	CONDITION	MIN.	TYP.	MAX.	UNIT	NOTE
Response Time (rise)	Tr	-20℃	-	1100	2200	ms	NOTE 2
		0℃	-	-	-		
		25℃	-	105	210		
		50℃	-	-	-		
		70℃	-	40	80		
Response Time (fall)	Tf	-20℃	-	2400	4800	ms	NOTE 2
		0℃	-	-	-		
		25℃	-	160	320		
		50℃	-	-	-		
		70℃	-	55	110		

NOTE :

R: REFLECTIVE
 S: TRANSFLECTIVE
 T: TRANSMISSIVE
 A: GRAY

C: YELLOW
 E: BLUE
 G: NORMALLY BLACK
 J: NORMALLY WHITE

AZ Displays, Inc.

5. BLOCK DIAGRAM

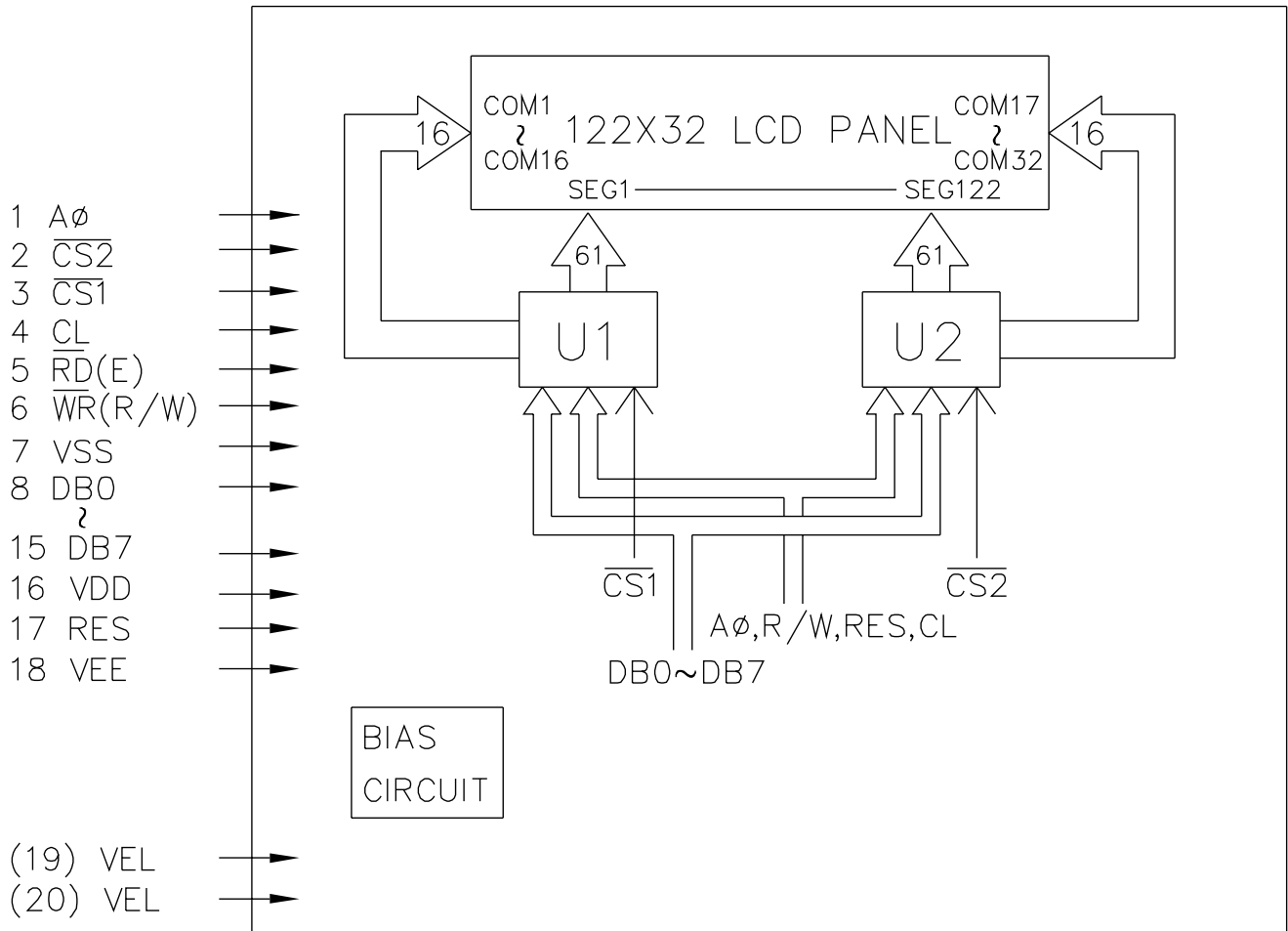

AZ Displays, Inc.

6. INTERNAL PIN CONNECTION

PinNo.	Symbol	Level	Function
1	A \emptyset	H/L	L→INSTRUCTION H→DATA
2	$\overline{CS2}$	L	CHIP ENABLE ACTIVE "L"
3	$\overline{CS1}$	L	CHIP ENABLE ACTIVE "L"
4	CL	H/L	EXTERNAL CLOCK(2KHZ)
5	$\overline{RD}(E)$	—	\overline{RD} FOR 80 SERIES,E FOR 68 SERIES
6	$\overline{WR}(R/W)$	—	\overline{WR} FOR 80 SERIES,R/W FOR 68SERIES
7	VSS	—	GROUND
8	DB0	H/L	DATA BUS LINE
9	DB1	H/L	
10	DB2	H/L	
11	DB3	H/L	
12	DB4	H/L	
13	DB5	H/L	
14	DB6	H/L	
15	DB7	H/L	
16	VDD	—	POWER SUPPLY FOR LOGIC CIRCUIT
17	RES	H/L	L→80 SERIES H→68 SERIES
18	VEE	—	POWER SUPPLY FOR LCD
(19)	VEL	—	POWER SUPPLY FOR EL BACK LIGHT
(20)	VEL	—	

AZ Displays, Inc.

7. POWER SUPPLY

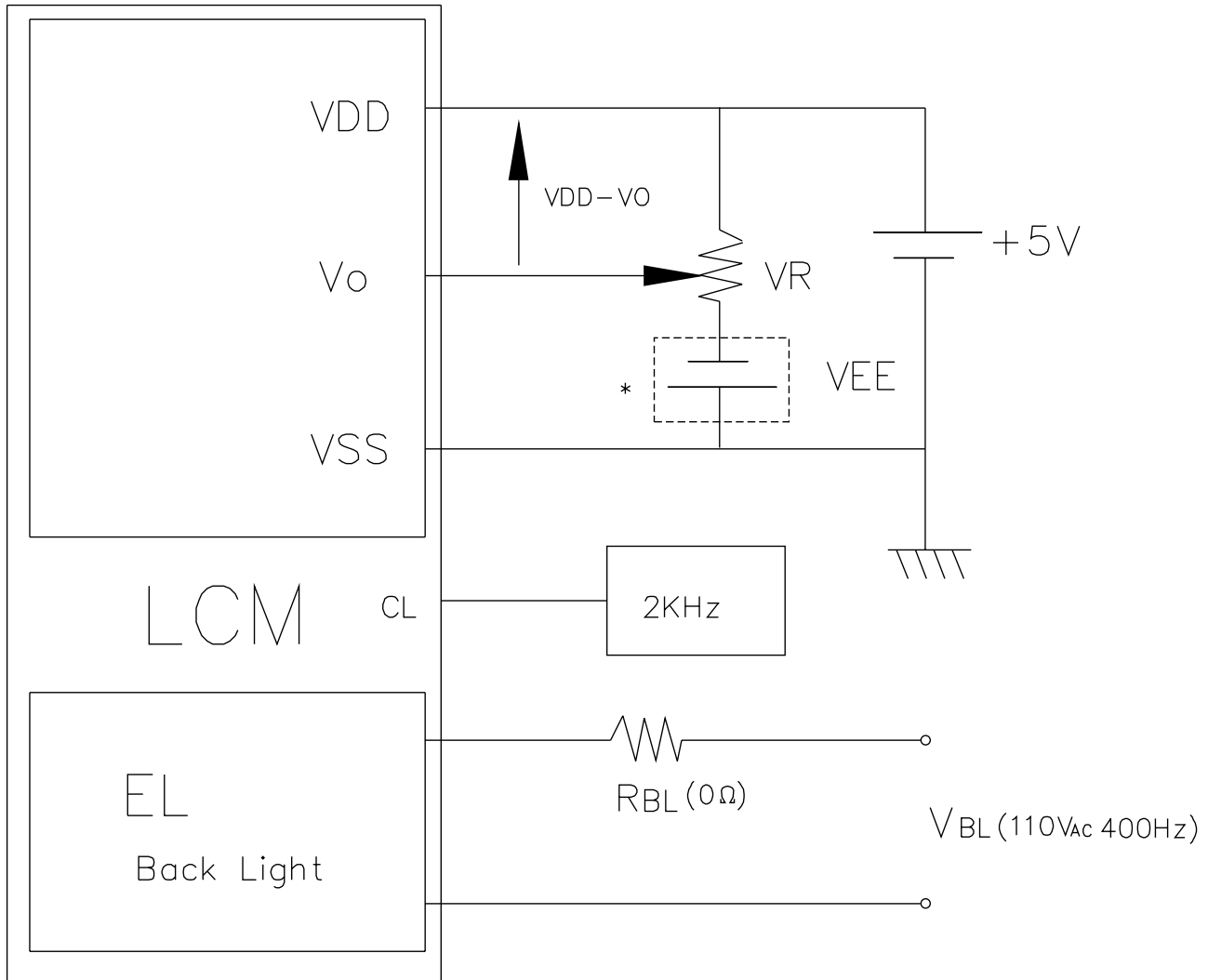

VR = 20KΩ (Variable)

* VEE = 5V

AZ Displays, Inc.

8. TIMING CHART

Item	Signal	Symbol	Condition	Min	Typ	Max	Unit
LOW pulse width	CL	tWLCL		35	-	-	μ s
HIGH pulse width		tWHCL		35	-	-	μ s
Rising time		t _r		-	30	150	ns
Falling time		t _f		-	30	150	ns
FR delay time	FR	tDFR	(Input timing)	-2.0	0.2	2.0	μ s
			(Output timing), CL=100pF		0.2	0.4	

○Read/write timing for the 68-port MPU

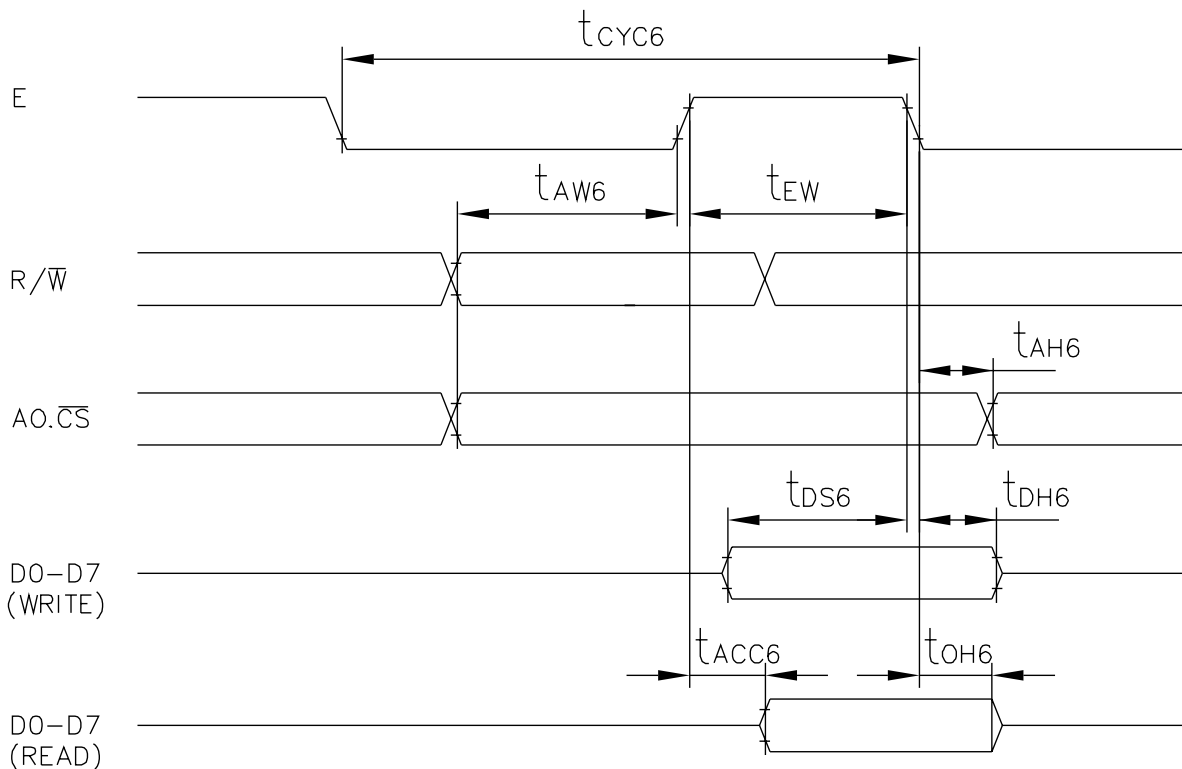

○Control timing for 80-port/68-port display

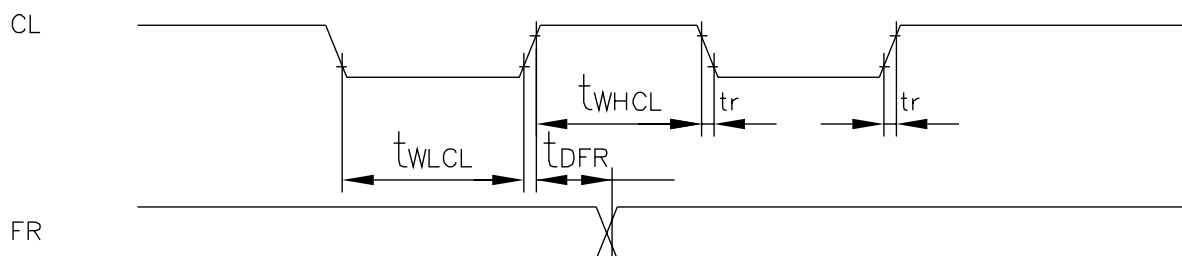

AZ Displays, Inc.

(NOTE 4)

Definition of Viewing Direction

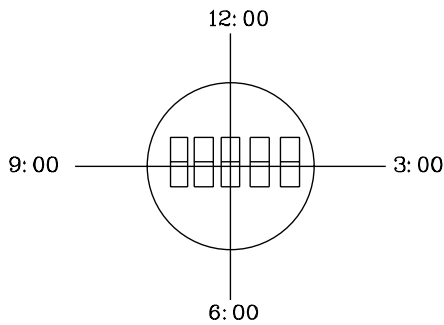

(NOTE 5)

Definition of Viewing Angle

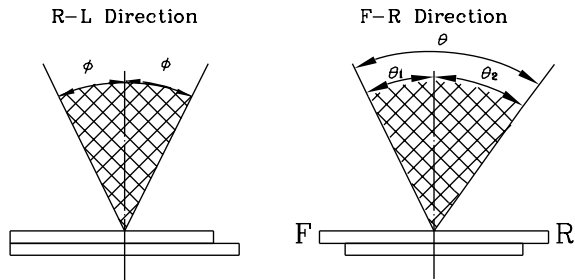

$$\theta = \theta_1 + \theta_2$$

*Conditions

- Operating Voltage : V_{op}
- Frame Frequency : 70Hz
- Applying Waveform : 1/N duty 1/a bias
- Contrast Ratio : larger than 2

(NOTE 6)

Definition of Contrast Ratio (Cr)

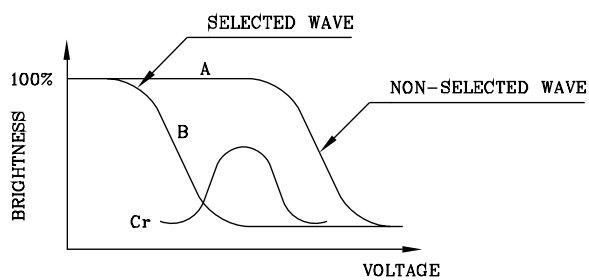

(positive type)

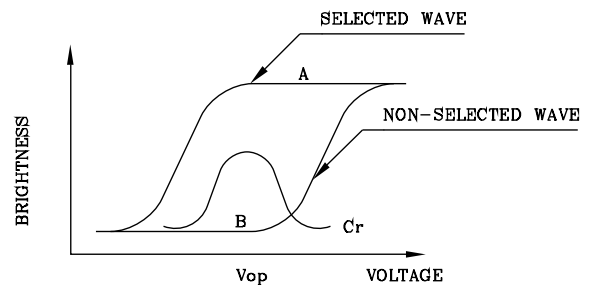

(negative type)

$$\text{Contrast Ratio : } Cr = A/B$$

*Conditions

- Viewing Angle : 0
- Frame Frequency : 70Hz
- Applying Waveform : 1/N duty 1/a bias

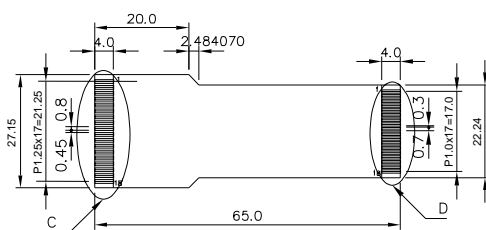
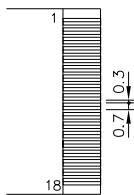
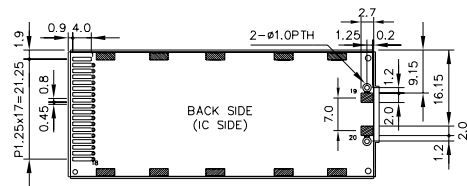
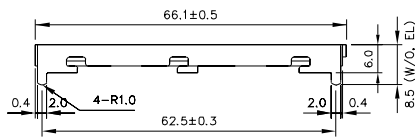
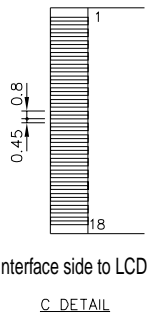
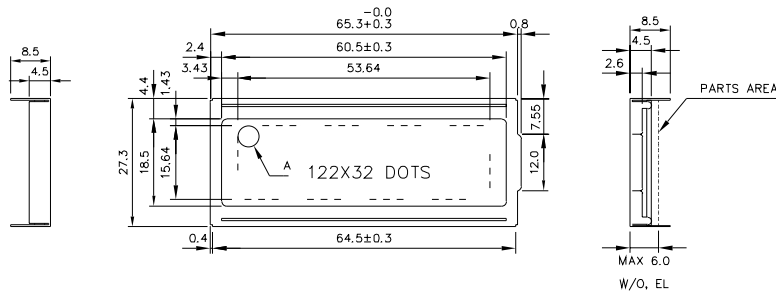

PinNo.	Symbol	Level	Function
1	A \emptyset	H/L	L→INSTRUCTION H→DATA
2	$\overline{CS}2$	L	CHIP ENABLE ACTIVE "L"
3	$\overline{CS}1$	L	CHIP ENABLE ACTIVE "L"
4	CL	H/L	EXTERNAL CLOCK(2KHZ)
5	RD(E)	-	\overline{RD} FOR 80 SERIES, E FOR 68 SERIES
6	$\overline{WR}(R/W)$	-	\overline{WR} FOR 80 SERIES, R/W FOR 68 SERIES
7	VSS	-	GROUND
8	DB0	H/L	DATA BUS LINE
9	DB1	H/L	
10	DB2	H/L	
11	DB3	H/L	
12	DB4	H/L	
13	DB5	H/L	
14	DB6	H/L	
15	DB7	H/L	
16	VDD	-	POWER SUPPLY FOR LOGIC CIRCUIT
17	RES	H/L	L→80 SERIES H→68 SERIES
18	VEE	-	POWER SUPPLY FOR LCD
19	NC	-	
20	NC	-	

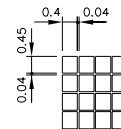

A. DETAIL

1. Resolution : 122X32 Dots

AGM1232C			AZ DISPLAYS, INC.		
APPROVE	NAME	DATE	TITLE		
CHECK			DWG-NO	MX-X042X1	Rev. A
DESIGN				UNIT : mm	
DRAW	MAY PING	85.03.01	SCALE : 1.5/3		