



Description

The B4300 series are a group of positive output voltage, three-pin regulators, which provide a high current even when the input/output voltage differential is small. Low power consumption and high accuracy is achieved through CMOS and programmable fuse technologies. Output voltage: 2.0V to 6.0V in 0.1V increments.

The B4300 consists of a high-precision voltage reference, an error correction circuit, and a current limited output driver.

Available in SOT-89 (300mW), and SOT-223 (500mW) packages minimizing the usage of board real state.

Features

- **Maximum output current: 300 mA.**
- **Highly accurate: Output voltage +/- 1.4%**
- **Extremely Low Ground Current 6 μ A**
- **CMOS low power consumption.**
- **Over-Current & Over-Temp. Protection**
- **Small input/output differential:**
0.3V @ 300mA
0.1V @ 100mA
- **Pin-to-Pin replacement for TC1108 & XC6203**
- **Offered in SOT-89 & SOT-223**

Applications

- **Battery Powered Equipment**
- **Notebook PC, Palmtops, PDA**
- **Portable Cameras and Video Recorders**
- **Reference Voltage Sources**

Pin Connection

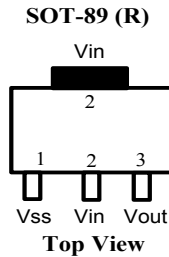
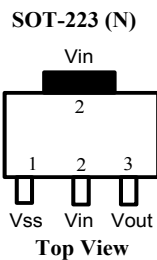
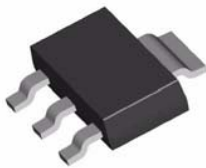

Ordering Information

Package	Part No.
SOT-89	B4300CR-X.X
SOT-223	B4300CN-X.X
X.X = Fixed Output Voltages from 2.0V to 6.0V	

Absolute Maximum Ratings

Parameter	Symbol	Ratings	Units
Input Voltage	V_{IN}	6.5	V
Output Current	I_{OUT}	300	mA
Output Voltage	V_{OUT}	$V_{SS} - 0.3$ to $V_{IN} - 0.3$	V
Continual Total Power Dissipation	P_d	300	mW
		SOT-89 SOT-223	
Operating Ambient Temperature	T_{OPR}	-30 to 80	°C
Storage Temperature	T_{STG}	-40 to 125	°C

Electrical Characteristics ($T_a = 25^\circ\text{C}$, $V_{IN} = V_{OUT} + 0.5\text{V}$; unless otherwise noted)

Parameter	Conditions	MIN	TYP	MAX	UNIT
Output Voltage	$I_O = 0\text{mA}$	-1.4%	-	+1.4%	V
	$I_O = 0$ to 300mA	-2%	-	+2%	
Line Regulation $\Delta V_{OUT}/\Delta V_{IN}$	$I_O = 100\text{mA}$, $(V_{OUT} + 0.1\text{V}) < V_{IN} < 6\text{V}$		0.2	0.3	%/V
Load Regulation	$V_{IN} = 6\text{V}$, $0\text{mA} < I_O < 300\text{mA}$ $C_{OUT} = \mu\text{F}$			0.04	%/mV
Maximum Output Current		300			mA
Current Limit		400			
Output Noise	$F = 10\text{KHz}$, $C_{out} = 1\mu\text{F}$, $R_{LOAD} = 50\Omega$		260		nV/ $\sqrt{\text{Hz}}$
Input Operation Voltage				6.0	V
Ground Pin Current	$I_{OUT} = 100\text{mA}$		2	6	μA
Dropout Voltage	$I_O = 100\text{mA}$		110	160	mV
	$I_O = 300\text{mA}$		270	480	
Thermal Shutdown Temperature			155		°C

Marking Format

 <p>D = B4300</p>		<p>SOT-89</p> <div style="border: 1px solid black; padding: 5px; width: fit-content; margin: 0 auto;"> <p>B4300 XZYWW</p> </div>	
Variables			
X = Voltage Codes	Z = Production Code	Y = Year	WW = Work Week Code
B = 2.0 F = 3.3 C = 2.5 G = 3.5 D = 2.8 H = 5.0 E = 3.0		01 = 2001 02 = 2002 03 = 2004 etc	SOT-23 = 01 to 99 SOT-89 = 01 to 52

PRODUCT DESCRIPTION

The B4300 is precision fixed output voltage regulator. Unlike bipolar regulators, the B4300 supply current does not increase with load current. In addition, V_{out} remains stable and within regulator at very low load currents (an important consideration in RTC and CMOS RAM battery back-up application).

Figure 1 shows a typical application circuit. The regulator is enabled any time the shutdown input is at or above V_{IH} . And shutdown (disabled) when SHDN is at or below V_{IL} . SHDN maybe controlled by a CMOS logic gate, or I/O port of a micro controller. If the SHDN input is not. Required, it should be connected directly to the supply. While in shutdown, supply current decreases to $0.05\mu A$ (typical) and V_{out} falls to zero volts.

Output Capacitor

A $1\mu F$ (min) capacitor from V_{out} to ground is required. Then output capacitor should have an effective series resistance of 5Ω or less. A $1\mu A$ capacitor should be connected from V_{in} to GND if there is more than 10 inches of wire between the regulator and the AC filter capacitor, or if a battery is used as the power source. Aluminum electrolytic or tantalum capacitor types can be used. (since many aluminum electrolytic capacitors freeze at approximately- $30^{\circ}C$, solid tantalums are recommended for applications operating below $-25^{\circ}C$.) When operating from sources other than batteries, supply-noise rejection and transient response can be improved by increasing the value of the input and output capacitors and employing passive filtering techniques.

Thermal Considerations

Thermal Shutdown

Integrated thermal protection circuitry shuts the regulator off when die temperature exceeds $160^{\circ}C$. The regulator remaining off until the die temperature drops to approximately $140^{\circ}C$.

Power Dissipation

The amount of power the regulator dissipates is primarily a function of input and output voltage, and output current. The following equation is used to calculate worst case power dissipation:

$$P_D = (V_{INMAX} - V_{OUTMIN}) I_{LOADMAX}$$

Where:

P_D = worst case actual power dissipation

V_{INMAX} = Maximum voltage on V_{IN}

V_{OUTMIN} = Minimum regulator output voltage

$I_{LOADMAX}$ = maximum output (LOAD) Current

The maximum allowable power dissipation is function of the maximum ambient temperature (T_{AMAX}). The maximum allowable die temperature ($125^{\circ}C$) and the thermal resistance from junction-to-air (θ_{JA}).

$$P_{DMAX} = (T_{JMAX} - T_{AMAX}) / \theta_{JA}$$

Where all terms are previously defined

This can be caused in conjunction with other equation to ensure regulator thermal operation is within limit. For example:

Given:

$$V_{INMAX} = 3.3V + 10\%$$

$$V_{OUTMIN} = 2.7V - 2.5\%$$

$$I_{LOADMAX} = 275 \text{ mA}$$

$$T_{JMAX} = 125^{\circ}C$$

$$T_{AMAX} = 95^{\circ}C$$

$$\theta_{JA} = 59^{\circ}C/W$$

Find:

1. Actual power dissipation
2. Maximum allowable dissipation

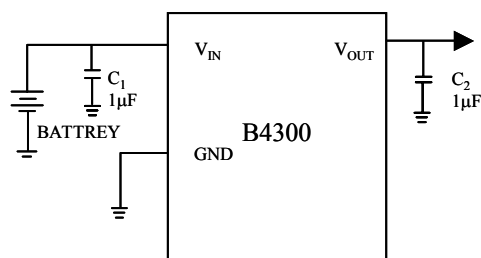

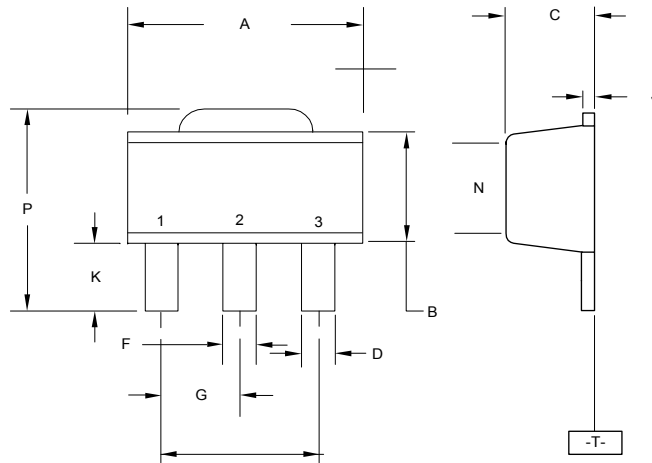

- | | |
|---|--|
| <p>STYLE 1
PIN 1. BASE
2. COLLECTOR
3. EMITTER</p> | <p>STYLE 3
PIN 1. GATE
2. ANODE
3. CATHODE</p> |
| <p>STYLE 2
PIN 1. ANODE
2. CATHODE
3. NO CONNECTION</p> | <p>STYLE 4
PIN 1. DRAIN
2. GATE
3. SOURCE</p> |

DIM	MILLIMETERS		INCHES	
	MIN	MAX	MIN	MAX
A	4.40	4.60	0.174	0.181
B	2.29	2.60	0.091	0.102
C	140	160	0.056	0.062
D	0.36	0.48	0.015	0.018
E	1.62	1.80	0.064	0.070
F	0.44	0.53	0.018	0.020
G	150 BSC		0.059 BSC	
J	0.35	0.44	0.014	0.017
K	0.80	1.04	0.032	0.040
L	300 BSC		0.118 BSC	
N	2.04	2.28	0.081	0.089
P	3.94	4.25	0.156	0.167

7.0 SOT-223

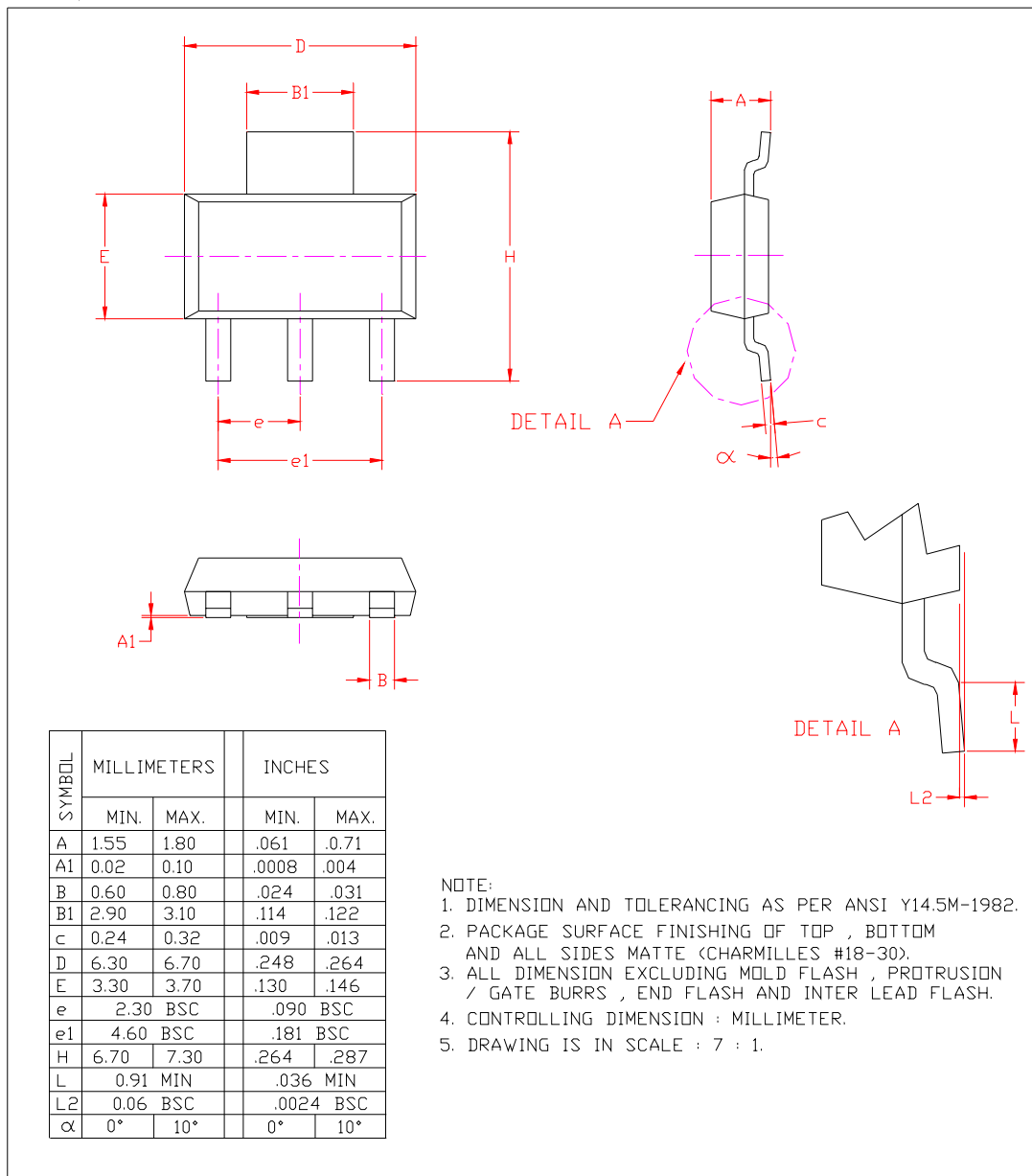

Advance Information- These data sheets contain descriptions of products that are in development. The specifications are based on the engineering calculations, computer simulations and/ or initial prototype evaluation.

Preliminary Information- These data sheets contain minimum and maximum specifications that are based on the initial device characterizations. These limits are subject to change upon the completion of the full characterization over the specified temperature and supply voltage ranges.

The application circuit examples are only to explain the representative applications of the devices and are not intended to guarantee any circuit design or permit any industrial property right to other rights to execute. Bay Linear takes no responsibility for any problems related to any industrial property right resulting from the use of the contents shown in the data book. Typical parameters can and do vary in different applications. Customer's technical experts must validate all operating parameters including " Typical" for each customer application.

LIFE SUPPORT AND NUCLEAR POLICY

Bay Linear products are not authorized for and should not be used within life support systems which are intended for surgical implants into the body to support or sustain life, in aircraft, space equipment, submarine, or nuclear facility applications without the specific written consent of Bay Linear President.
