



ADS7861

Dual, 500kHz, 12-Bit, 2 + 2 Channel, Simultaneous Sampling ANALOG-TO-DIGITAL CONVERTER

FEATURES

- 4 INPUT CHANNELS
- FULLY DIFFERENTIAL INPUTS
- 2 μ s TOTAL THROUGHPUT PER CHANNEL
- GUARANTEED NO MISSING CODES
- 1MHz EFFECTIVE SAMPLING RATE
- LOW POWER: 40mW
- SSI SERIAL INTERFACE

APPLICATIONS

- MOTOR CONTROL
- MULTI-AXIS POSITIONING SYSTEMS
- 3-PHASE POWER CONTROL

DESCRIPTION

The ADS7861 is a dual, 12-bit, 500kHz, analog-to-digital converter with 4 fully differential input channels grouped into two pairs for high speed, simultaneous signal acquisition. Inputs to the sample-and-hold amplifiers are fully differential and are maintained differential to the input of the A/D converter. This provides excellent common-mode rejection of 80dB at 50kHz which is important in high noise environments.

The ADS7861 offers a high speed, dual serial interface and control inputs to minimize software overhead. The output data for each channel is available as a 12-bit word. The ADS7861 is offered in a 24-lead SSOP package and is fully specified over the -40°C to $+85^{\circ}\text{C}$ operating range.

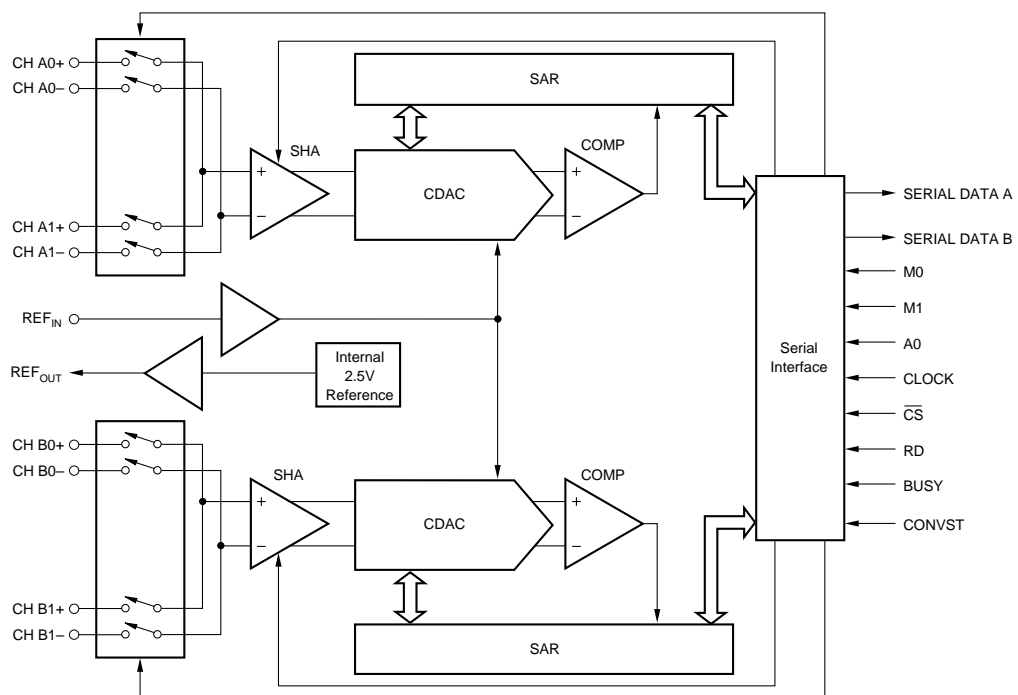

International Airport Industrial Park • Mailing Address: PO Box 11400, Tucson, AZ 85734 • Street Address: 6730 S. Tucson Blvd., Tucson, AZ 85706 • Tel: (520) 746-1111
Twx: 910-952-1111 • Internet: <http://www.burr-brown.com/> • Cable: BBRCORP • Telex: 066-6491 • FAX: (520) 889-1510 • Immediate Product Info: (800) 548-6132

SPECIFICATIONS

All specifications T_{MIN} to T_{MAX} , $+V_A + V_D = +5V$, and $V_{REF} = \text{internal } +2.5V$, $f_{CLK} = 8MHz$, $f_{SAMPLE} = 500kHz$, unless otherwise noted.

PARAMETER	CONDITIONS	ADS7861E			ADS7861EB			UNITS
		MIN	TYP	MAX	MIN	TYP	MAX	
RESOLUTION				12			*	Bits
ANALOG INPUT Input Voltage Range-Bipolar Input Capacitance Input Leakage Current	$V_{CENTER} = \text{Internal } V_{REF} \text{ at } 2.5V$	$-V_{REF}$	15 ± 1	$+V_{REF}$	*	*	*	V pF μA
SYSTEM PERFORMANCE No Missing Codes Integral Linearity Integral Linearity Match Differential Linearity Bipolar Offset Error Bipolar Offset Error Match Positive Gain Error Positive Gain Error Match Negative Gain Error Negative Gain Error Match Common-Mode Rejection Ratio Noise Power Supply Rejection Ratio	Referenced to REF_{IN} Referenced to REF_{IN} Referenced to REF_{IN} At DC $V_{IN} = \pm 1.25Vp-p$ at 50kHz	12	± 0.75 0.5 ± 1 ± 0.5 3 ± 0.15 ± 0.15 80 80 120 0.5	± 2 ± 1 ± 3 2 ± 0.75 2 2	*	± 0.5 * ± 0.5 * * ± 0.10 ± 0.10 * * *	± 1 * ± 1 * 2 ± 0.50 1 ± 0.50 1	Bits LSB LSB LSB LSB LSB % of FSR LSB % of FSR LSB dB dB μV_{rms} LSB
SAMPLING DYNAMICS Conversion Time per A/D Acquisition Time Throughput Rate Aperture Delay Aperture Delay Matching Aperture Jitter Small-Signal Bandwidth		500	1.625 0.375 3.5 100 50 40		*	*	*	μs μs kHz ns ps ps MHz
DYNAMIC CHARACTERISTICS Total Harmonic Distortion SINAD Spurious Free Dynamic Range Channel-to-Channel Isolation	$V_{IN} = \pm 2.5Vp-p$ at 100kHz $V_{IN} = \pm 2.5Vp-p$ at 100kHz $V_{IN} = \pm 2.5Vp-p$ at 100kHz $V_{IN} = \pm 2.5Vp-p$ at 100kHz	70 72		-72 -80	*		-76 *	dB dB dB dB
VOLTAGE REFERENCE Internal Internal Drift Internal Noise Internal Source Current Internal Load Rejection Internal PSRR External Voltage Range Input Current Input Capacitance		2.475	2.5 ± 25 50 2 0.005 80	2.525	*	*	*	V ppm/ $^{\circ}C$ $\mu Vp-p$ mA mV/ μA dB
DIGITAL INPUT/OUTPUT Logic Family Logic Levels: V_{IH} V_{IL} V_{OH} V_{OL} External Clock, Optional Data Format	$I_{IH} = +5\mu A$ $I_{IL} = +5\mu A$ $I_{OH} = 2 \text{ CMOS Loads}$ $I_{OL} = 2 \text{ CMOS Loads}$	3.0 -0.3 3.5 0.2	CMOS	$+V_{DD} + 0.3$ 1 0.4 8	*	*	*	V V V V MHz
POWER SUPPLY REQUIREMENTS Power Supply Voltage, +V Quiescent Current, +V _A Power Dissipation		4.75	5 5 25	5.25 8 40	*	*	*	V mA mW

* Specifications same as ADS7861E.

The information provided herein is believed to be reliable; however, BURR-BROWN assumes no responsibility for inaccuracies or omissions. BURR-BROWN assumes no responsibility for the use of this information, and all use of such information shall be entirely at the user's own risk. Prices and specifications are subject to change without notice. No patent rights or licenses to any of the circuits described herein are implied or granted to any third party. BURR-BROWN does not authorize or warrant any BURR-BROWN product for use in life support devices and/or systems.

PIN CONFIGURATION

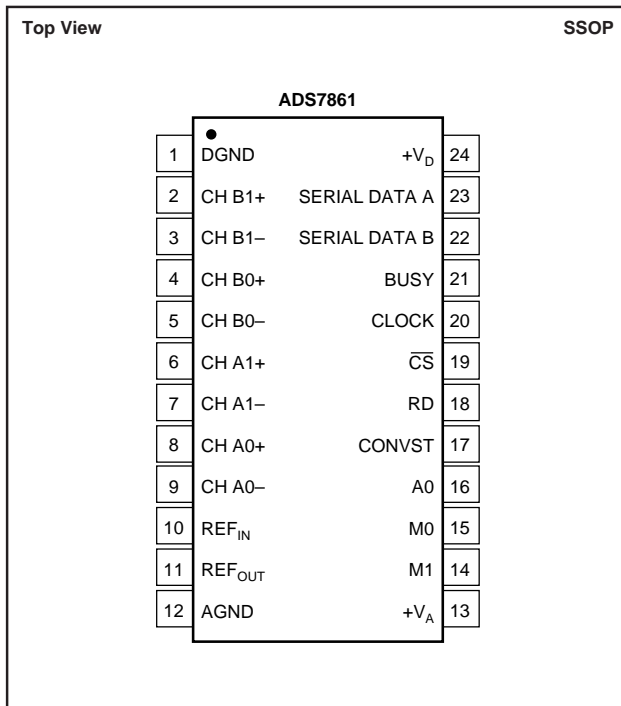

ABSOLUTE MAXIMUM RATINGS

Analog Inputs to AGND, Any Channel Input	-0.3V to (+V _D + 0.3V)
REF _{IN}	-0.3V to (+V _D + 0.3V)
Digital Inputs to DGND	-0.3V to (+V _D + 0.3V)
Ground Voltage Differences: AGND, DGND	±0.3V
$+V_D$ to AGND	-0.3V to +6V
Power Dissipation	325mW
Maximum Junction Temperature	+150°C
Operating Temperature Range	-40°C to +85°C
Storage Temperature Range	-65°C to +150°C
Lead Temperature (soldering, 10s)	+300°C



ELECTROSTATIC DISCHARGE SENSITIVITY

This integrated circuit can be damaged by ESD. Burr-Brown recommends that all integrated circuits be handled with appropriate precautions. Failure to observe proper handling and installation procedures can cause damage.

ESD damage can range from subtle performance degradation to complete device failure. Precision integrated circuits may be more susceptible to damage because very small parametric changes could cause the device not to meet its published specifications.

PIN DESCRIPTIONS

PIN	NAME	DESCRIPTION
1	DGND	Digital Ground. Connect directly to analog ground (pin 12).
2	CH B1+	Non-Inverting Input Channel B1
3	CH B1-	Inverting Input Channel B1
4	CH B0+	Non-Inverting Input Channel B0
5	CH B0-	Inverting Input Channel B0
6	CH A1+	Non-Inverting Input Channel A1
7	CH A1-	Inverting Input Channel A1
8	CH A0+	Non-Inverting Input Channel A0
9	CH A0-	Inverting Input Channel A0
10	REF _{IN}	Reference Input
11	REF _{OUT}	2.5V Reference Output
12	AGND	Analog Ground. Connect directly to digital ground (pin 1).
13	$+V_A$	Analog Power Supply, +5VDC. Connect directly to digital power supply (pin 24). Decouple to analog ground with a 0.1μF ceramic capacitor and a 10μF tantalum capacitor.
14	M1	Selects between the Serial Outputs. When M1 is LOW, both Serial Output A and Serial Output B are selected for data transfer. When M1 is HIGH, Serial output A is configured for both Channel A data and Channel B data; Serial Output B goes into tri-state (i.e., high impedance).
15	M0	Selects between two-channel and four-channel operation. When M0 is LOW, two-channel operation is selected and operates in conjunction with A0. When A0 is HIGH, Channel A1 and Channel B1 are being converted. When A0 is LOW, Channel A0 and Channel B0 are being converted. When M0 is HIGH, four-channel operation is selected. In this mode, all four channels are converted in sequence starting with Channels A0 and B0, followed by Channels A1 and B1.
16	A0	A0 operates in conjunction with M0. With M0 LOW and A0 HIGH, Channel A1 and Channel B1 are converted. With M0 LOW and A0 LOW, Channel A0 and Channel B0 are converted.
17	CONVST	Convert Start. When CONVST switches from LOW to HIGH, the device switches from the sample to hold mode, independent of the status of the external clock.
18	RD	Synchronization Pulse for the Serial Output.
19	\overline{CS}	Chip Select. When LOW, the Serial Output A and Serial Output B outputs are active; when HIGH, the serial outputs are tri-stated.
20	CLOCK	An external CMOS-compatible clock can be applied to the CLOCK input to synchronize the conversion process to an external source. The CLOCK pin controls the sampling rate by the equation: $CLOCK = 16 \cdot f_{SAMPLE}$.
21	BUSY	BUSY goes HIGH during a conversion and returns LOW after the third LSB has been transmitted on either the Serial A or Serial B output pin.
22	SERIAL DATA B	The Serial Output data word is comprised of channel information and 12 bits of data. In operation, data is valid on the falling edge of DCLOCK for 16 edges after the trailing edge of the RD.
23	SERIAL DATA A	The Serial Output data word is comprised of channel information and 12 bits of data. In operation, data is valid on the falling edge of DCLOCK for 16 edges after the trailing edge of the RD. When M1 is HIGH, both Channel A data and Channel B data are available.
24	$+V_D$	Digital Power Supply, +5VDC. Connect directly to pin 13. Must be $\leq +V_A$.

PACKAGE/ORDERING INFORMATION

PRODUCT	MINIMUM RELATIVE ACCURACY (LSB)	MAXIMUM GAIN ERROR (%)	SPECIFICATION TEMPERATURE RANGE	PACKAGE	PACKAGE DRAWING NUMBER ⁽¹⁾	ORDERING NUMBER ⁽²⁾	TRANSPORT MEDIA
ADS7861E	±2	±0.75	-40°C to +85°C	24-Lead SSOP	352	ADS7861E	Rails
"	"	"	"	"	"	ADS7861EB/2K5	Tape and Reel
ADS7861EB	±1	±0.5	-40°C to +85°C	24-Lead SSOP	352	ADS7861E	Rails
"	"	"	"	"	"	ADS7861EB/2K5	Tape and Reel

NOTES: (1) For detailed drawing and dimension table, please see end of data sheet, or Appendix C of Burr-Brown IC Data Book. (2) Models with a slash (/) are available only in Tape and Reel in the quantities indicated (e.g., /2K indicates 2000 devices per reel). Ordering 2000 pieces of "ADS7861E/2K" will get a single 2000-piece Tape and Reel. For detailed Tape and Reel mechanical information, refer to Appendix B of Burr-Brown IC Data Book.

TRUTH TABLE

M0	M1	A0	TWO-CHANNEL/FOUR-CHANNEL OPERATION	DATA ON SERIAL OUTPUTS	CHANNELS CONVERTED
0	0	0	Two Channel	A and B	A0, B0
0	0	1	Two Channel	A and B	A1, B1
0	1	0	Two Channel	A Only	A0, B0
0	1	1	Two Channel	A Only	A1, B1
1	0	X	Four Channel	A and B	Sequential
1	1	X	Four Channel	A Only	Sequential

X = Don't Care.

BASIC CIRCUIT CONFIGURATION

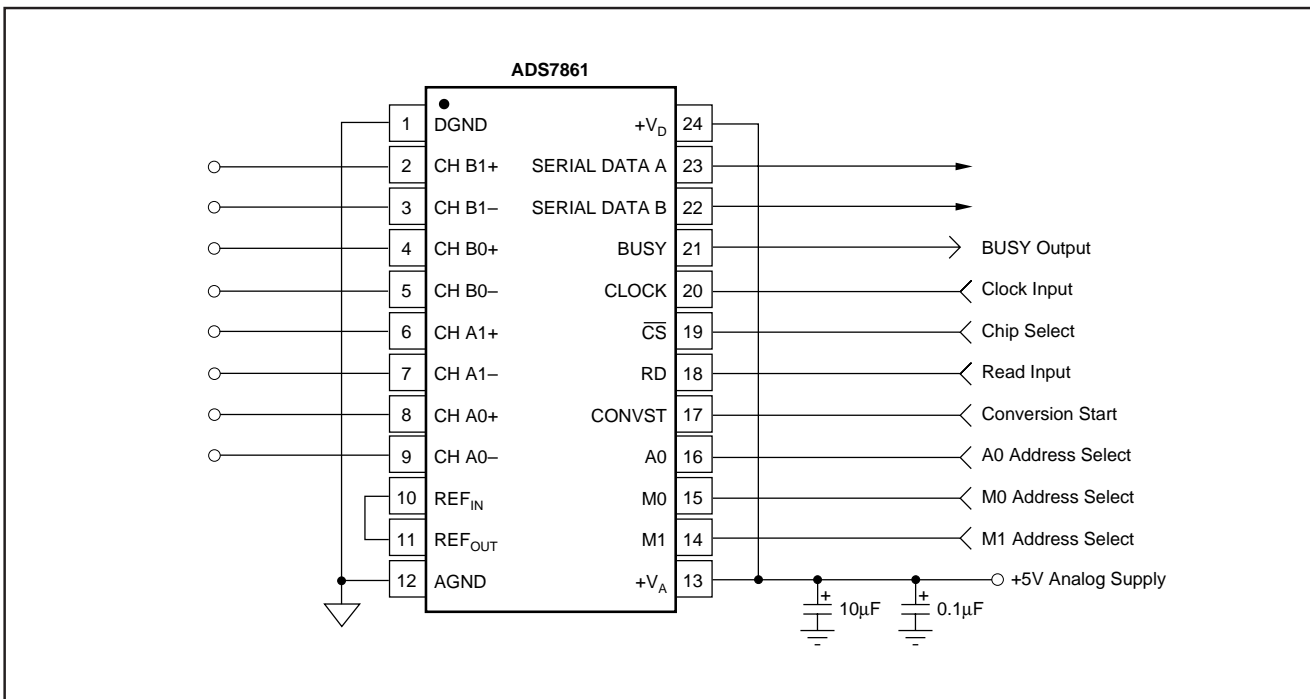

TYPICAL PERFORMANCE CURVES

At $T_A = +25^\circ\text{C}$, $V_A + V_D = +5\text{V}$, and $V_{REF} = \text{internal } +2.5\text{V}$, $f_{CLK} = 8\text{MHz}$, $f_{SAMPLE} = 500\text{kHz}$, unless otherwise noted.

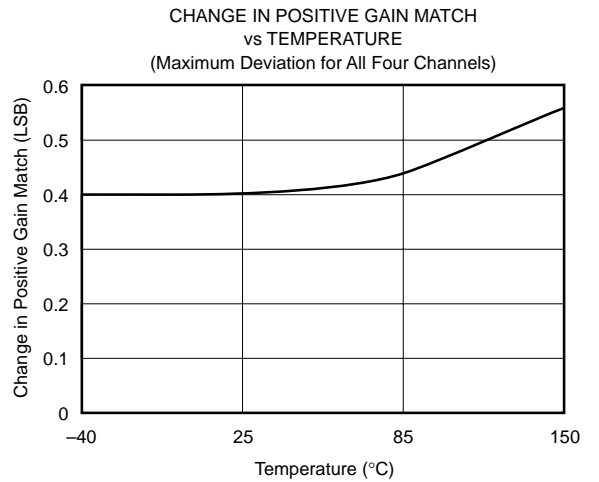
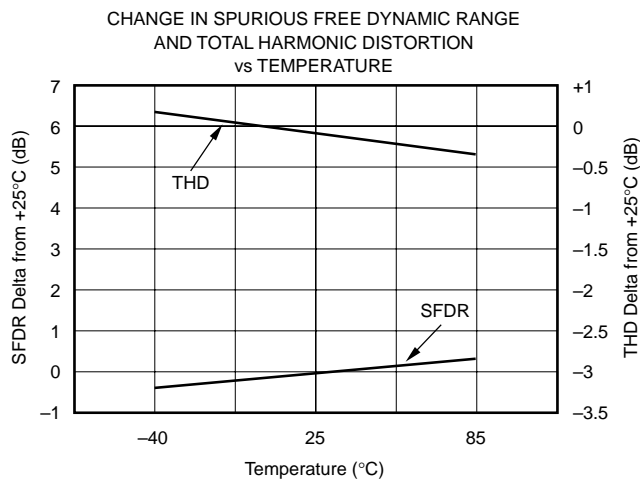
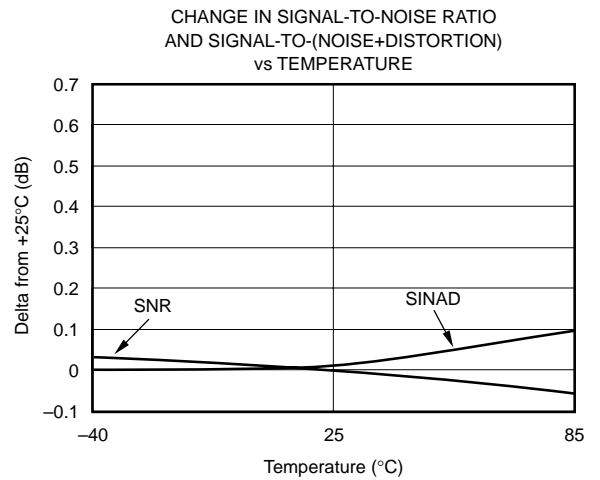
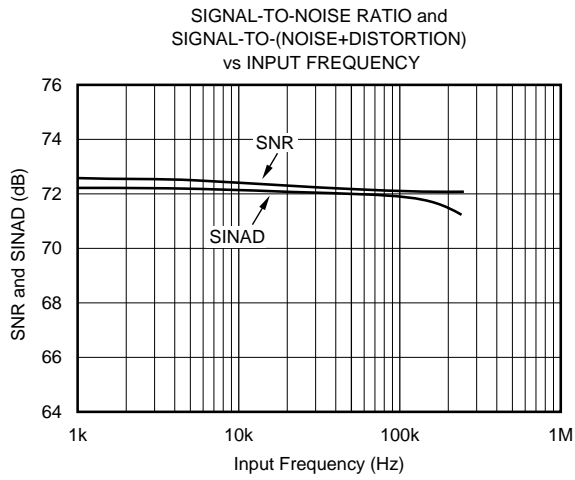
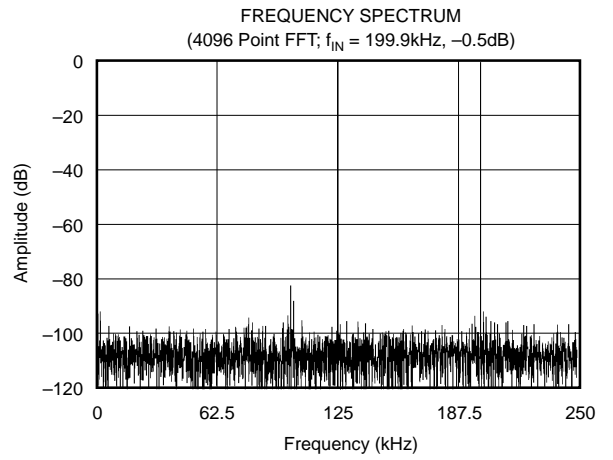
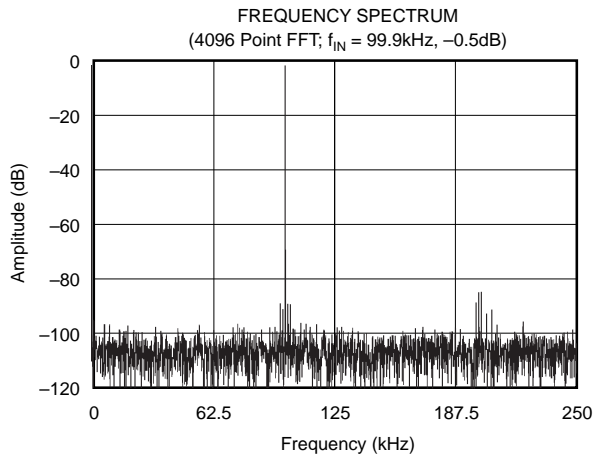

TYPICAL PERFORMANCE CURVES (CONT)

At $T_A = +25^\circ\text{C}$, $+V_A + V_D = +5\text{V}$, and $V_{\text{REF}} = \text{internal } +2.5\text{V}$, $f_{\text{CLK}} = 8\text{MHz}$, $f_{\text{SAMPLE}} = 500\text{kHz}$, unless otherwise noted.

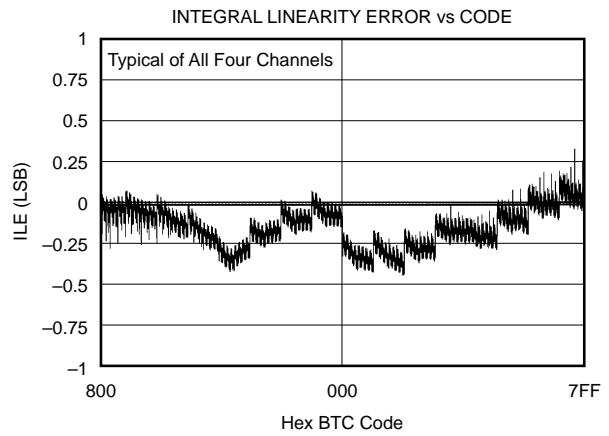
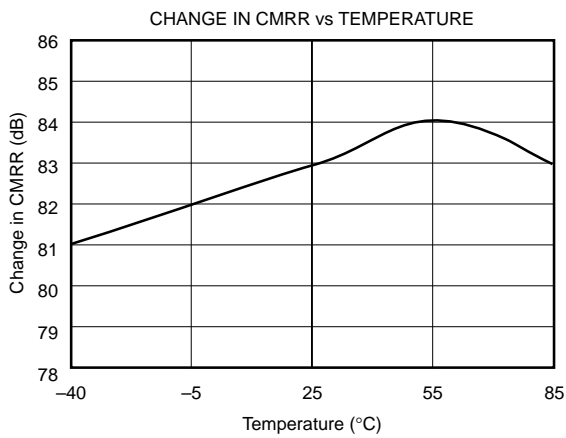
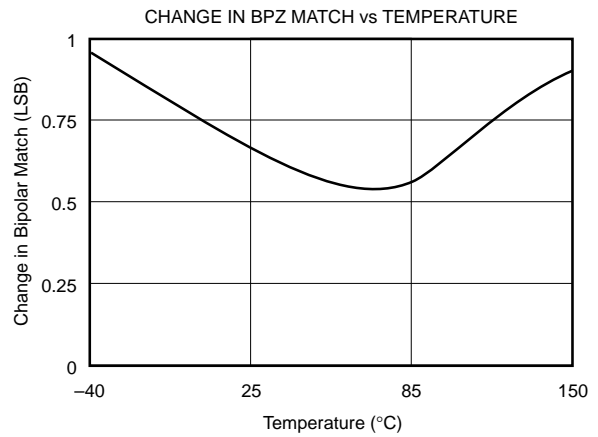
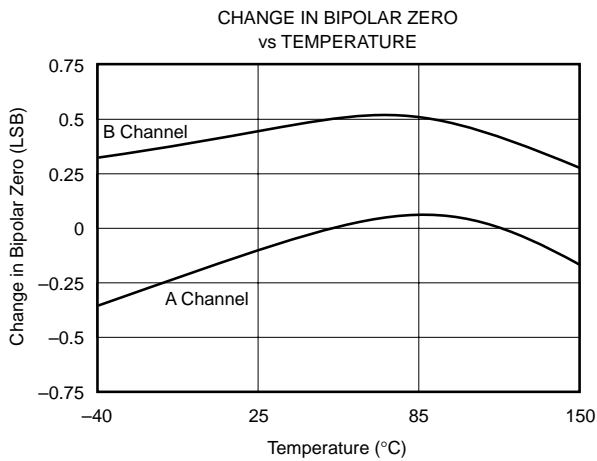
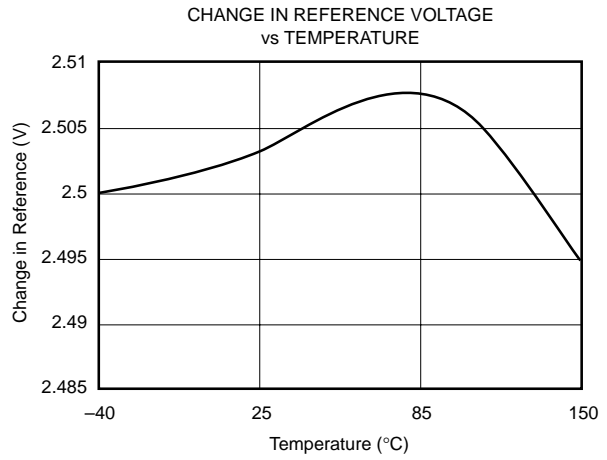
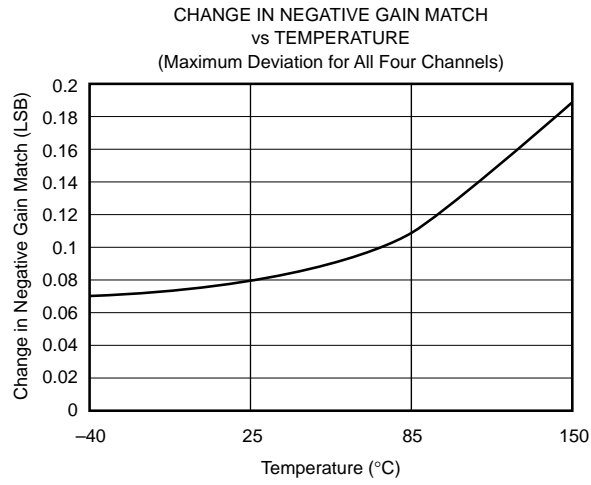

TYPICAL PERFORMANCE CURVES (CONT)

At $T_A = +25^\circ\text{C}$, $V_A + V_D = +5\text{V}$, and $V_{REF} = \text{internal } +2.5\text{V}$, $f_{CLK} = 8\text{MHz}$, $f_{SAMPLE} = 500\text{kHz}$, unless otherwise noted.

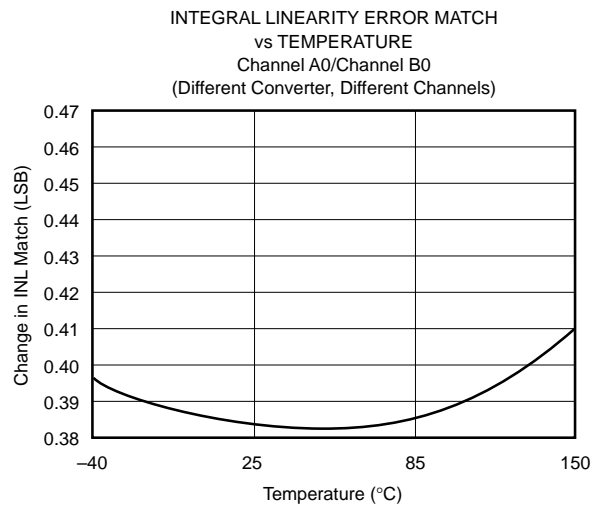
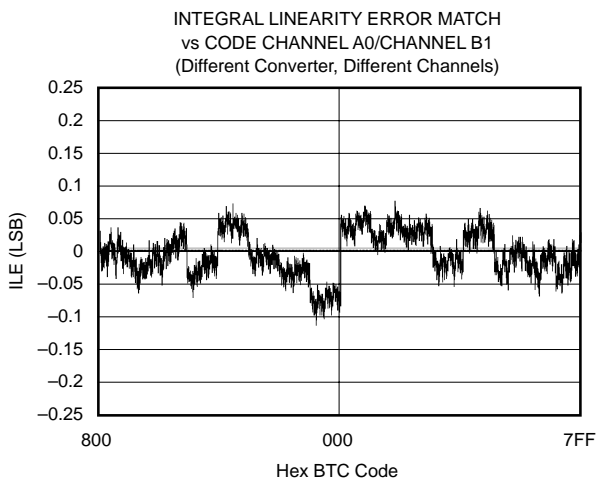
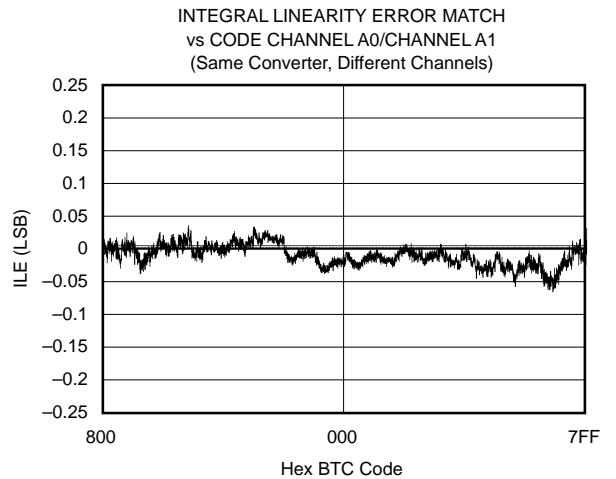
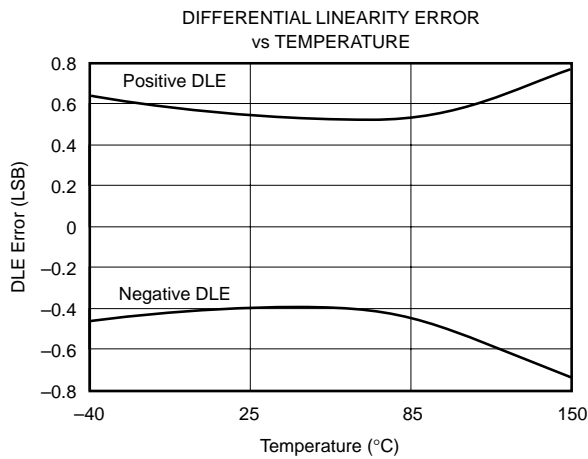
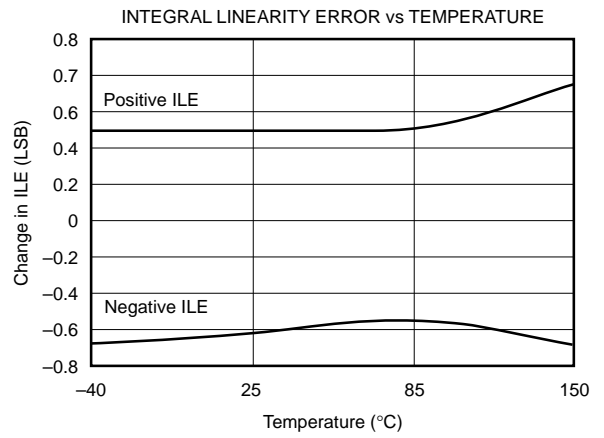
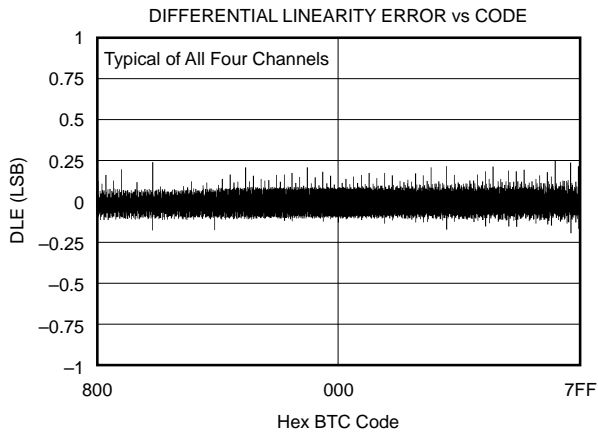

INTRODUCTION

The ADS7861 is a high speed, low power, dual, 12-bit A/D converter that operates from a single +5V supply. The input channels are fully differential with a typical common-mode rejection of 80dB. The part contains dual, 2 μ s successive approximation ADCs, two differential sample-and-hold amplifiers, an internal +2.5V reference with REF_{IN} and REF_{OUT} pins and a high-speed parallel interface. The ADS7861 requires an external clock. In order to achieve the maximum throughput rate of 500kHz, the master clock must be set at 8MHz. A minimum of 16 clock cycles are required for each 12-bit conversion.

There are four analog inputs that are grouped into two channels (A and B). Channel selection is controlled by the M0 (pin 14), M1 (pin 15) and A0 (pin 16) pins. Each channel has two inputs (A0 and A1 and B0 and B1) that can be sampled and converted simultaneously, thus preserving the relative phase information of the signals on both analog inputs. The part accepts an analog input voltage in the range of $-V_{REF}$ to $+V_{REF}$, centered around the internal +2.5V reference. The part will also accept bipolar input ranges when a level shift circuit is used at the front end (see Figure 7).

All conversions are initiated on the ADS7861 by bringing the CONVST pin HIGH for a minimum of 15ns. CONVST HIGH places both sample-and-hold amplifiers in the hold state simultaneously and the conversion process is started on both channels. The RD pin (pin 18) can be connected to CONVST to simplify operation. Depending on the status of the M0, M1 and A0 pins, the ADS7861 will (a) operate in either two-channel or four-channel mode and (b) output data on both the Serial A and Serial B output or both channels can be transmitted on the A output only.

NOTE: See the Timing and Control section of this data sheet for more information.

SAMPLE-AND-HOLD SECTION

The sample-and-hold amplifiers on the ADS7861 allow the ADCs to accurately convert an input sine wave of full-scale amplitude to 12-bit accuracy. The input bandwidth of the sample-and-hold is greater than the Nyquist rate (Nyquist equals one-half of the sampling rate) of the ADC even when the ADC is operated at its maximum throughput rate of 500kHz. The typical small-signal bandwidth of the sample-and-hold amplifiers is 40MHz.

Typical aperture delay time or the time it takes for the ADS7861 to switch from the sample to the hold mode following the CONVST pulse is 3.5ns. The average delta of repeated aperture delay values is typically 50ps (also known as aperture jitter). These specifications reflect the ability of the ADS7861 to capture AC input signals accurately at the exact same moment in time.

REFERENCE

Under normal operation, the REF_{OUT} pin (pin 2) should be directly connected to the REF_{IN} pin (pin 1) to provide an internal +2.5V reference to the ADS7862. The ADS7862 can operate, however, with an external reference in the range of 1.2V to 2.6V for a corresponding full-scale range of 2.4V to 5.2V.

The internal reference of the ADS7862 is double-buffered. If the internal reference is used to drive an external load, a buffer is provided between the reference and the load applied to pin 2 (the internal reference can typically source 2mA of current load—capacitance should not exceed 100pF). If an external reference is used, the second buffer provides isolation between the external reference and the CDAC. This buffer is also used to recharge all of the capacitors of both CDACs during conversion.

ANALOG INPUT

The analog input is bipolar and fully differential. There are two general methods of driving the analog input of the ADS7861: single-ended or differential (see Figures 1 and 2). When the input is single-ended, the $-IN$ input is held at the common-mode voltage. The $+IN$ input swings around the same common-mode voltage and the peak-to-peak amplitude is the (common-mode $+V_{REF}$) and the (common-mode $-V_{REF}$). The value of V_{REF} determines the range over which the common-mode voltage may vary (see Figure 3).

When the input is differential, the amplitude of the input is the difference between the $+IN$ and $-IN$ input, or $(+IN) - (-IN)$. The peak-to-peak amplitude of each input is $\pm 1/2V_{REF}$ around this common voltage. However, since the inputs are 180° out of phase, the peak-to-peak amplitude of the differential voltage is $+V_{REF}$ to $-V_{REF}$. The value of V_{REF} also determines the range of the voltage that may be common to both inputs (see Figure 4).

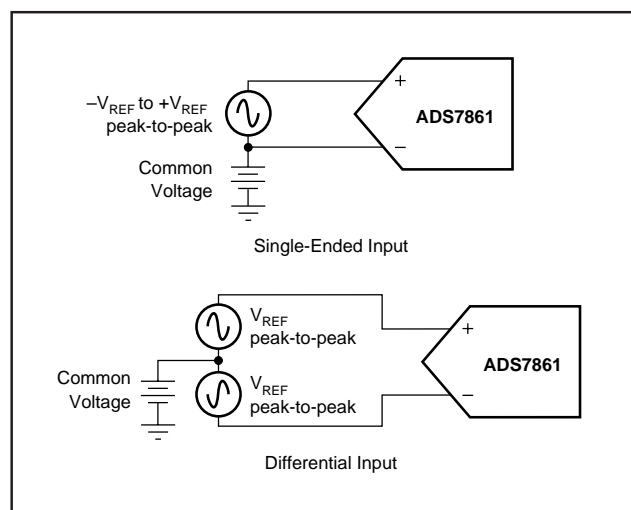

FIGURE 1. Methods of Driving the ADS7861 Single-Ended or Differential.

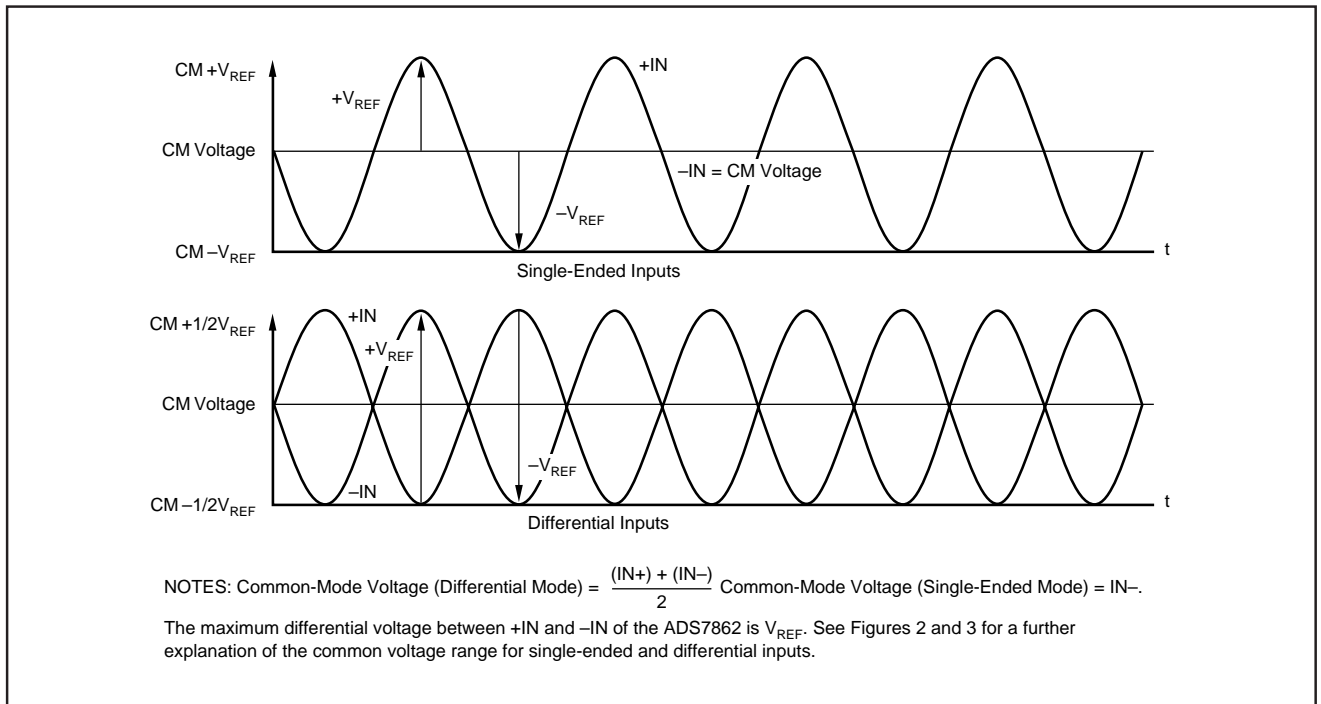

FIGURE 2. Using the ADS7861 in the Single-Ended and Differential Input Modes.

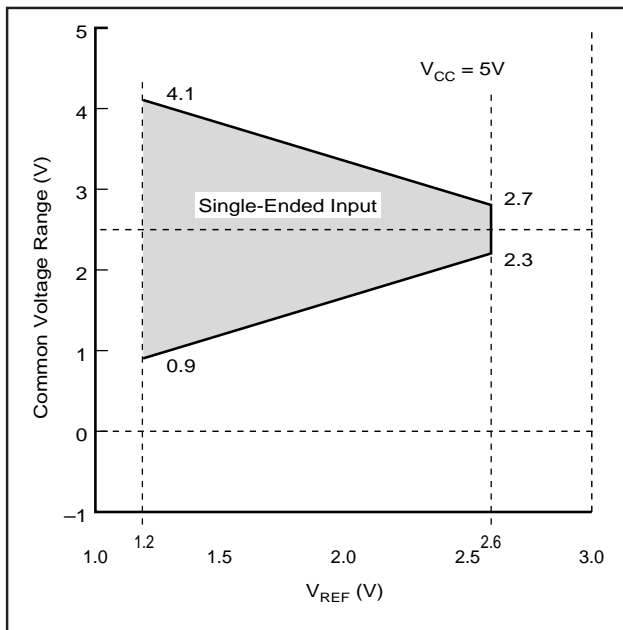

FIGURE 3. Single-Ended Input: Common-Mode Voltage Range vs V_{REF}.

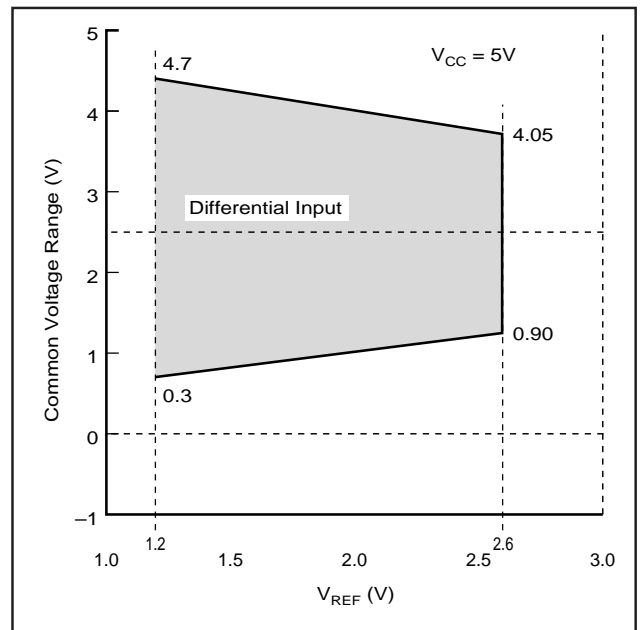

FIGURE 4. Differential Input: Common-Mode Voltage Range vs V_{REF}.

In each case, care should be taken to ensure that the output impedance of the sources driving the +IN and -IN inputs are matched. Otherwise, this may result in offset error, gain error and linearity error which will change with both temperature and input voltage.

The input current on the analog inputs depend on a number of factors: sample rate, input voltage, and source impedance. Essentially, the current into the ADS7861 charges the internal capacitor array during the sampling period. After this

capacitance has been fully charged, there is no further input current. The source of the analog input voltage must be able to charge the input capacitance (15pF) to a 12-bit settling level within 2 clock cycles. When the converter goes into the hold mode, the input impedance is greater than 1GΩ.

Care must be taken regarding the absolute analog input voltage. The +IN input should always remain within the range of GND - 300mV to V_{DD} + 0.3V.

TRANSITION NOISE

Figure 5 shows a histogram plot for the ADS7861 following 8,000 conversions of a DC input. The DC input was set at output code 2046. All but one of the conversions had an output code result of 2046 (one of the conversions resulted in an output of 2047). The histogram reveals the excellent noise performance of the ADS7861.

BIPOLAR INPUTS

The differential inputs of the ADS7861 were designed to accept bipolar inputs ($-V_{REF}$ and $+V_{REF}$) around the internal reference voltage (2.5V), which corresponds to a 0V to 5V input range with a 2.5V reference. By using a simple op amp circuit featuring a single amplifier and four external resistors, the ADS7861 can be configured to accept bipolar inputs. The conventional $\pm 2.5V$, $\pm 5V$, and $\pm 10V$ input ranges can be interfaced to the ADS7861 using the resistor values shown in Figure 7.

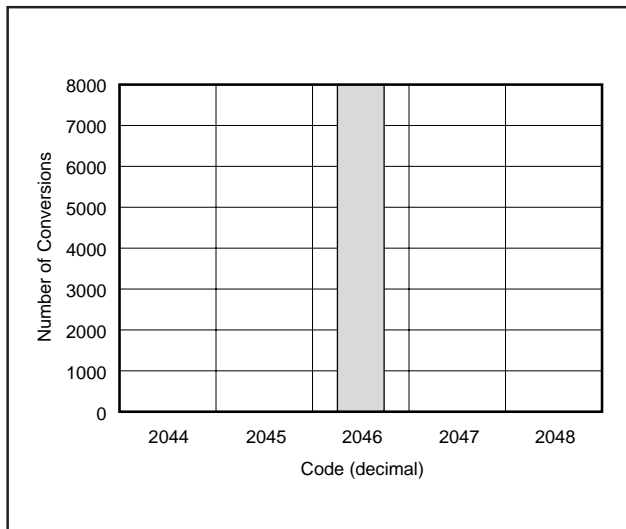

FIGURE 5. Histogram of 8,000 Conversions of a DC Input.

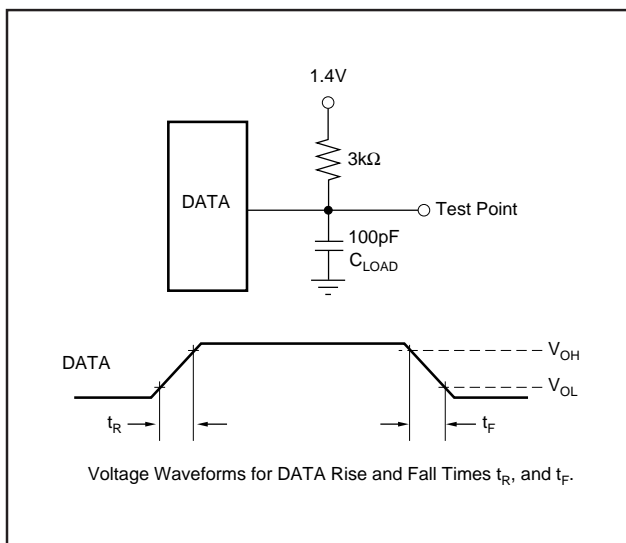

FIGURE 6. Test Circuits for Timing Specifications.

DESCRIPTION	ANALOG INPUT	DIGITAL OUTPUT	
		BINARY TWO'S COMPLEMENT	
Full-Scale Input Span	$-V_{REF}$ to $+V_{REF}^{(1)}$	BINARY CODE	HEX CODE
Least Significant Bit (LSB)	$(-V_{REF}$ to $+V_{REF})/4096^{(2)}$		
+Full Scale	4.99878V	0111 1111 1111	7FF
Midscale	2.5V	0000 0000 0000	000
Midscale - 1 LSB	2.49878V	1111 1111 1111	FFF
-Full Scale	0V	1000 0000 0000	800

NOTES: (1) $-V_{REF}$ to $+V_{REF}$ around V_{REF} . With a 2.5V reference, this corresponds to a 0V to 5V input span. (2) 1.22mV with a 2.5V reference.

TABLE I. Ideal Input Voltages and Output Codes.

TIMING AND CONTROL

The operation of the ADS7861 can be configured in four different modes by using the address pins M0 (pin 14), M1 (pin 15) and A0 (pin 16).

The M0 pin selects between two- and four-channel operation (in two-channel operation, the A0 pin selects between Channels 0 and 1; in four-channel operation the A0 pin is ignored and the channels are switched automatically after each conversion). The M1 pin selects between having serial data transmitted simultaneously on both the Serial A data output (pin 23) and the Serial B data output (pin 22) or having both channels output data through the Serial A port. The A0 pin selects either Channel 0 or Channel 1 (see Pin Descriptions and Serial Output Truth Table for more information).

The next four sections will explain the four different modes of operation.

Mode I (M0 = 0, M1 = 0)

With the M0 and M1 pins both set to '0', the ADS7861 will operate in two-channel operation (the A0 pin must be used to switch between Channels A and B). A conversion is initiated by bringing CONVST HIGH for a minimum of 15ns. It is very important that CONVST be brought HIGH a minimum of 10ns prior to a rising edge of the external clock or 5ns after the rising edge. If CONVST is brought

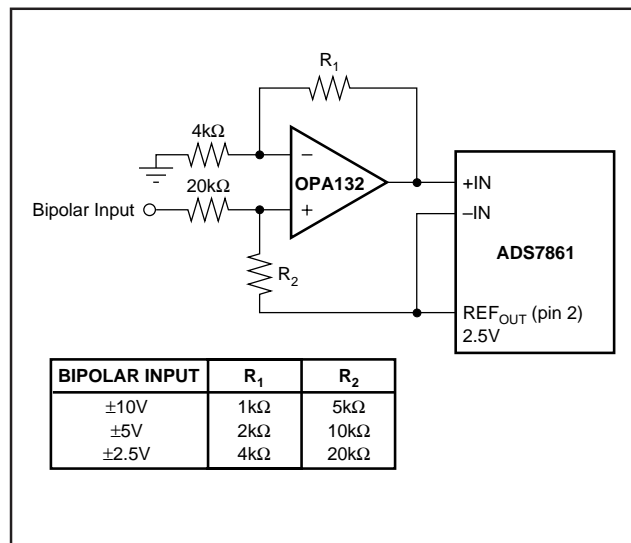

FIGURE 7. Level Shift Circuit for Bipolar Input Ranges.

HIGH within this window, it is then uncertain as to when the ADS7861 will initiate conversion (see Figure 8 for a more detailed description). Sixteen clock cycles are required to perform a single conversion. Immediately following CONVST switching to HIGH, the ADS7861 will switch from the sample mode to the hold mode asynchronous to the external clock. The BUSY output pin will then go HIGH and remain HIGH for the duration of the conversion cycle. On the falling edge of the first cycle of the external clock, the ADS7861 will latch in the address for the next conversion cycle depending on the status of the A0 pin (HIGH =

Channel 1, LOW = Channel 0). The address must be selected 15ns prior to the falling edge of cycle one of the external clock and must remain 'held' for 15ns following the clock edge. For maximum throughput time, the CONVST and RD pins should be tied together. CS must be brought LOW to enable the two serial outputs. Data will be valid on the rising edge of all 16 clock cycles per conversion. The first bit of data will be a status flag for either Channel 0 or 1, the second bit will be a second status flag for either Channel A or B. The subsequent data will be MSB-first through the LSB, followed by two zeros (see Table II and Figures 9 and 10).

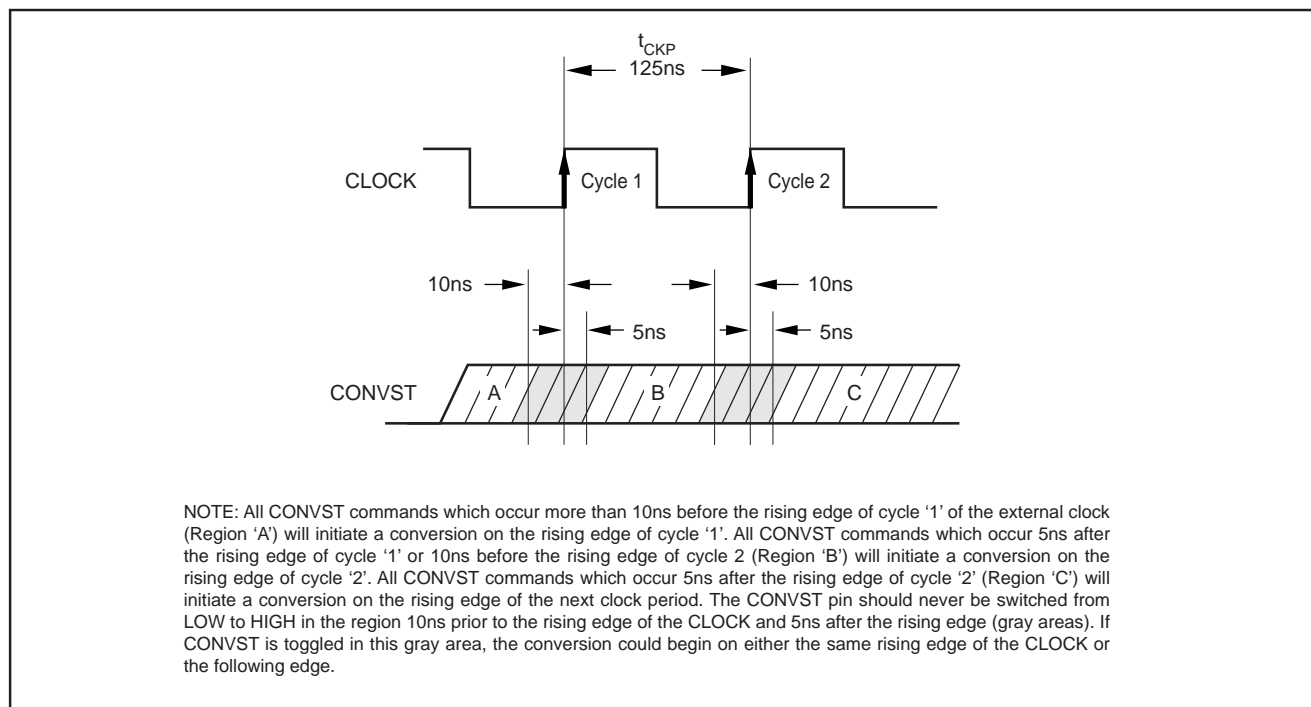

FIGURE 8. Conversion Mode.

TIMING SPECIFICATIONS

SYMBOL	DESCRIPTION	MIN	TYP	MAX	UNITS	COMMENTS
t_{CONV}	Conversion Time	1.75			μ s	When $T_{CKP} = 125$ ns
t_{ACQ}	Acquisition Time	0.25			μ s	When $T_{CKP} = 125$ ns
t_{CKP}	Clock Period	125		5000	ns	
t_{CKL}	Clock LOW	40			ns	
t_{CKH}	Clock HIGH	40			ns	
t_F	DOUT Fall Time			25	ns	
t_R	DOUT Rise Time			30	ns	
t_1	CONVST HIGH	15			ns	
t_2	Address Setup Time	15			ns	Address latched on falling edge of CLK cycle '2'
t_3	Address Hold Time	15			ns	
t_4	RD Setup Time	15			ns	Before falling edge of CLOCK
t_5	RD to CS Hold Time	15			ns	After falling edge of CLOCK
t_6	CONVST LOW	20			ns	
t_7	RD LOW	20			ns	
t_8	CS to Data Valid			25	ns	
t_9	CLOCK to Data Valid Delay			30	ns	Maximum delay following rising edge of CLOCK
t_{10}	Data Valid After CLOCK ⁽¹⁾			1	ns	Time data is valid after second rising edge of CLOCK

NOTE: (1) 'n - 1' data will remain valid 1ns after rising edge of next CLOCK cycle.

CLOCK CYCLE	1	2	3	4	5	6	7	8	9	10	11	12	13	14	15	16
SERIAL DATA	CH0 OR CH1	CHA OR CHB	DB11	DB10	DB9	DB8	DB7	DB6	DB5	DB4	DB3	DB2	DB1	DB0	0	0

TABLE II. Serial Data Output Format.

Mode II (M0 = 0, M1 = 1)

With M1 set to '1', the ADS7861 will output data on the Serial Data A pin only. All other pins function in the same manner as Mode I except that the Serial Data B output will tri-state (i.e., high impedance) after a conversion following M1 going HIGH. Another difference in this mode involves the CONVST pin. Since it takes 32 clock cycles to output the results from both A/D converters (rather than 16 when M1 = 0), the ADS7861 will take 4 μ s to complete a conversion on both A/Ds. Therefore, every second CONVST command will be ignored by the ADS7861 since it will require two conversion cycles to transmit both channels out the serial A port. See Figure 11.

Mode III (M0 = 1, M1 = 0)

With M0 set to '1', the ADS7861 will cycle through Channels 0 and 1 sequentially (the A0 pin is ignored). At the same time, setting M1 to '0' places both Serial Outputs, A and B, in the active mode. See Figure 12.

Mode IV (M0 = 1, M1 = 1)

Similar to Mode II, Mode IV uses the Serial A output line to transmit data exclusively. Following the first conversion after M1 goes HIGH, the serial B output will go into tri-state. See Figure 13. As in Mode II, the second CONVST command is always ignored when M1 = 1.

READING DATA

In all four timing diagrams, the CONVST pin and the RD pins are tied together. If so desired, the two lines can be separated. Data on the Serial Output pins (A and B) will become valid following the third external clock cycle following a RD LOW. Refer to Table II for data output format.

LAYOUT

For optimum performance, care should be taken with the physical layout of the ADS7861 circuitry. This is particularly true if the CLOCK input is approaching the maximum throughput rate.

The basic SAR architecture is sensitive to glitches or sudden changes on the power supply, reference, ground connections and digital inputs that occur just prior to latching the output

of the analog comparator. Thus, driving any single conversion for an n-bit SAR converter, there are n "windows" in which large external transient voltages can affect the conversion result. Such glitches might originate from switching power supplies, nearby digital logic or high power devices. The degree of error in the digital output depends on the reference voltage, layout, and the exact timing of the external event. Their error can change if the external event changes in time with respect to the CLOCK input.

With this in mind, power to the ADS7861 should be clean and well bypassed. A 0.1 μ F ceramic bypass capacitor should be placed as close to the device as possible. In addition, a 1 μ F to 10 μ F capacitor is recommended. If needed, an even larger capacitor and a 5 Ω or 10 Ω series resistor may be used to low pass filter a noisy supply. On average, the ADS7861 draws very little current from an external reference as the reference voltage is internally buffered. However, glitches from the conversion process appear at the V_{REF} input and the reference source must be able to handle this. Whether the reference is internal or external, the V_{REF} pin should be bypassed with a 0.1 μ F capacitor. An additional larger capacitor may also be used, if desired. If the reference voltage is external and originates from an op amp, make sure that it can drive the bypass capacitor or capacitors without oscillation. No bypass capacitor is necessary when using the internal reference (tie pin 10 directly to pin 11).

The GND pin should be connected to a clean ground point. In many cases, this will be the 'analog' ground. Avoid connections which are too near the grounding point of a microcontroller or digital signal processor. If required, run a ground trace directly from the converter to the power supply entry point. The ideal layout will include an analog ground plane dedicated to the converter and associated analog circuitry.

APPLICATIONS

An applications section will be added featuring the ADS7862 interfacing to popular DSP processors. The updated data sheet will be available in the near future on the Burr-Brown web site:

<http://www.burr-brown.com/>

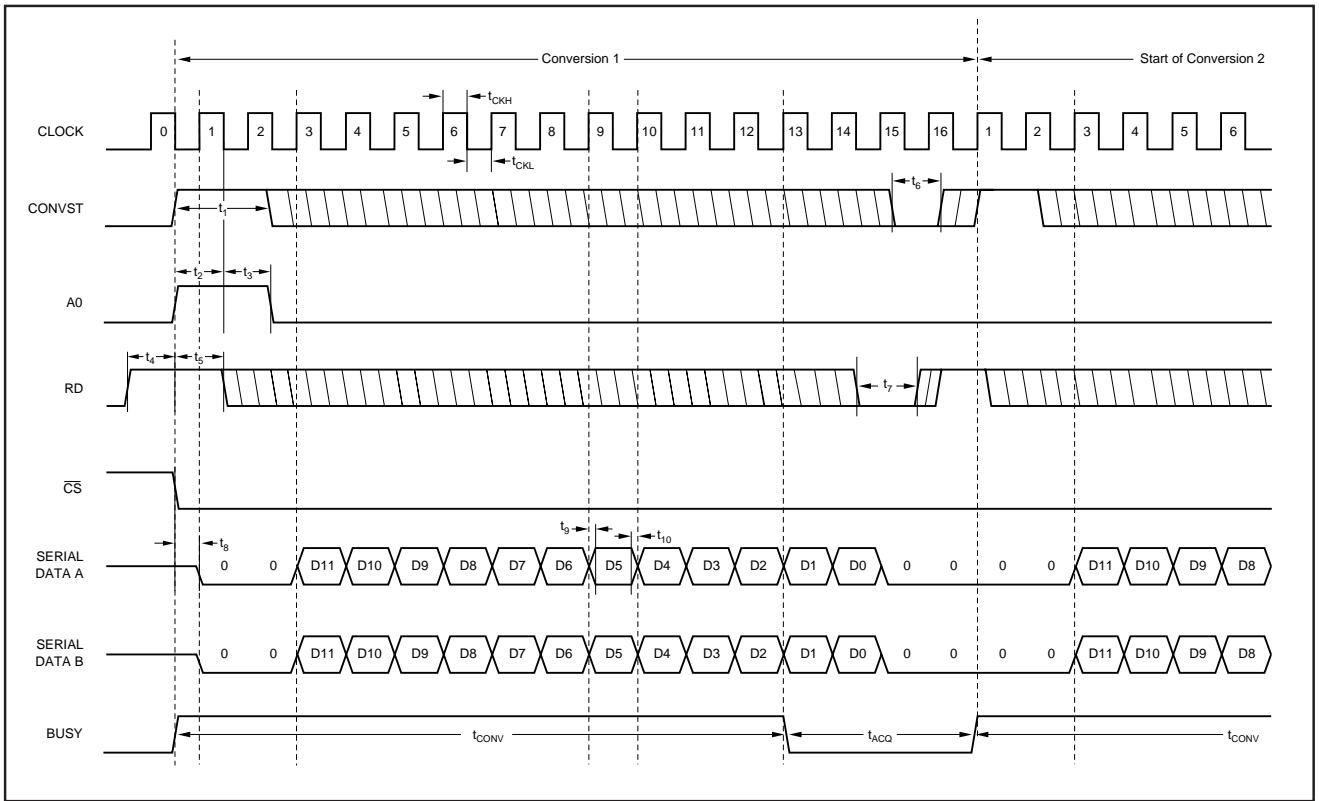

FIGURE 9. Mode I with Timing Specifications.

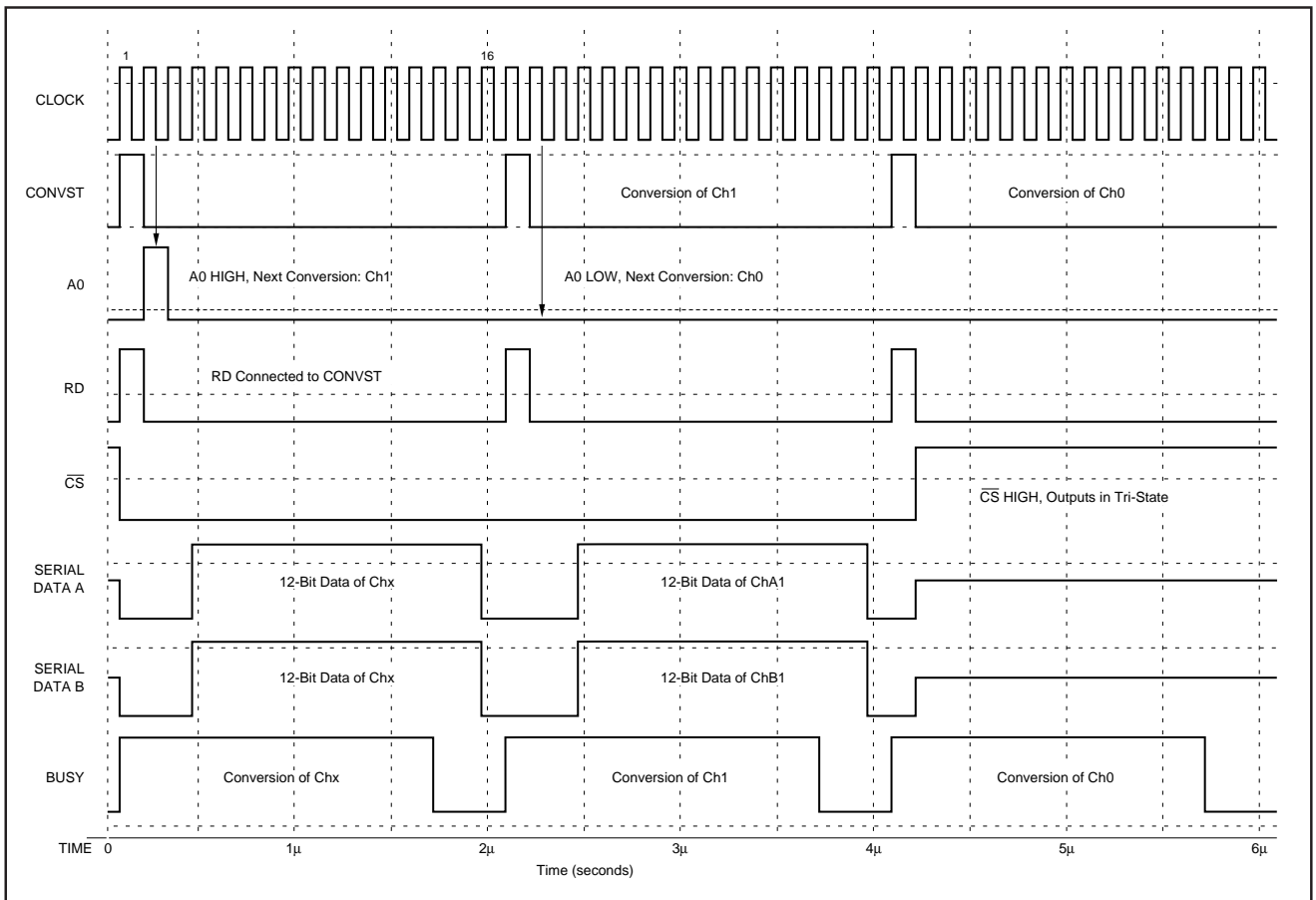

FIGURE 10. Mode I, Timing Diagram for M0 = 0 and M1 = 0.

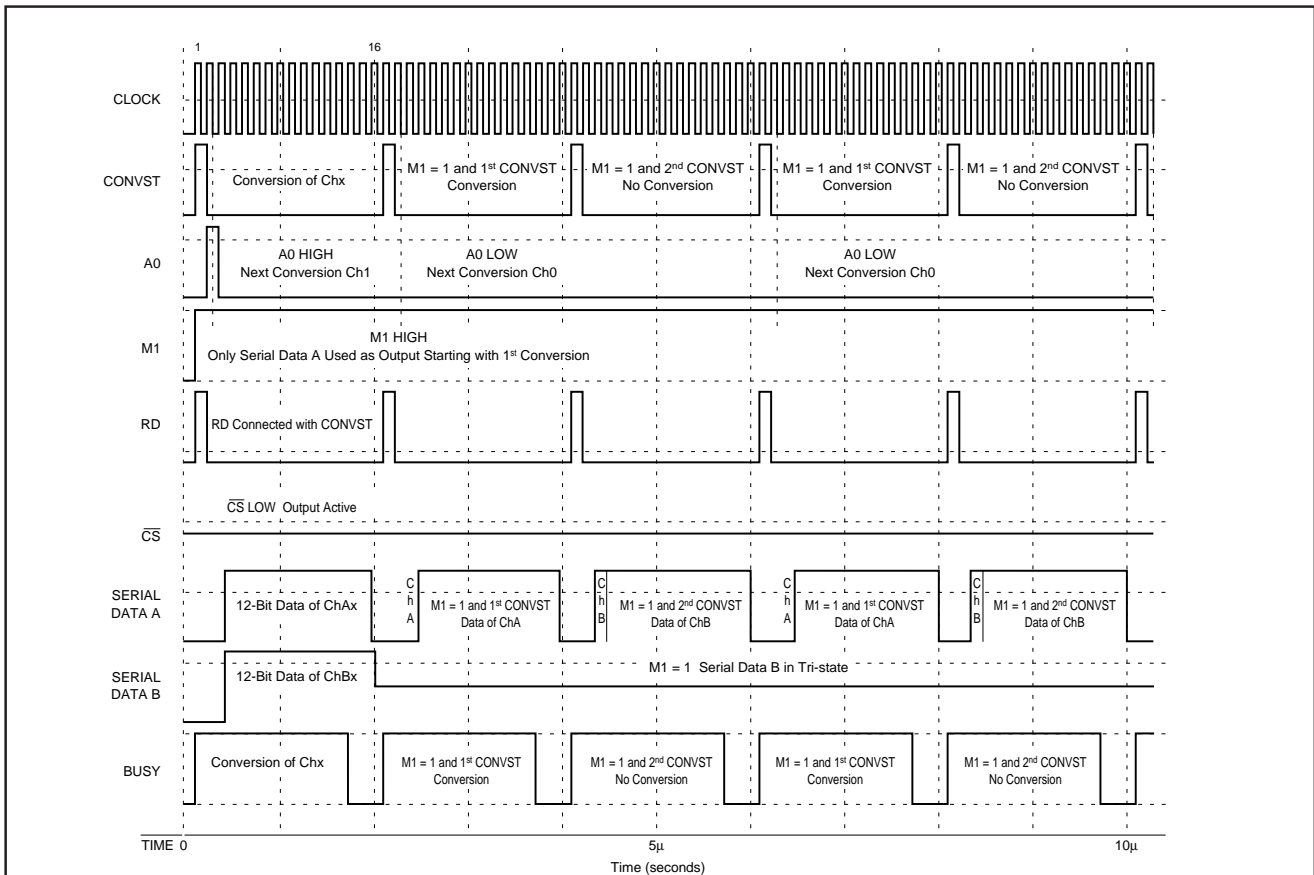

FIGURE 11. Mode II, Timing Diagram for M0 = 0 and M1 = 1.

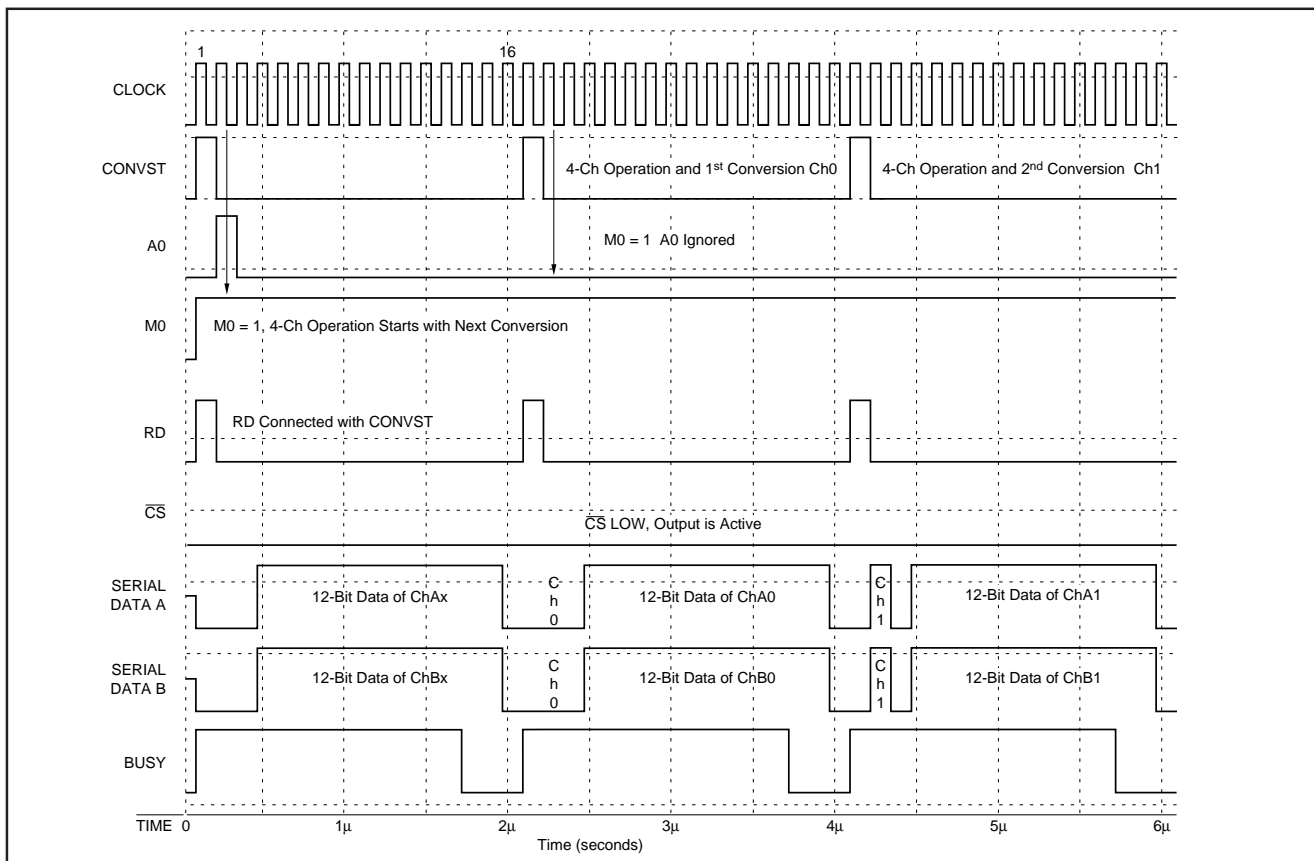

FIGURE 12. Mode III, Timing Diagram for M0 = 1 and M1 = 0.

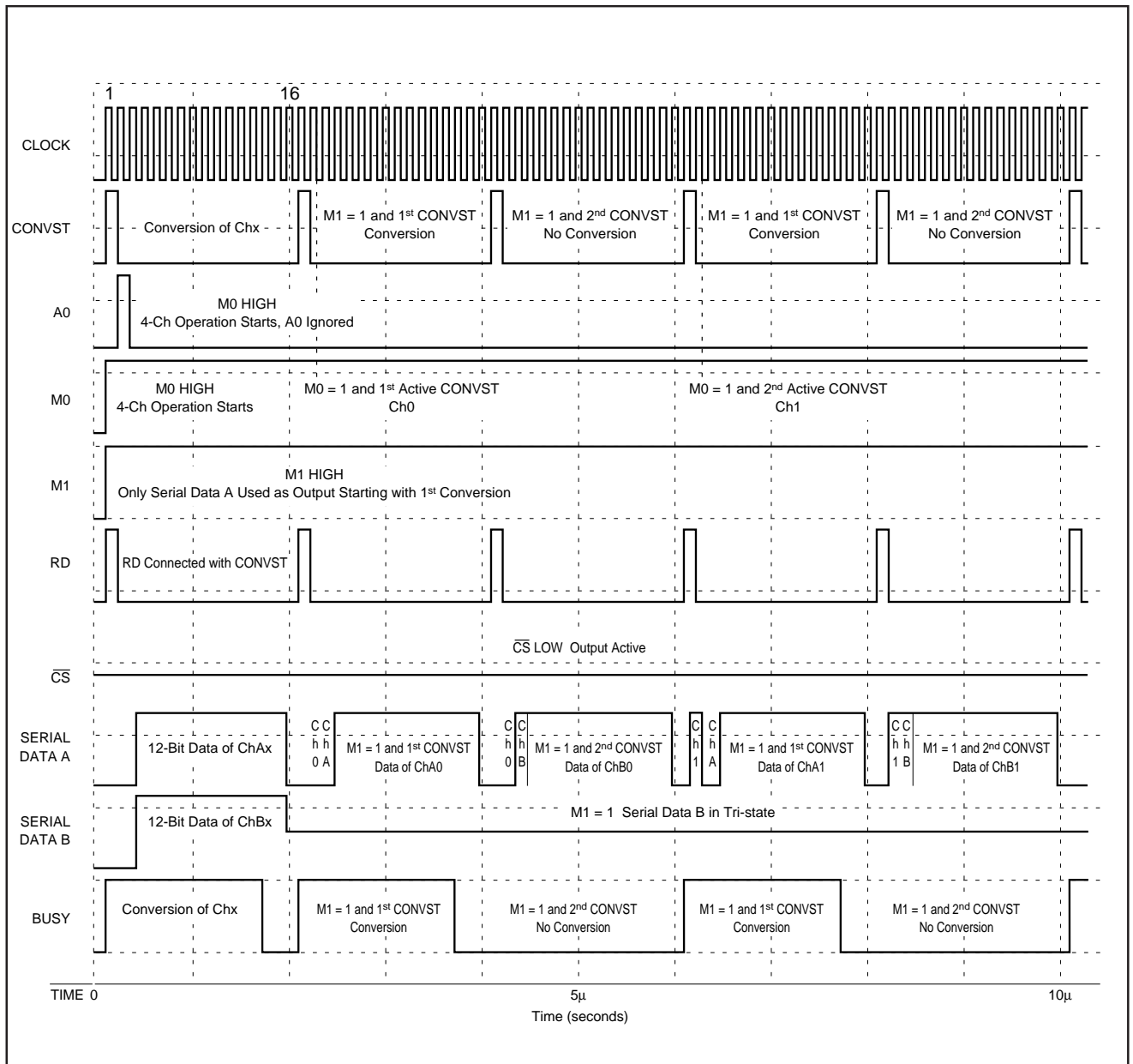

FIGURE 13. Mode IV, Timing Diagram for $M0 = 1$ and $M1 = 1$.