

INA2128

Dual, Low Power INSTRUMENTATION AMPLIFIER

FEATURES

- **LOW OFFSET VOLTAGE:** 50μV max
- **LOW DRIFT:** 0.5μV/°C max
- **LOW INPUT BIAS CURRENT:** 5nA max
- **HIGH CMR:** 120dB min
- **INPUTS PROTECTED TO ±40V**
- **WIDE SUPPLY RANGE:** ±2.25V to ±18V
- **LOW QUIESCENT CURRENT:** 700μA / IA
- **16-PIN PLASTIC DIP, SOL-16**

APPLICATIONS

- **SENSOR AMPLIFIER**
THERMOCOUPLE, RTD, BRIDGE
- **MEDICAL INSTRUMENTATION**
- **MULTIPLE-CHANNEL SYSTEMS**
- **BATTERY OPERATED EQUIPMENT**

DESCRIPTION

The INA2128 is a dual, low power, general purpose instrumentation amplifier offering excellent accuracy. Its versatile 3-op amp design and small size make it ideal for a wide range of applications. Current-feedback input circuitry provides wide bandwidth even at high gain (200kHz at $G = 100$).

A single external resistor sets any gain from 1 to 10,000. Internal input protection can withstand up to ±40V without damage.

The INA2128 is laser trimmed for very low offset voltage (50μV), drift (0.5μV/°C) and high common-mode rejection (120dB at $G \geq 100$). It operates with power supplies as low as ±2.25V, and quiescent current is only 700μA per IA—ideal for battery operated and multiple-channel systems.

The INA2128 is available in 16-pin plastic DIP, and SOL-16 surface-mount packages, specified for the -40°C to +85°C temperature range.

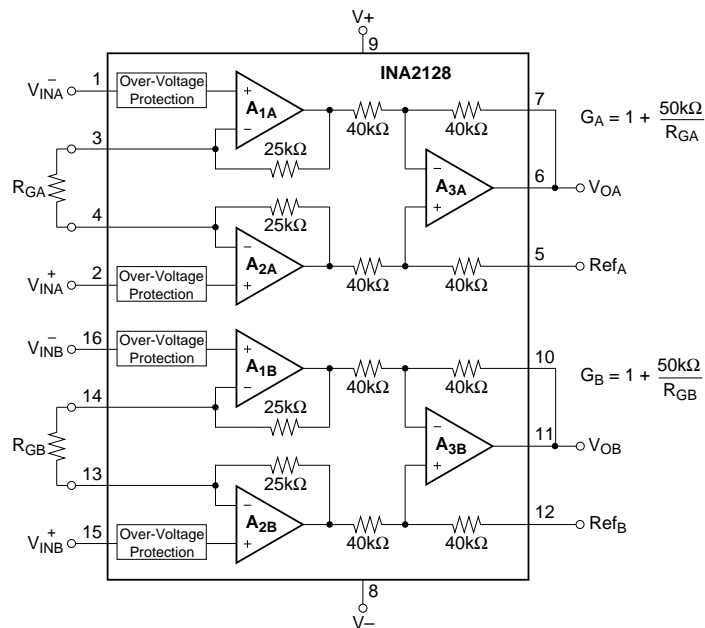

International Airport Industrial Park • Mailing Address: PO Box 11400, Tucson, AZ 85734 • Street Address: 6730 S. Tucson Blvd., Tucson, AZ 85706 • Tel: (520) 746-1111 • Twx: 910-952-1111
Internet: <http://www.burr-brown.com/> • FAXLine: (800) 548-6133 (US/Canada Only) • Cable: BBRCORP • Telex: 066-6491 • FAX: (520) 889-1510 • Immediate Product Info: (800) 548-6132

PIN CONFIGURATION

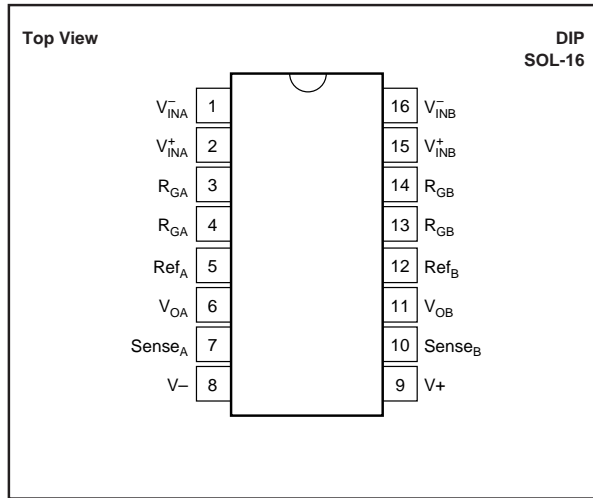

ABSOLUTE MAXIMUM RATINGS

Supply Voltage	$\pm 18V$
Analog Input Voltage Range	$\pm 40V$
Output Short-Circuit (to ground)	Continuous
Operating Temperature	$-40^{\circ}C$ to $+125^{\circ}C$
Storage Temperature	$-40^{\circ}C$ to $+125^{\circ}C$
Junction Temperature	$+150^{\circ}C$
Lead Temperature (soldering, 10s)	$+300^{\circ}C$



ELECTROSTATIC DISCHARGE SENSITIVITY

This integrated circuit can be damaged by ESD. Burr-Brown recommends that all integrated circuits be handled with appropriate precautions. Failure to observe proper handling and installation procedures can cause damage.

ESD damage can range from subtle performance degradation to complete device failure. Precision integrated circuits may be more susceptible to damage because very small parametric changes could cause the device not to meet its published specifications.

ORDERING INFORMATION

PRODUCT	PACKAGE	PACKAGE DRAWING NUMBER ⁽¹⁾	TEMPERATURE RANGE
INA2128PA	16-Pin Plastic DIP	180	$-40^{\circ}C$ to $+85^{\circ}C$
INA2128P	16-Pin Plastic DIP	180	$-40^{\circ}C$ to $+85^{\circ}C$
INA2128UA	SOL-16 Surface-Mount	211	$-40^{\circ}C$ to $+85^{\circ}C$
INA2128U	SOL-16 Surface-Mount	211	$-40^{\circ}C$ to $+85^{\circ}C$

NOTE: (1) For detailed drawing and dimension table, please see end of data sheet, or Appendix C of Burr-Brown IC Data Book.

TYPICAL PERFORMANCE CURVES

At $T_A = +25^\circ\text{C}$, $V_S = \pm 15\text{V}$, unless otherwise noted.

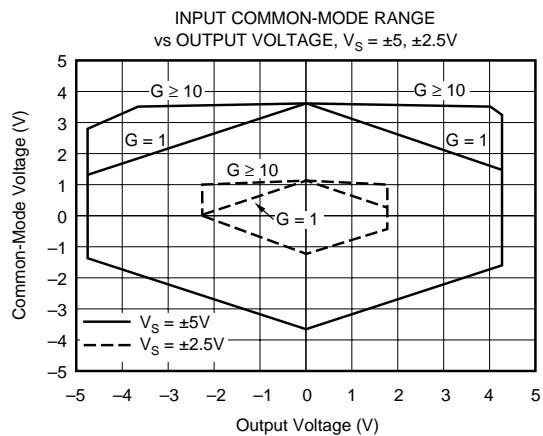
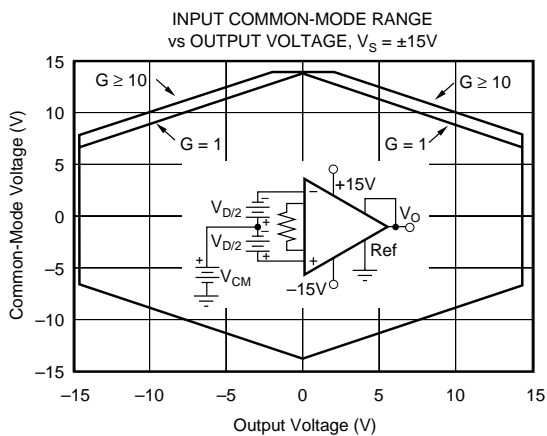
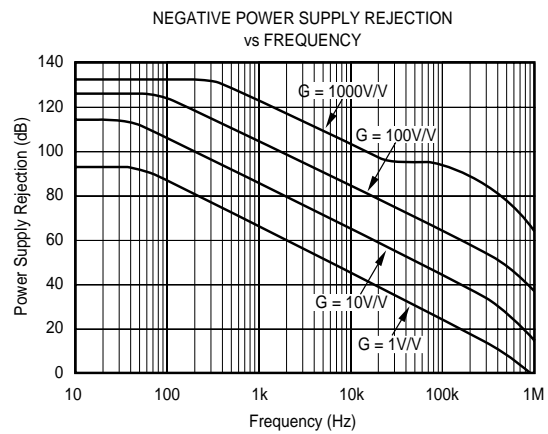
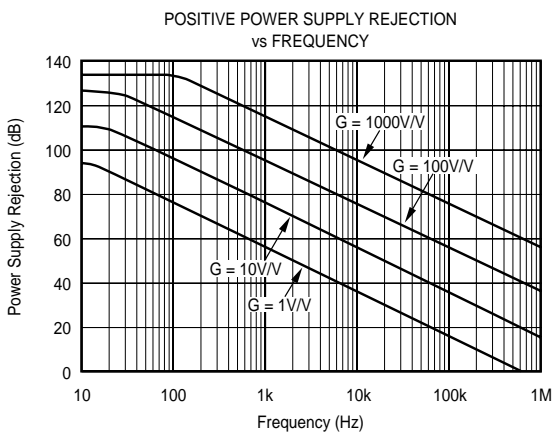
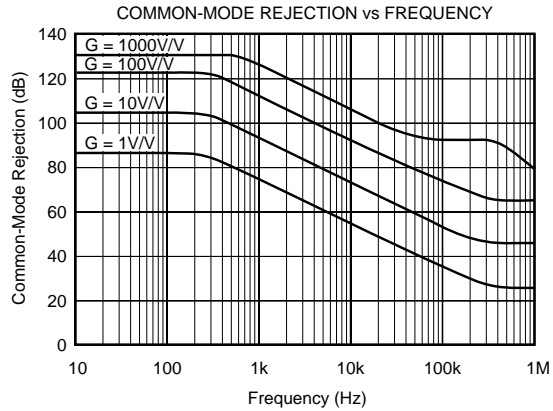
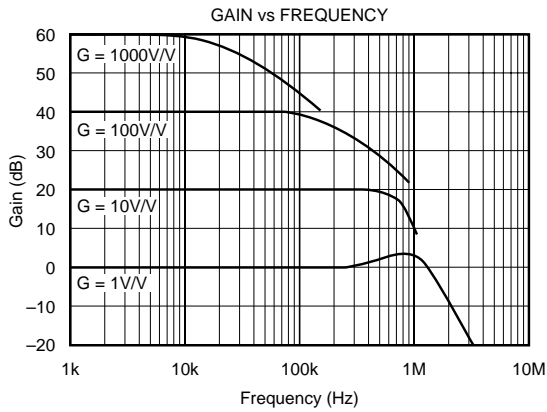

TYPICAL PERFORMANCE CURVES (CONT)

At $T_A = +25^\circ\text{C}$, $V_S = \pm 15\text{V}$, unless otherwise noted.

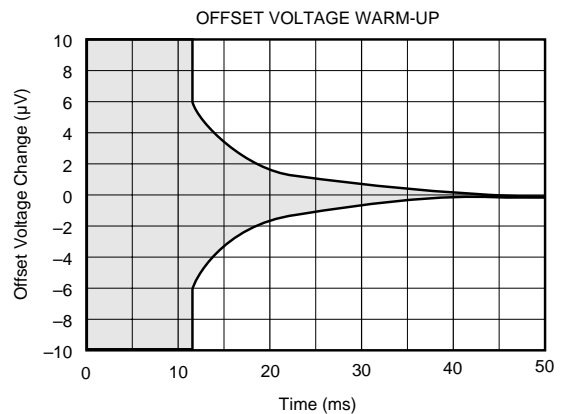
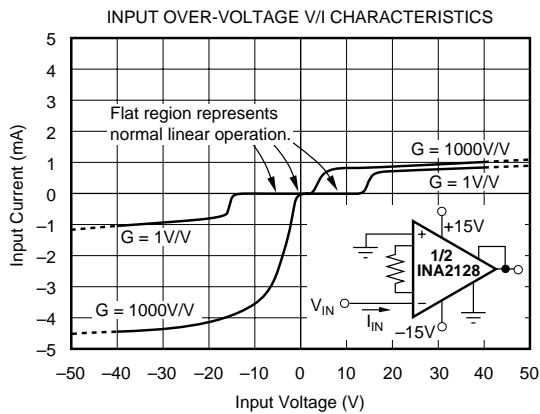
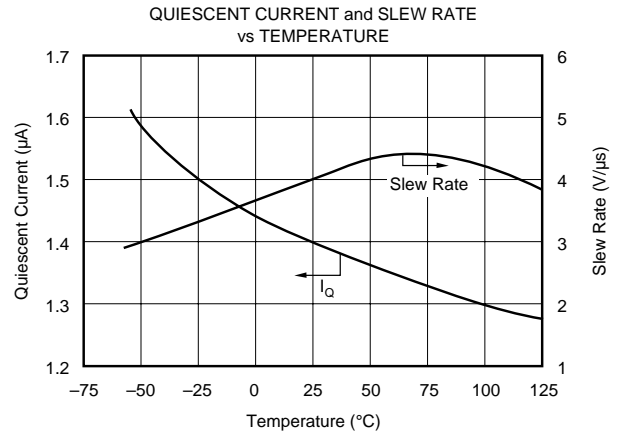
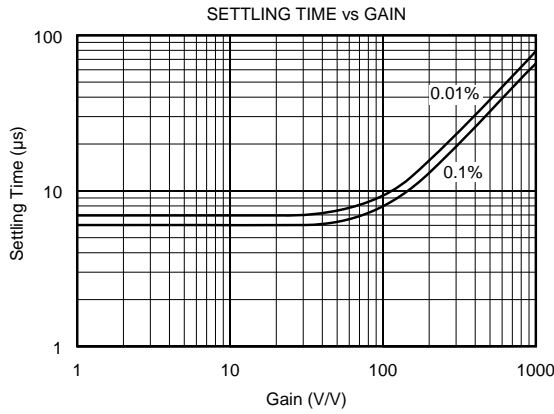
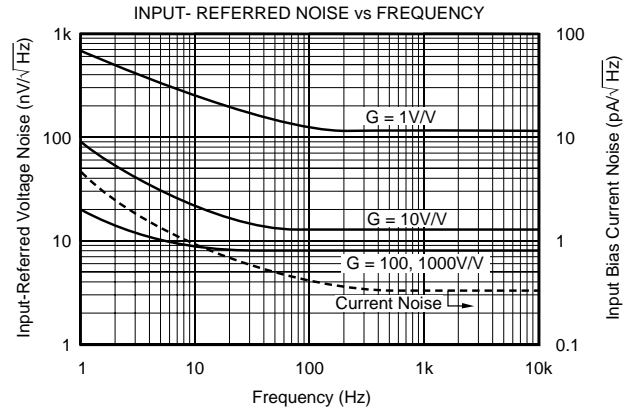
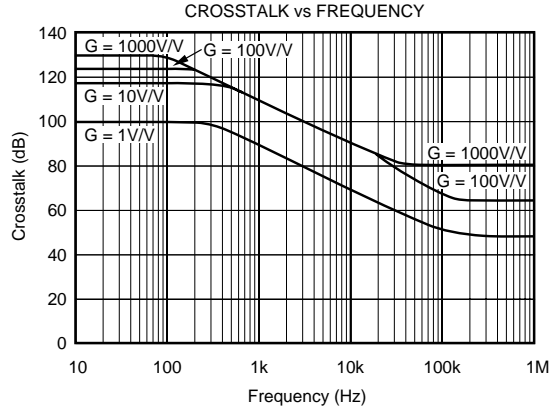

TYPICAL PERFORMANCE CURVES (CONT)

At $T_A = +25^\circ\text{C}$, $V_S = \pm 15\text{V}$, unless otherwise noted.

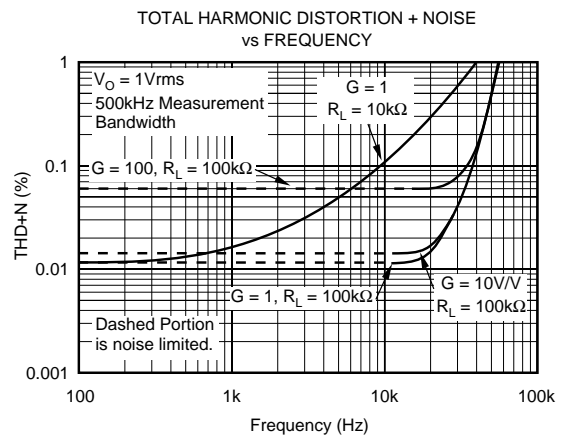
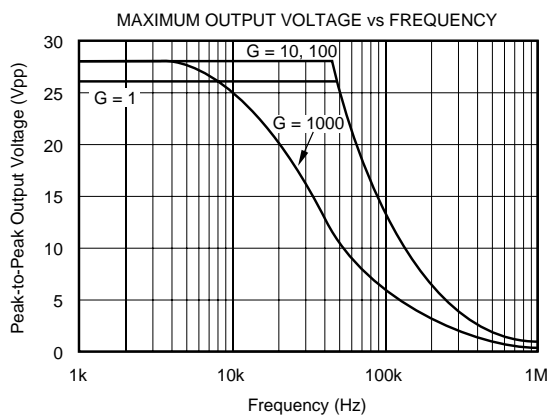
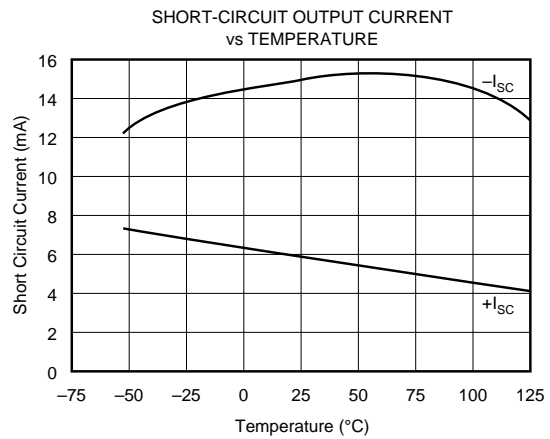
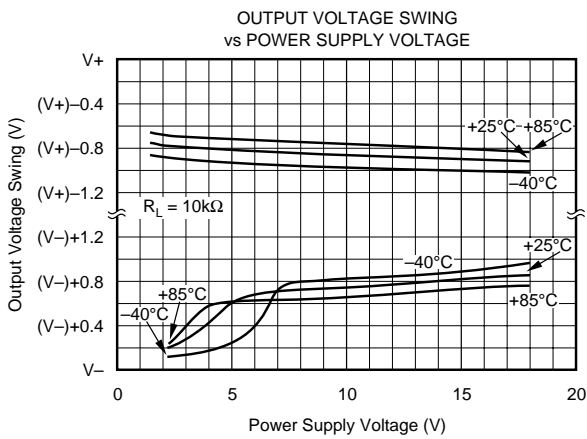
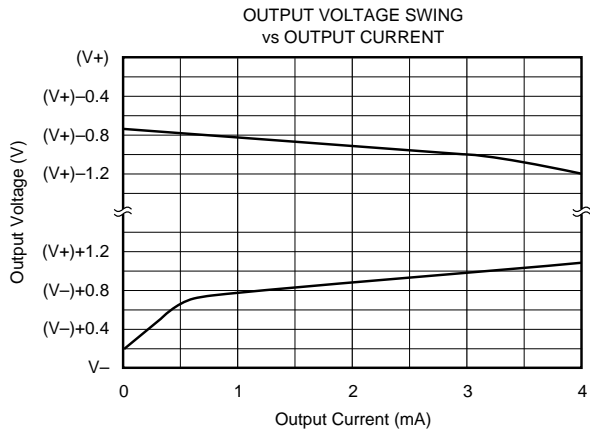
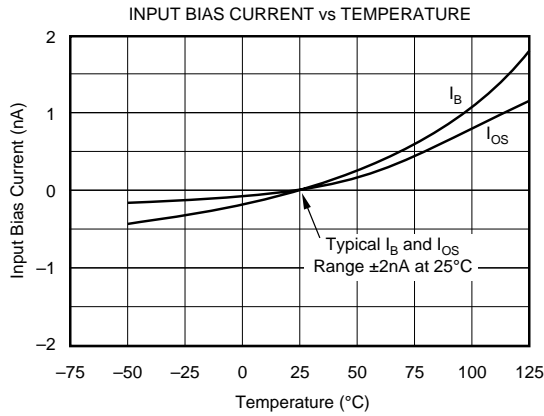

TYPICAL PERFORMANCE CURVES (CONT)

At $T_A = +25^\circ\text{C}$, $V_S = \pm 15\text{V}$, unless otherwise noted.

SMALL-SIGNAL STEP RESPONSE
(G = 1, 10)

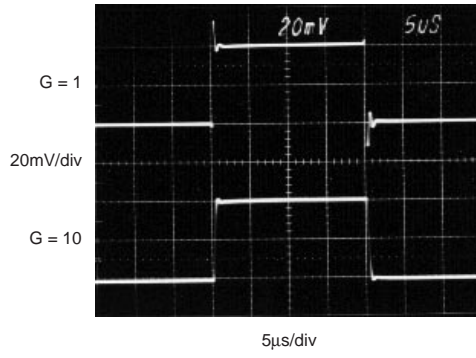

SMALL-SIGNAL STEP RESPONSE
(G = 100, 1000)

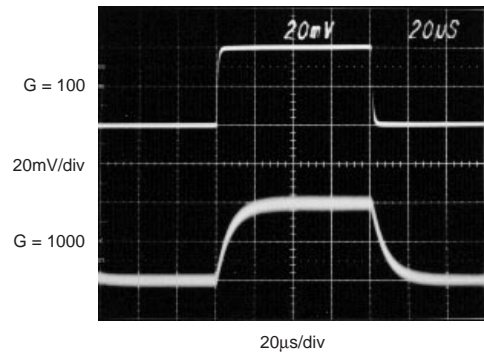

LARGE-SIGNAL STEP RESPONSE
(G = 1, 10)

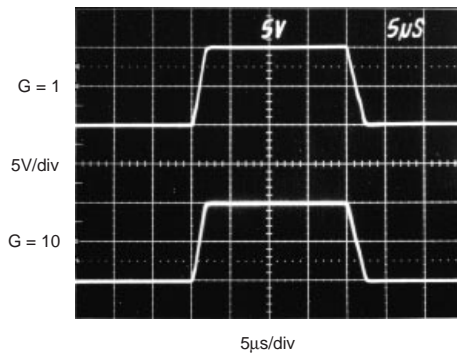

LARGE-SIGNAL STEP RESPONSE
(G = 100, 1000)

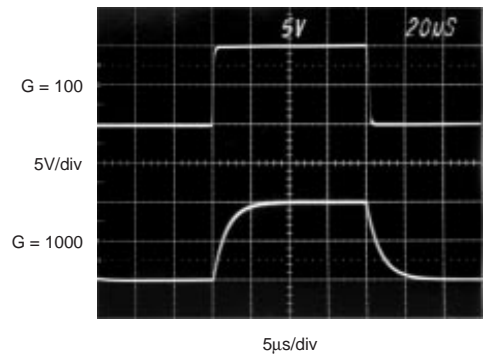

VOLTAGE NOISE 0.1 to 10Hz
INPUT-REFERRED, $G \geq 100$

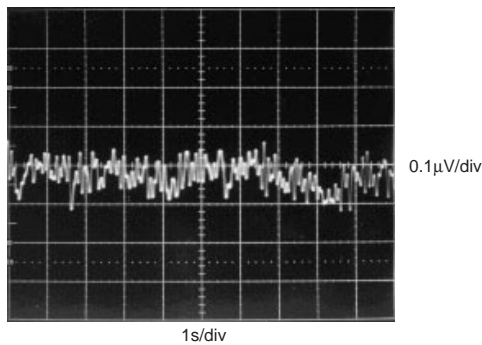

APPLICATION INFORMATION

Figure 1 shows the basic connections required for operation of the INA2128. Applications with noisy or high impedance power supplies may require decoupling capacitors close to the device pins as shown.

The output is referred to the output reference (Ref) terminals (Ref_A and Ref_B) which are normally grounded. These must be low-impedance connections to assure good common-mode rejection. A resistance of 8Ω in series with a Ref pin will cause a typical device to degrade to approximately 80dB CMR (G = 1).

The INA2128 has a separate output sense feedback connections Sense_A and Sense_B. These must be connected to their respective output terminals for proper operation. The output sense connection can be used to sense the output voltage directly at the load for best accuracy.

SETTING THE GAIN

Gain of the INA2128 is set by connecting a single external resistor, R_G, connected as shown:

$$G = 1 + \frac{50k\Omega}{R_G} \tag{1}$$

Commonly used gains and resistor values are shown in Figure 1.

The 50kΩ term in equation 1 comes from the sum of the two

internal feedback resistors of A₁ and A₂. These on-chip metal film resistors are laser trimmed to accurate absolute values. The accuracy and temperature coefficient of these resistors are included in the gain accuracy and drift specifications of the INA2128.

The stability and temperature drift of the external gain setting resistor, R_G, also affects gain. R_G's contribution to gain accuracy and drift can be directly inferred from the gain equation (1). Low resistor values required for high gain can make wiring resistance important. Sockets add to the wiring resistance which will contribute additional gain error in gains of approximately 100 or greater.

DYNAMIC PERFORMANCE

The typical performance curve “Gain vs Frequency” shows that despite its low quiescent current, the INA2128 achieves wide bandwidth, even at high gain. This is due to its current-feedback topology. Settling time also remains excellent at high gain—see “Settling Time vs Gain.”

NOISE PERFORMANCE

The INA2128 provides very low noise in most applications. Low frequency noise is approximately 0.2μVp-p measured from 0.1 to 10Hz (G ≥ 100). This provides dramatically improved noise when compared to state-of-the-art chopper-stabilized amplifiers.

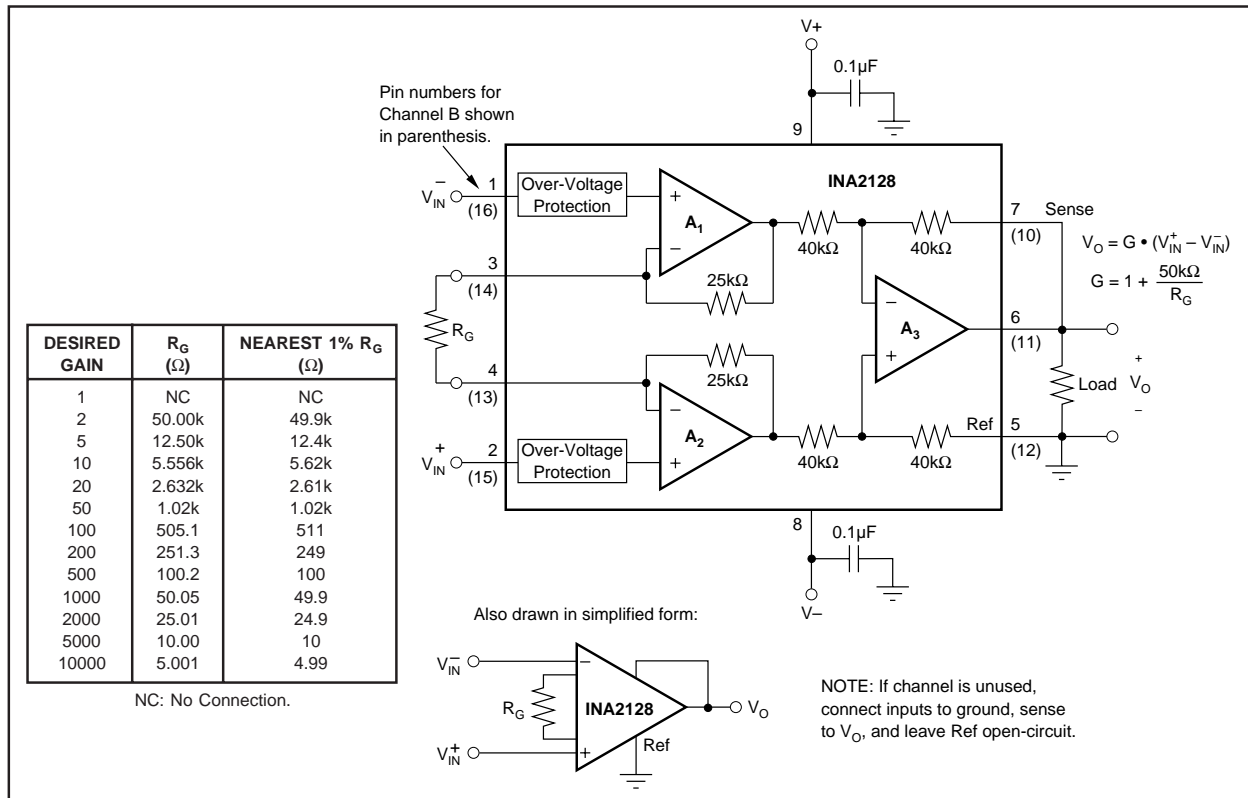

FIGURE 1. Basic Connections.

OFFSET TRIMMING

The INA2128 is laser trimmed for low offset voltage and offset voltage drift. Most applications require no external offset adjustment. Figure 2 shows an optional circuit for trimming the output offset voltage. The voltage applied to Ref terminal is summed with the output. The op amp buffer provides low impedance at the Ref terminal to preserve good common-mode rejection.

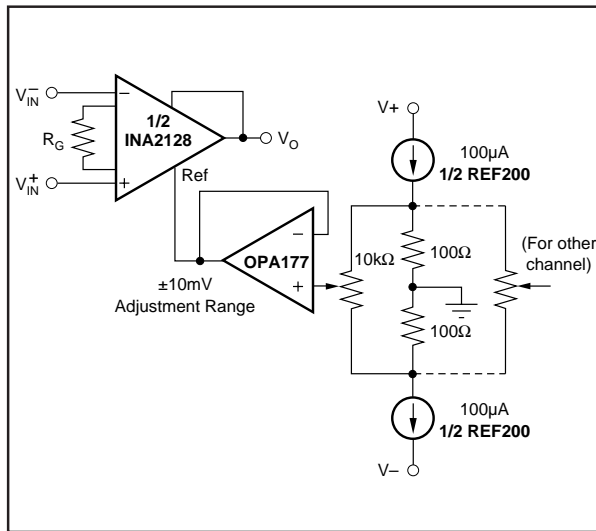

FIGURE 2. Optional Trimming of Output Offset Voltage.

INPUT BIAS CURRENT RETURN PATH

The input impedance of the INA2128 is extremely high—approximately $10^{10}\Omega$. However, a path must be provided for the input bias current of both inputs. This input bias current is approximately $\pm 2\text{nA}$. High input impedance means that this input bias current changes very little with varying input voltage.

Input circuitry must provide a path for this input bias current for proper operation. Figure 3 shows various provisions for an input bias current path. Without a bias current path, the inputs will float to a potential which exceeds the common-mode range of the INA2128 and the input amplifiers will saturate.

If the differential source resistance is low, the bias current return path can be connected to one input (see the thermocouple example in Figure 3). With higher source impedance, using two equal resistors provides a balanced input with possible advantages of lower input offset voltage due to bias current and better high-frequency common-mode rejection.

INPUT COMMON-MODE RANGE

The linear input voltage range of the input circuitry of the INA2128 is from approximately 1.4V below the positive supply voltage to 1.7V above the negative supply. As a differential input voltage causes the output voltage increase, however, the linear input range will be limited by the output

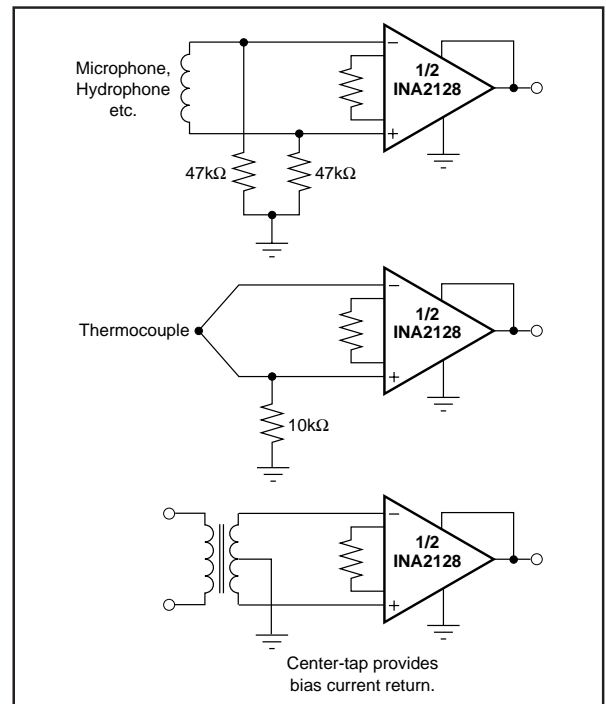

FIGURE 3. Providing an Input Common-Mode Current Path.

voltage swing of amplifiers A_1 and A_2 . So the linear common-mode input range is related to the output voltage of the complete amplifier. This behavior also depends on supply voltage—see performance curves “Input Common-Mode Range vs Output Voltage.”

Input-overload can produce an output voltage that appears normal. For example, if an input overload condition drives both input amplifiers to their positive output swing limit, the difference voltage measured by the output amplifier will be near zero. The output of the INA2128 will be near 0V even though both inputs are overloaded.

LOW VOLTAGE OPERATION

The INA2128 can be operated on power supplies as low as $\pm 2.25\text{V}$. Performance remains excellent with power supplies ranging from $\pm 2.25\text{V}$ to $\pm 18\text{V}$. Most parameters vary only slightly throughout this supply voltage range—see typical performance curves. Operation at very low supply voltage requires careful attention to assure that the input voltages remain within their linear range. Voltage swing requirements of internal nodes limit the input common-mode range with low power supply voltage. Typical performance curves, “Input Common-Mode Range vs Output Voltage” show the range of linear operation for $\pm 15\text{V}$, $\pm 5\text{V}$, and $\pm 2.5\text{V}$ supplies.

