

FEATURES

- Rise/Fall Time..... **4.0ns**
- Swing **65VP-P**
- Emitter Peaking Option
- Supply Voltage..... **90V**
- Excellent Gray Scale Linearity
- Consistent EMI Performance

APPLICATIONS

- CRT driver for up to 69kHz monitors with resolution up to 1280 x 1024.
- Excellent Gray Scale Linearity

DESCRIPTION

The CVA3404T contains three high impedance wideband amplifiers, designed specifically to drive a CRT. It features no crossover distortion for excellent gray scale linearity. This device can drive monitors with resolutions of 1280 x 1024 (non-interlaced) with pixel frequency of 160MHz.

The part is housed in the industry standard 11-lead TO-220 molded power package. The heat sink is grounded.

ORDERING INFORMATION

Part	Package	Temperature
CVA3404T	T11A	-20°C to +100°C

CONNECTION DIAGRAM AND SIMPLIFIED SCHEMATIC

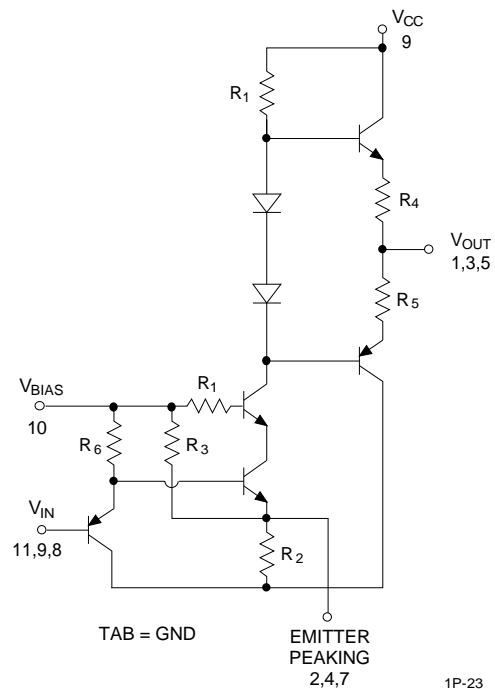
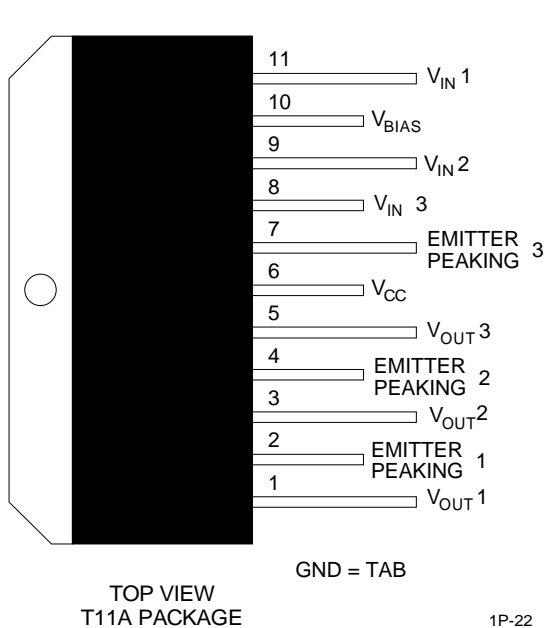

ABSOLUTE MAXIMUM RATINGS

Supply Voltage	90V	ESD	2000V
Power Dissipation	14W	Operating Temperature	-20°C to +100°C
Storage Temperature	-50°C to +150°C	Lead Temperature	+300°C

DC ELECTRICAL CHARACTERISTICS $V_s = 80V$, $C_L = 8pF$, $DC_{INPUT\ BIAS} = 12V$, $V_{IN} = 2.2V$, $V_{OUT} = 50V_{p-p}$. $T_{CASE} = +25^\circ C$. See Figure 1.

SYMBOL	CHARACTERISTICS	MIN	TYP	MAX	UNITS
I_{CC}	Supply Current, Per Channel		20	26	mA
I_B	Bias Current		40		mA
$V_{OUT\ DC}$	Output DC Level	47	50	53	V
A_v	Voltage Gain	-11	-13	-15	V
	Gain Matching		0.5		dB

AC ELECTRICAL CHARACTERISTICS $V_s = 80V$, $C_L = 8pF$, $DC_{INPUT\ BIAS} = 12V$, $V_{IN} = 2.2V$, $V_{OUT} = 40V_{p-p}$. $T_{CASE} = +25^\circ C$. See Figure 1.

SYMBOL	CHARACTERISTICS	MIN	TYP	MAX	UNITS
T_r	Rise Time		6		ns
T_f	Fall Time		6		ns
L_e	Linearity		5		%

FIGURE 1. TEST CIRCUIT

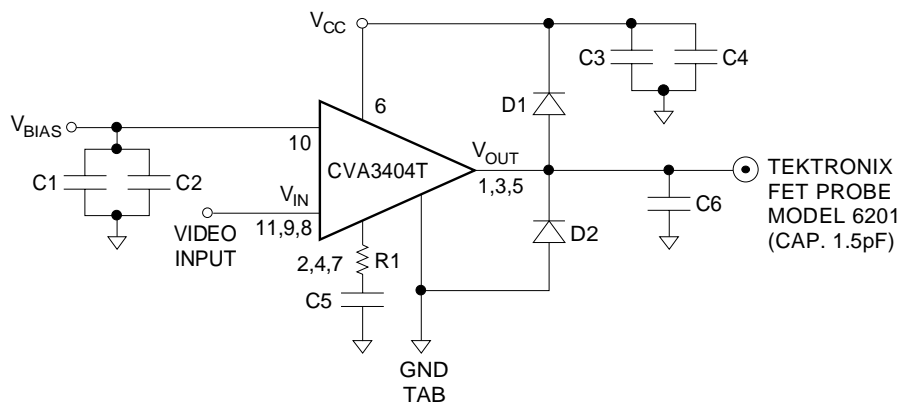

- | | | | |
|-------------------|--------------------|-------------------|-------------------|
| $R1 = 47\ \Omega$ | $C1 = 0.01\ \mu F$ | $C4 = 100\ \mu F$ | $D1, D2 = FHD400$ |
| | $C2 = 100\ \mu F$ | $C5 = 27\ pF$ | |
| | $C3 = 0.1\ \mu F$ | $C6 = 8\ pF$ | |

FIGURE 2.

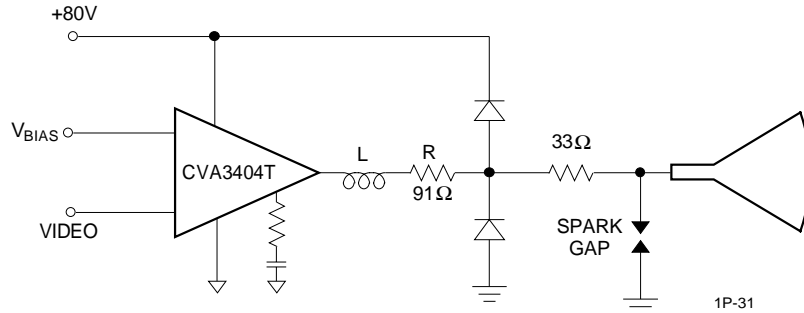
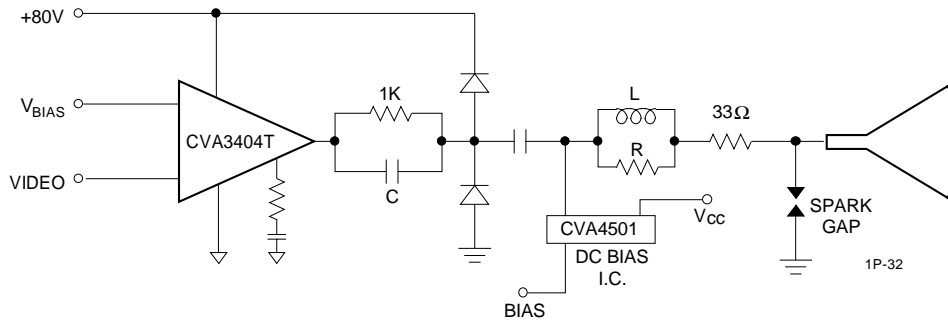

FIGURE 3.



APPLICATION INFORMATION

The CVA3404T is a high voltage triple CRT driver suitable to drive 69kHz, 1280 x 1024 CRT displays. It features a high impedance input to match any pre-amplifier. The CVA3404T has a true class AB output stage that results in excellent gray scale linearity and consistent EMI performance.

As with any high speed amplifier used in CRT display applications, specific precaution should be taken to get the required performance. Power supply should be by pass as close to the device pin as possible. Use 0.01μf very near to the device and a large capacitor of 10μf or more (preferable 100μf) near the device. A 0.1μf and 10μf should be connected near the V_{bias} pin (#10). Arc protection is very essential. Fast diodes together with the spark gap will achieve sufficient protection. However, in certain applications depends on the tubes a high value of resistor is required to reduce the current into the CVA3404T during arcing. This will result in less than desirable performance some of which can be restored by using a peaking inductor at the output pin, *Figure 2*. Another way to achieve this is by using a RC network at the output of the device and use a peaking inductor at the tube, *Figure 3*.

The rise and fall time of the CVA3404T may suffer due to stray capacitances associated with the PC Board and other components. It can be improved by carefully designing the PC Board where the output stage and input stage ground path are separated. Calogic will assist customers in the layout of

the PC Board that will result in quick EMI passage and better performance. The output peaking should be used only to restore the performance loss due to stray capacitances. Over peaking will cause excessive ringing that will have better results but poor EMI. The DC restore circuit is also important when considering the high frequency performance. Using CVA4501, DC Bias IC, better results can be obtained and high frequency performance can be maximized.

THERMAL CONSIDERATIONS

Power supply current increases as the input signal increases and consequently power dissipation also increases.

The CVA3404T cannot be used without heat sinking. *Figure 4* shows the power dissipated in each channel over the operating voltage range of the device. Under white screen conditions, i.e.: 25V output, dissipation increases to 9.5W total. The CVA3404T case temperature must be maintained below +100°C. If the maximum expected ambient temperature is +50°C, then a heat sink is needed with thermal resistance equal to or less than:

$$R_{th} = \frac{(100 - 50^{\circ}\text{C})}{9.5\text{W}} = 5.3^{\circ}\text{C/W}$$

The CVA3404T maximum load is 600Ω to ground or V⁺.

The output of CVA3404T is not short circuit proof. Any resistance to V⁺ or Ground should be > 600Ω.

FIGURE 4. APPLICATION CIRCUIT

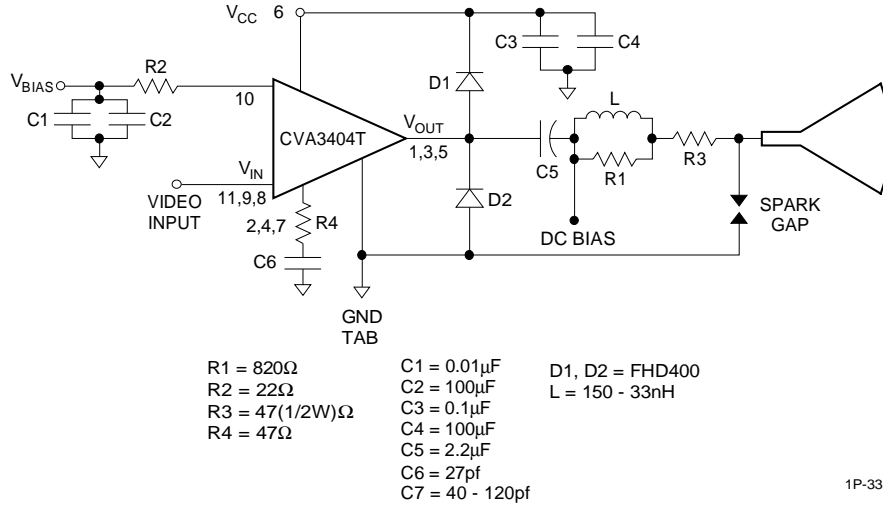

TYPICAL CHARACTERISTICS

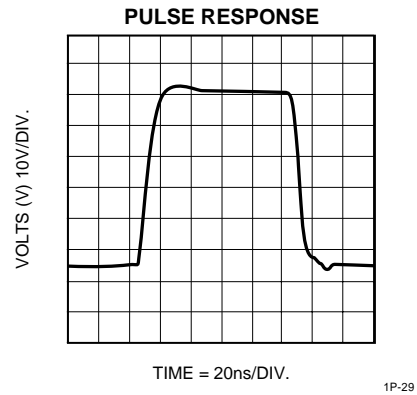
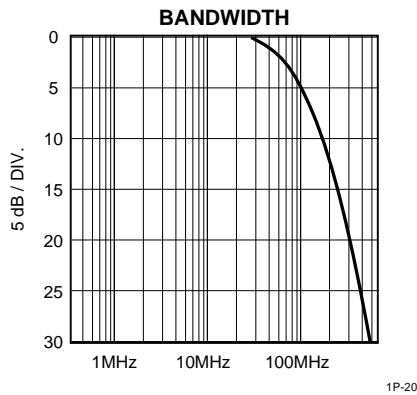
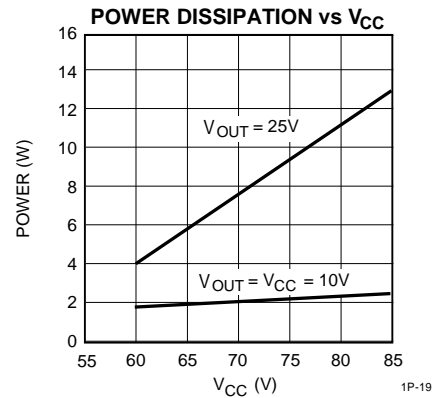
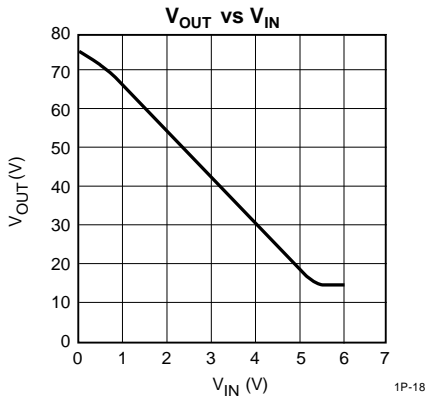

Information furnished by Calogic is believed to be accurate and reliable. However, no responsibility is assumed for its use: nor for any infringement of patents or other rights of third parties which may result from its use. No license is granted by implication or otherwise under any patent rights of Calogic.