

CEP4060ALR/CEB4060ALR

March 1998

N-Channel Enhancement Mode Field Effect Transistor

4

FEATURES

- 60V , 15A , $R_{DS(ON)}=80m\Omega$ @ $V_{GS}=10V$.
 $R_{DS(ON)}=85m\Omega$ @ $V_{GS}=5.0V$.
- Super high dense cell design for extremely low $R_{DS(ON)}$.
- High power and current handling capability.
- TO-220 & TO-263 package.

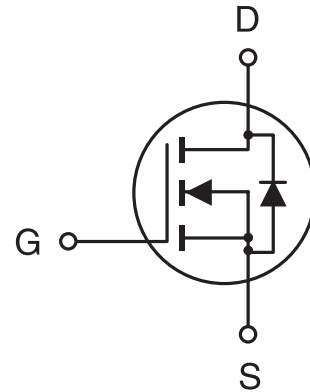

ABSOLUTE MAXIMUM RATINGS (Tc=25°C unless otherwise noted)

Parameter	Symbol	Limit	Unit
Drain-Source Voltage	VDS	60	V
Gate-Source Voltage	VGS	±16	V
Drain Current-Continuous -Pulsed	ID	15	A
	IDM	45	A
Drain-Source Diode Forward Current	IS	15	A
Maximum Power Dissipation @Tc=25°C Derate above 25°C	PD	50	W
		0.3	W/°C
Operating and Storage Temperature Range	TJ, TSTG	-65 to 175	°C

THERMAL CHARACTERISTICS

Thermal Resistance, Junction-to-Case	$R_{\theta JC}$	3	°C/W
Thermal Resistance, Junction-to-Ambient	$R_{\theta JA}$	62.5	°C/W

CEP4060ALR/CEB4060ALR

4

ELECTRICAL CHARACTERISTICS (Tc=25°C unless otherwise noted)

Parameter	Symbol	Condition	Min	Typ	Max	Unit
DRAIN-SOURCE AVALANCHE RATING^a						
Single Pulse Drain-Source Avalanche Energy	E _{AS}	V _{DD} =25V, I _D =150A		430		mJ
Maximum Drain-Source Avalanche Current	I _{AS}	L=25μH		150		A
OFF CHARACTERISTICS						
Drain-Source Breakdown Voltage	BV _{DSS}	V _{GS} =0V, I _D =250μA	60			V
Zero Gate Voltage Drain Current	I _{DSS}	V _{DS} =60V, V _{GS} =0V			250	μA
Gate-Body Leakage	I _{GSS}	V _{GS} =±16V, V _{DS} =0V			±100	nA
ON CHARACTERISTICS^a						
Gate Threshold Voltage	V _{GS(th)}	V _{DS} =V _{GS} , I _D =250μA	1	1.5	2	V
Drain-Source On-State Resistance	R _{DSON}	V _{GS} =5V, I _D =7.5A		72	85	mΩ
		V _{GS} =10V, I _D =15A		58	80	mΩ
On-State Drain Current	I _{D(ON)}	V _{GS} =5V, V _{DS} =10V	15			A
Forward Transconductance	g _{FS}	V _{DS} =10V, I _D =7.5A		11		S
SWITCHING CHARACTERISTICS^b						
Turn-On Delay Time	t _{D(ON)}	V _{DO} =30V, I _D =15A, V _{GS} =5V, R _{GEN} =51Ω		8	20	ns
Rise Time	t _r			140	250	ns
Turn-Off Delay Time	t _{D(OFF)}			30	100	ns
Fall Time	t _f			60	150	ns
Total Gate Charge	Q _g	V _{DS} =48V, I _D =15A, V _{GS} =5V		15	17	nC
Gate-Source Charge	Q _{gs}			3		nC
Gate-Drain Charge	Q _{gd}			2		nC

CEP4060ALR/CEB4060ALR

ELECTRICAL CHARACTERISTICS (T_c=25°C unless otherwise noted)

Parameter	Symbol	Condition	Min	Typ	Max	Unit
DYNAMIC CHARACTERISTICS^b						
Input Capacitance	C _{iss}	V _{DS} = 25V, V _{GS} = 0V f = 1.0MHz		430	600	pF
Output Capacitance	C _{oss}			126	200	pF
Reverse Transfer Capacitance	C _{rss}			28	50	pF
DRAIN-SOURCE DIODE CHARACTERISTICS^b						
Diode Forward Voltage	V _{SD}	V _{GS} = 0V, I _S = 7.5A		0.9	1.3	V

Notes

- a. Pulse Test: Pulse Width ≤ 300 μs, Duty Cycle ≤ 2%.
- b. Guaranteed by design, not subject to production testing.

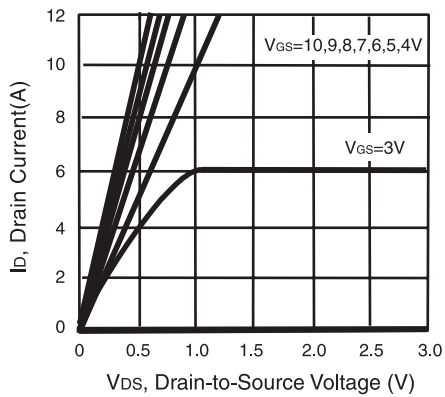

Figure 1. Output Characteristics

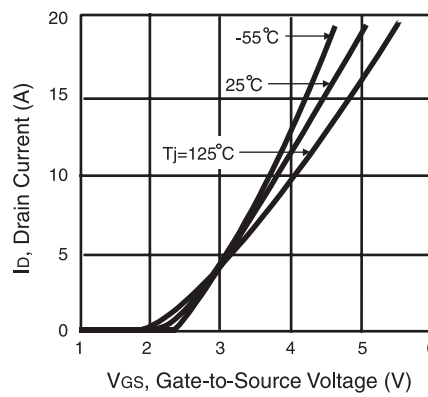

Figure 2. Transfer Characteristics

CEP4060ALR/CEB4060ALR

4

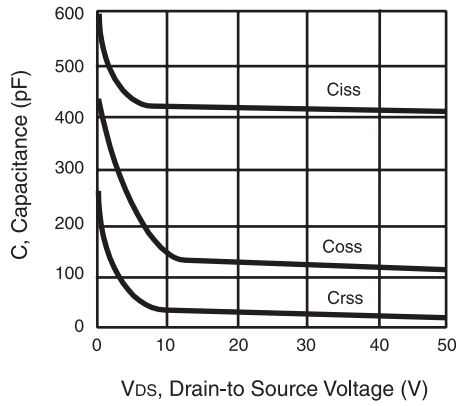

Figure 3. Capacitance

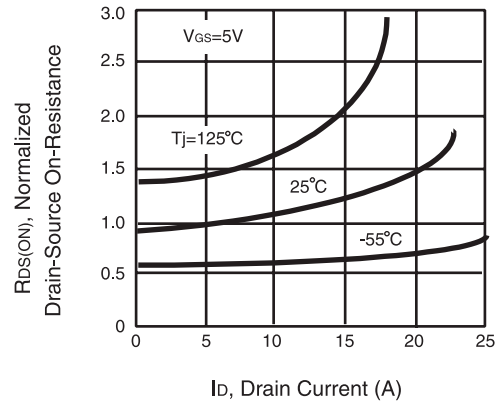

Figure 4. On-Resistance Variation with Drain Current and Temperature

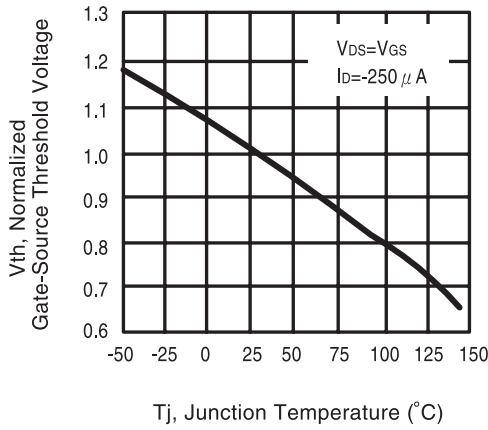

Figure 5. Gate Threshold Variation with Temperature

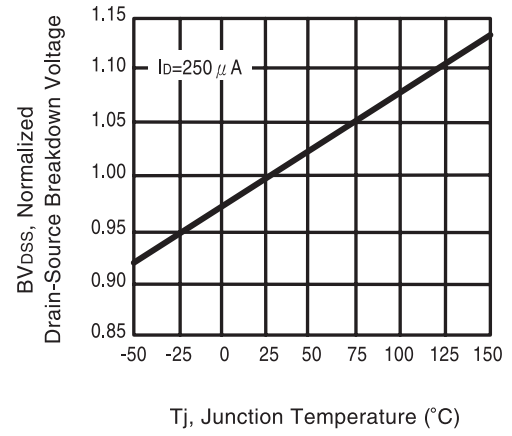

Figure 6. Breakdown Voltage Variation with Temperature

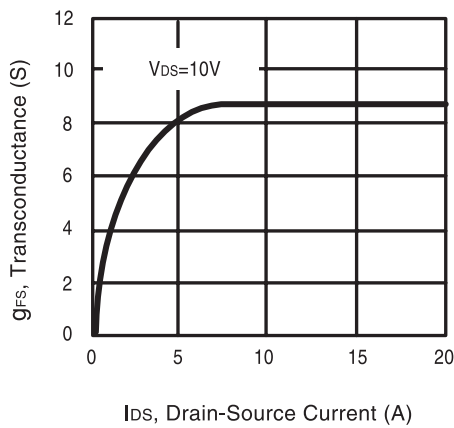

Figure 7. Transconductance Variation with Drain Current

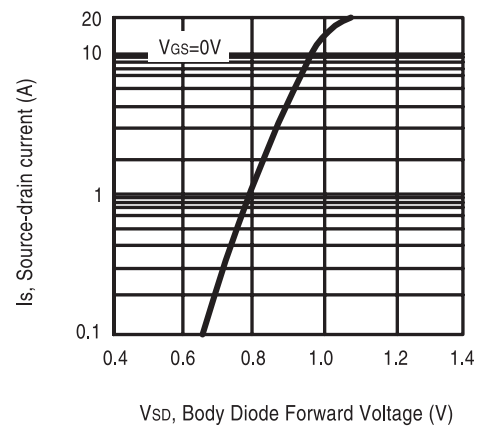

Figure 8. Body Diode Forward Voltage Variation with Source Current

CEP4060ALR/CEB4060ALR

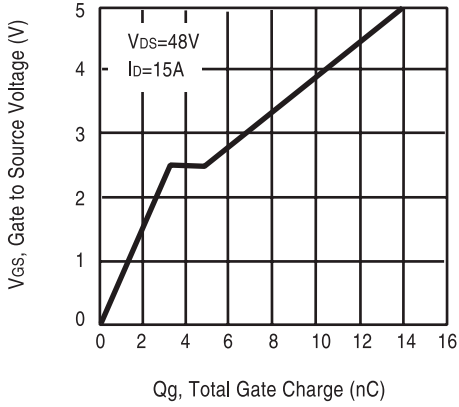

Figure 9. Gate Charge

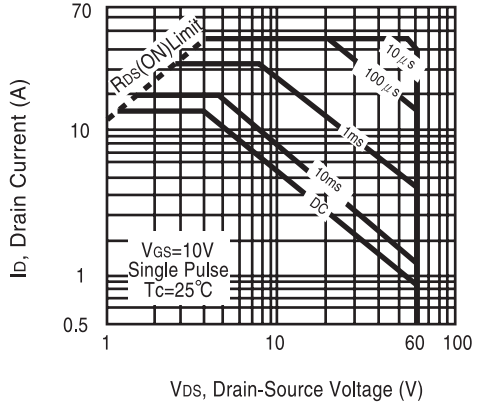

Figure 10. Maximum Safe Operating Area

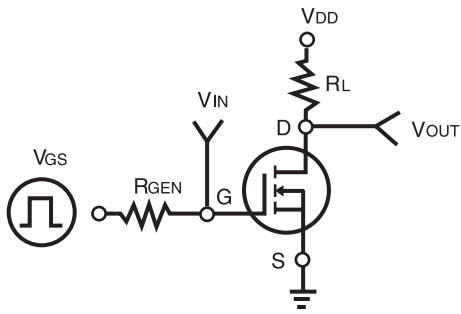

Figure 11. Switching Test Circuit

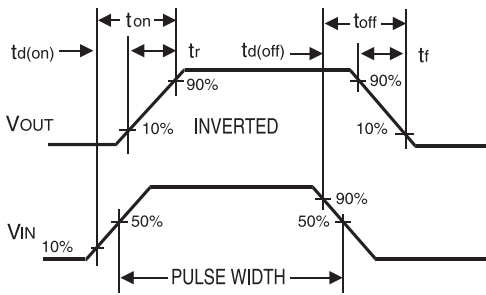

Figure 12. Switching Waveforms

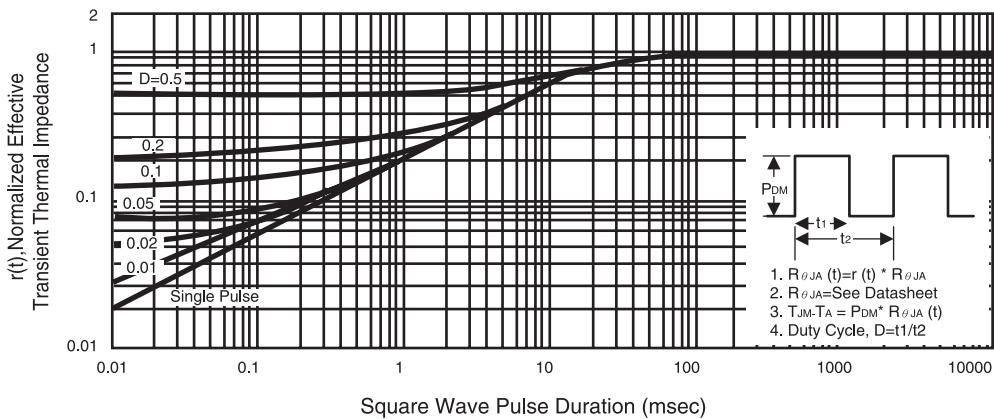

Figure 13. Normalized Thermal Transient Impedance Curve