

CEP6060LR/CEB6060LR

PRELIMINARY

N-Channel Enhancement Mode Field Effect Transistor

4

FEATURES

- 60V , 60A , $R_{DS(ON)}=20m\Omega$ @ $V_{GS}=10V$.
 $R_{DS(ON)}=25m\Omega$ @ $V_{GS}=5V$.
- Super high dense cell design for extremely low $R_{DS(ON)}$.
- High power and current handling capability.
- TO-220 & TO-263 package.

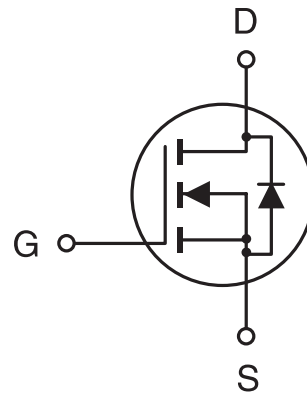

ABSOLUTE MAXIMUM RATINGS ($T_c=25^\circ\text{C}$ unless otherwise noted)

Parameter	Symbol	Limit	Unit
Drain-Source Voltage	V_{DS}	60	V
Gate-Source Voltage	V_{GS}	± 16	V
Drain Current-Continuous -Pulsed	I_D	60	A
	I_{DM}	144	A
Drain-Source Diode Forward Current	I_S	60	A
Maximum Power Dissipation @ $T_c=25^\circ\text{C}$ Derate above 25°C	P_D	100	W
		0.67	W/ $^\circ\text{C}$
Operating and Storage Temperature Range	T_J, T_{STG}	-65 to 175	$^\circ\text{C}$

THERMAL CHARACTERISTICS

Thermal Resistance, Junction-to-Case	$R_{\theta JC}$	1.5	$^\circ\text{C/W}$
Thermal Resistance, Junction-to-Ambient	$R_{\theta JA}$	62.5	$^\circ\text{C/W}$

CEP6060LR/CEB6060LR

4

ELECTRICAL CHARACTERISTICS (Tc=25°C unless otherwise noted)

Parameter	Symbol	Condition	Min	Typ	Max	Unit
DRAIN-SOURCE AVALANCHE RATING^a						
Single Pulse Drain-Source Avalanche Energy	E _{AS}	V _{DD} =25V, I _D =150A		430		mJ
Maximum Drain-Source Avalanche Current	I _{AS}	L=25μH		150		A
OFF CHARACTERISTICS						
Drain-Source Breakdown Voltage	BV _{DSS}	V _{GS} =0V, I _D =250μA	60			V
Zero Gate Voltage Drain Current	I _{DSS}	V _{DS} =60V, V _{GS} =0V			25	μA
Gate-Body Leakage	I _{GSS}	V _{GS} =±16V, V _{DS} =0V			±100	nA
ON CHARACTERISTICS^a						
Gate Threshold Voltage	V _{GS(th)}	V _{DS} =V _{GS} , I _D =250μA	1	1.4	2	V
Drain-Source On-State Resistance	R _{DS(ON)}	V _{GS} =5V, I _D =24A		19	25	mΩ
		V _{GS} =10V, I _D =24A		15	20	mΩ
On-State Drain Current	I _{D(ON)}	V _{GS} =5V, V _{DS} =10V	60			A
Forward Transconductance	g _{FS}	V _{DS} =10V, I _D =24A		39		S
SWITCHING CHARACTERISTICS^b						
Turn-On Delay Time	t _{D(ON)}	V _{DD} =30V, I _D =48A, V _{GS} =5V V _{GEN} =15V R _{GS} =15Ω		20	30	ns
Rise Time	t _r			400	500	ns
Turn-Off Delay Time	t _{D(OFF)}			75	100	ns
Fall Time	t _f			260	300	ns
Total Gate Charge	Q _g	V _{DS} =48V, I _D =48A, V _{GS} =5V		58	60	nC
Gate-Source Charge	Q _{gs}			8		nC
Gate-Drain Charge	Q _{gd}			13		nC

CEP6060LR/CEB6060LR

ELECTRICAL CHARACTERISTICS (T_c=25°C unless otherwise noted)

Parameter	Symbol	Condition	Min	Typ	Max	Unit
DYNAMIC CHARACTERISTICS^b						
Input Capacitance	C _{iss}	V _{DS} = 25V, V _{GS} = 0V f = 1.0MHz		1565	400	pF
Output Capacitance	C _{oss}			441	200	pF
Reverse Transfer Capacitance	C _{rss}			104	50	pF
DRAIN-SOURCE DIODE CHARACTERISTICS^a						
Diode Forward Voltage	V _{SD}	V _{GS} = 0V, I _S = 24A		0.8	1.3	V

Notes

- a. Pulse Test: Pulse Width ≤ 300 μs, Duty Cycle ≤ 2%.
- b. Guaranteed by design, not subject to production testing.

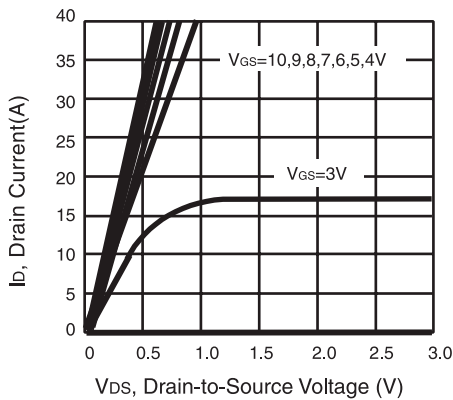

Figure 1. Output Characteristics

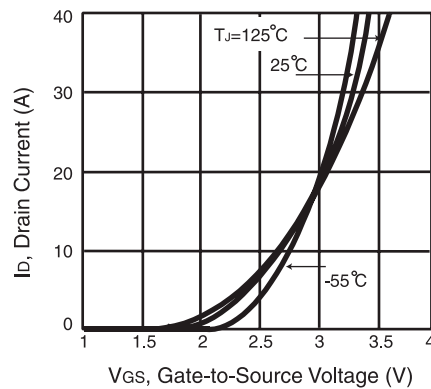

Figure 2. Transfer Characteristics

CEP6060LR/CEB6060LR

4

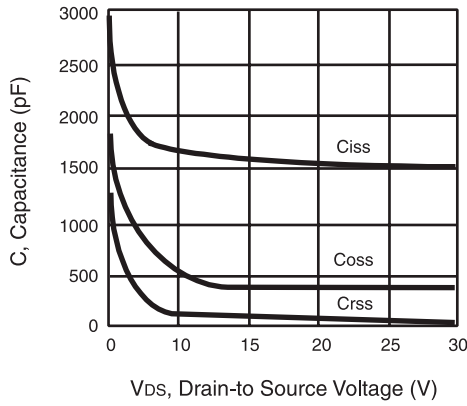

Figure 3. Capacitance

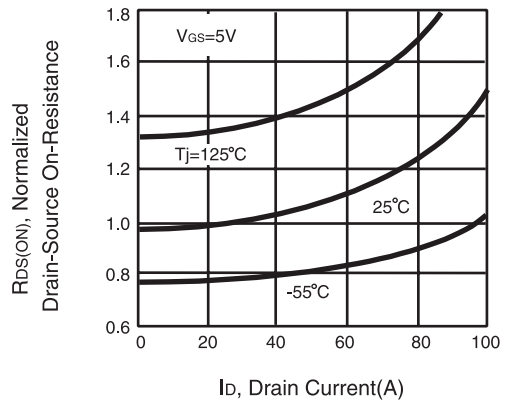

Figure 4. On-Resistance Variation with Drain Current and Temperature

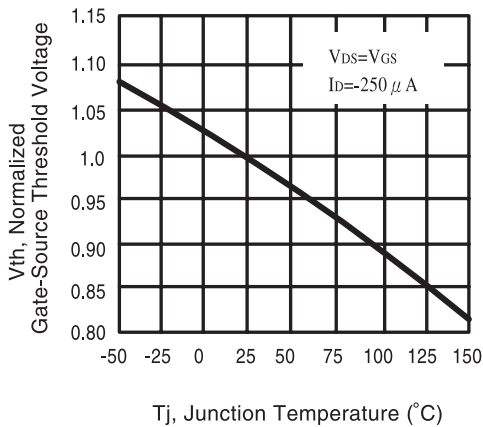

Figure 5. Gate Threshold Variation with Temperature

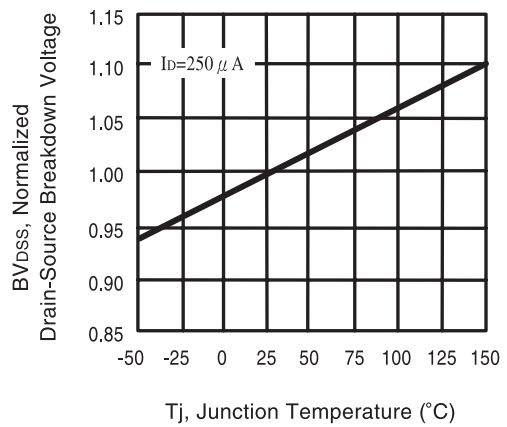

Figure 6. Breakdown Voltage Variation with Temperature

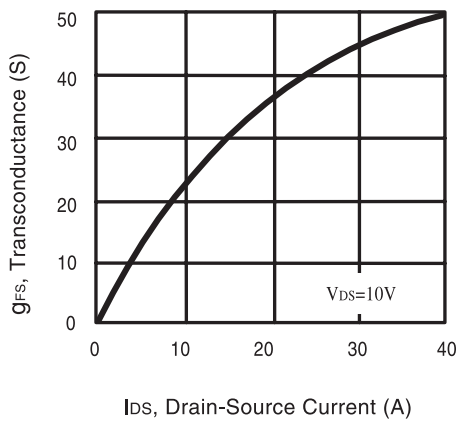

Figure 7. Transconductance Variation with Drain Current

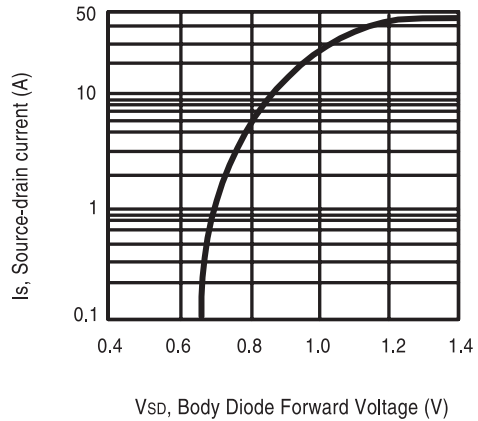

Figure 8. Body Diode Forward Voltage Variation with Source Current

CEP6060LR/CEB6060LR

4

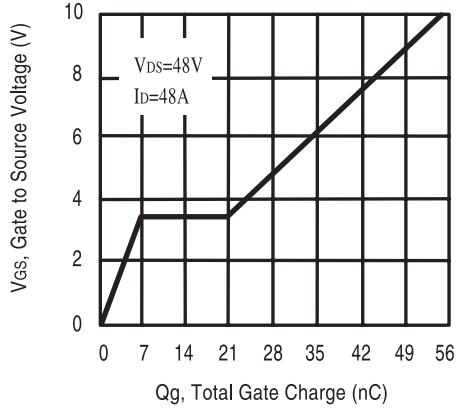

Figure 9. Gate Charge

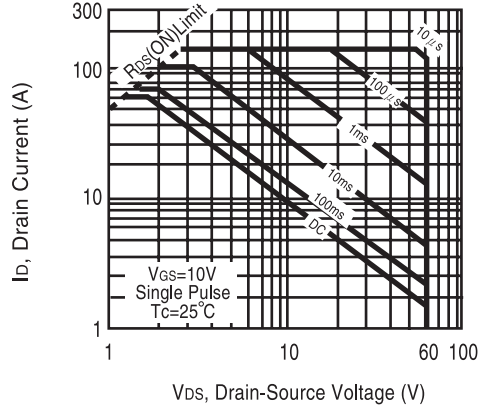

Figure 10. Maximum Safe Operating Area

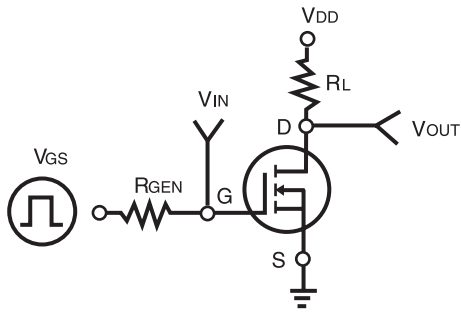

Figure 11. Switching Test Circuit

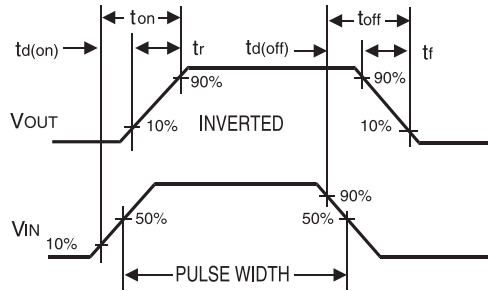

Figure 12. Switching Waveforms

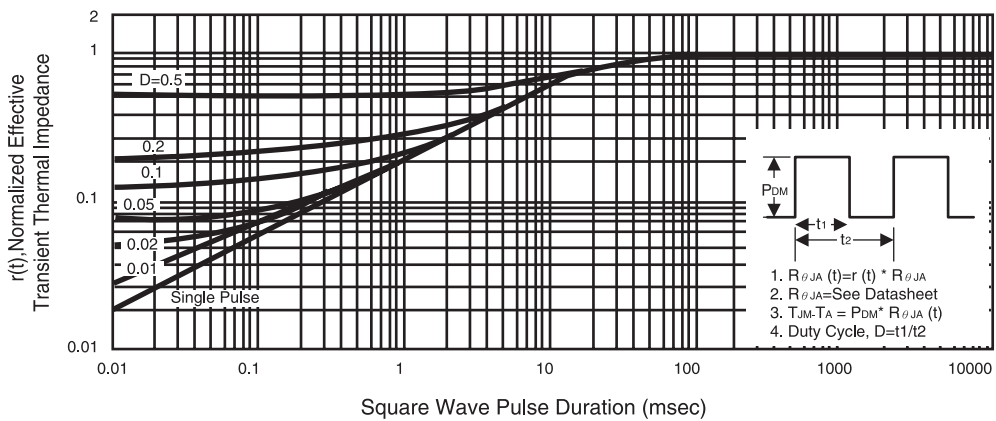

Figure 13. Normalized Thermal Transient Impedance Curve