

CEP703ALS2/CEB703ALS2

ELECTRICAL CHARACTERISTICS (T_c=25°C unless otherwise noted)

Parameter	Symbol	Condition	Min	Typ	Max	Unit
OFF CHARACTERISTICS						
Drain-Source Breakdown Voltage	BV _{DSS}	V _{GS} =0V, I _D =250μA	30			V
Zero Gate Voltage Drain Current	I _{DSS}	V _{DS} =24V, V _{GS} =0V			10	μA
Gate-Body Leakage	I _{GSS}	V _{GS} =±20V, V _{DS} =0V			±100	nA
ON CHARACTERISTICS^a						
Gate Threshold Voltage	V _{GS(th)}	V _{DS} =V _{GS} , I _D =250μA	1	1.7	3	V
Drain-Source On-State Resistance	R _{DS(on)}	V _{GS} =10V, I _D =25A		14	17	mΩ
		V _{GS} =4.5V, I _D =10A		22	30	mΩ
On-State Drain Current	I _{D(on)}	V _{GS} =10V, V _{DS} =10V	60			A
Forward Transconductance	g _{FS}	V _{DS} =10V, I _D =25A		30		S
DYNAMIC CHARACTERISTICS^b						
Input Capacitance	C _{iss}	V _{DS} =15V, V _{GS} =0V f=1.0MHz		1150	1500	pF
Output Capacitance	C _{oss}			540	700	pF
Reverse Transfer Capacitance	C _{rss}			230	300	pF
SWITCHING CHARACTERISTICS^b						
Turn-On Delay Time	t _{D(on)}	V _{DD} =15V, I _D =25A, V _{GS} =10V, R _{GEN} =24Ω		18	23	ns
Rise Time	t _r			120	180	ns
Turn-Off Delay Time	t _{D(off)}			80	120	ns
Fall Time	t _f			60	165	ns
Total Gate Charge	Q _g	V _{DS} =10V, I _D =25A, V _{GS} =10V		30	50	nC
Gate-Source Charge	Q _{gs}			6		nC
Gate-Drain Charge	Q _{gd}			7		nC

CEP703ALS2/CEB703ALS2

BODY DIODE & SCHOTTKY DIODE RATINGS AND CHARACTERISTICS

Parameter	Symbol	Condition	Min	Typ	Max	Unit
DRAIN-SOURCE DIODE CHARACTERISTICS ^a						
Body Diode Forward Voltage	V_{SD}	$V_{GS} = 0V, I_s = 25A$			1.3	V
Schottky Forward Voltage	V_F	$I_F = 2A, T_c = 25^\circ C$			0.55	V
Average Forward Rectified Current	$I_{F(AV)}$				2	A

Notes

a. Pulse Test: Pulse Width $\leq 300 \mu s$, Duty Cycle $\leq 2\%$.

b. Guaranteed by design, not subject to production testing.

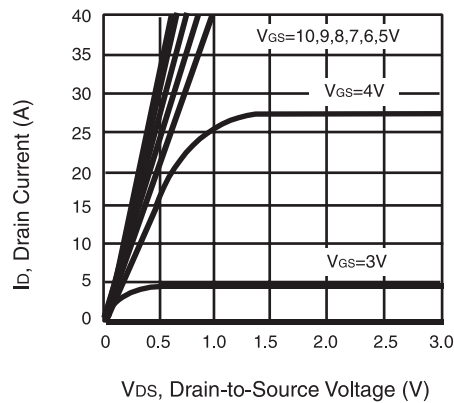

Figure 1. Output Characteristics

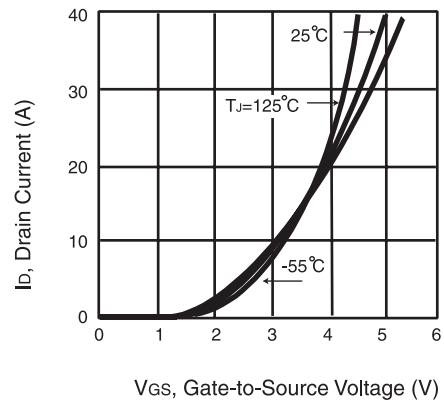

Figure 2. Transfer Characteristics

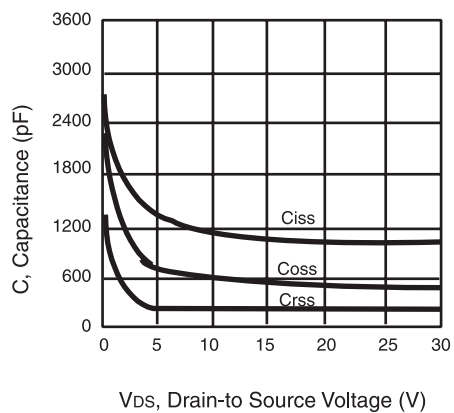

Figure 3. Capacitance

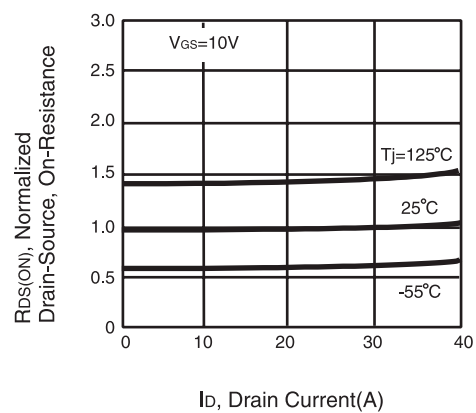

Figure 4. On-Resistance Variation with Drain Current and Temperature

15

CEP703ALS2/CEB703ALS2

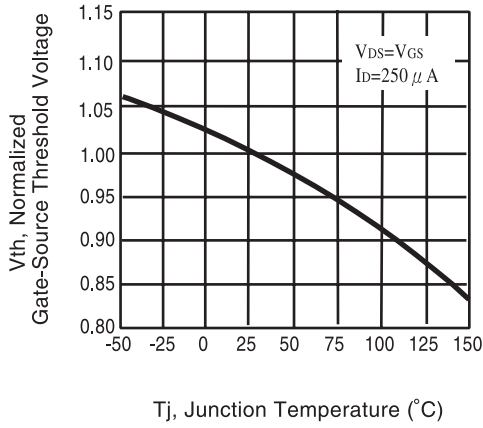

Figure 5. Gate Threshold Variation with Temperature

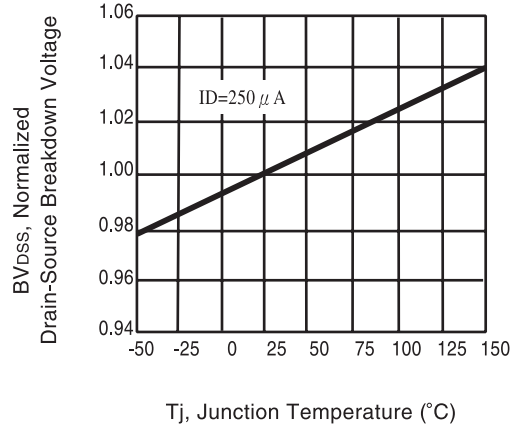

Figure 6. Breakdown Voltage Variation with Temperature

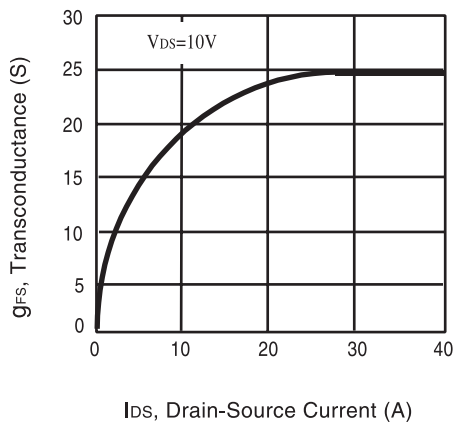

Figure 7. Transconductance Variation with Drain Current

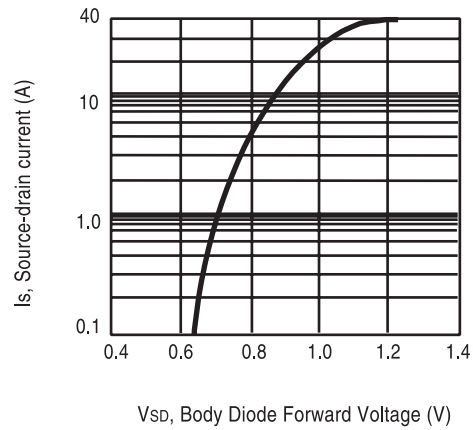

Figure 8. Body Diode Forward Voltage Variation with Source Current

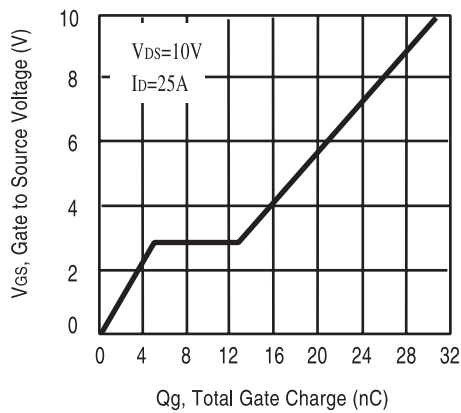

Figure 9. Gate Charge

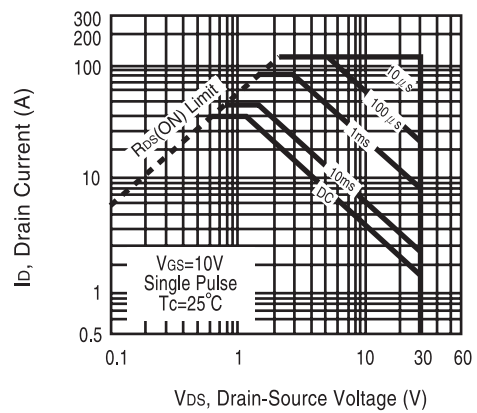

Figure 10. Maximum Safe Operating Area

CEP703ALS2/CEB703ALS2



PRELIMINARY

N-Channel Logic Level Enhancement Mode Field Effect Transistor

FEATURES

- 30V , 40A , $R_{DS(ON)}=17m\Omega$ @ $V_{GS}=10V$.
 $R_{DS(ON)}=30m\Omega$ @ $V_{GS}=4.5V$.
- Super high dense cell design for extremely low $R_{DS(ON)}$.
- High power and current handling capability.
- TO-220 & TO-263 package.

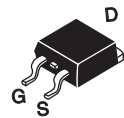
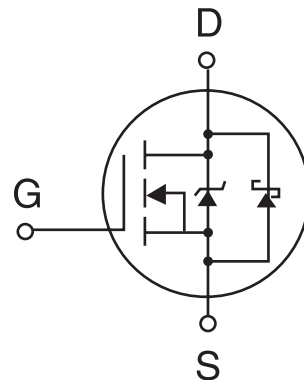

CEB SERIES
TO-263(DD-PAK)

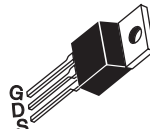

CEP SERIES
TO-220

ABSOLUTE MAXIMUM RATINGS (Tc=25°C unless otherwise noted)

Parameter	Symbol	Limit	Unit
Drain-Source Voltage	V _{DS}	30	V
Gate-Source Voltage	V _{GS}	±20	V
Drain Current-Continuous @T _J =125°C -Pulsed	I _D	40	A
	I _{DM}	120	A
Drain-Source Diode Forward Current	I _S	40	A
Maximum Power Dissipation @T _c =25°C Derate above 25°C	P _D	50	W
		0.4	W/°C
Operating and Storage Temperature Range	T _J , T _{STG}	-65 to 175	°C

15

THERMAL CHARACTERISTICS

Thermal Resistance, Junction-to-Case	R _{θJC}	3	°C/W
Thermal Resistance, Junction-to-Ambient	R _{θJA}	62.5	°C/W

CEP703ALS2/CEB703AL2

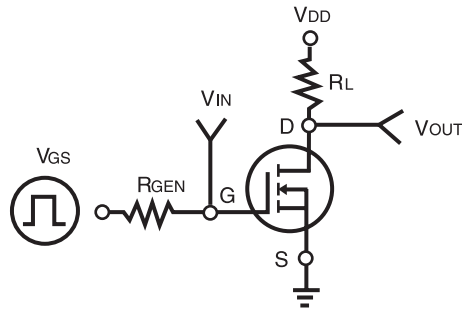

Figure 11. Switching Test Circuit

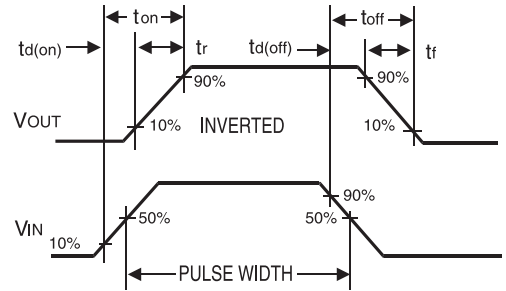

Figure 12. Switching Waveforms

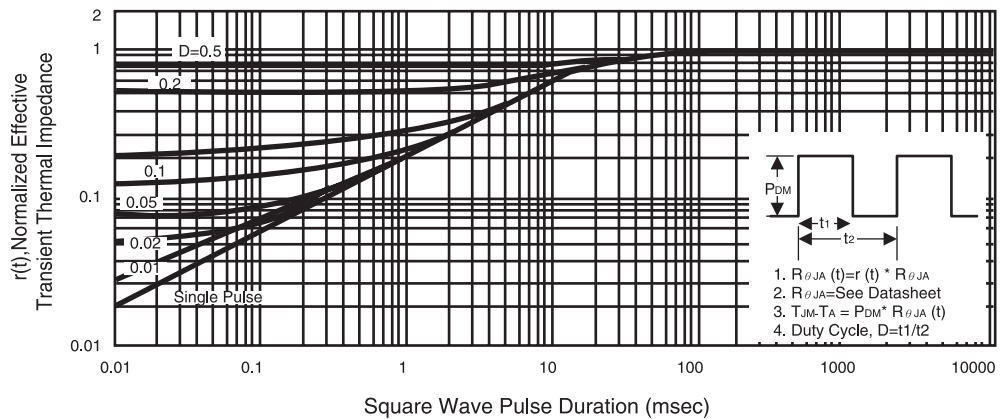

Figure 13. Normalized Thermal Transient Impedance Curve