

CEM9435

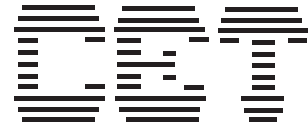

March 1998

P-Channel Enhancement Mode MOSFET

5

FEATURES

- -30V , -5.1A , $R_{DS(ON)}=55m\Omega$ @ $V_{GS}=-10V$.
 $R_{DS(ON)}=105m\Omega$ @ $V_{GS}=-4.5V$.
- Super high dense cell design for extremely low $R_{DS(ON)}$.
- High power and current handling capability.
- Surface Mount Package.

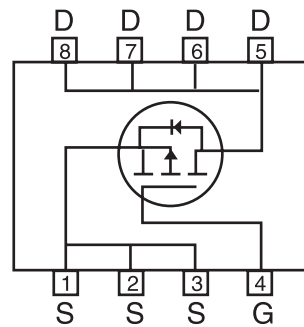
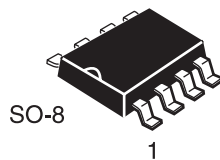

ABSOLUTE MAXIMUM RATINGS ($T_A=25^\circ C$ unless otherwise noted)

Parameter	Symbol	Limit	Unit
Drain-Source Voltage	V_{DS}	-30	V
Gate-Source Voltage	V_{GS}	± 20	V
Drain Current-Continuous ^a @ $T_J=125^\circ C$ -Pulsed ^b	I_D	± 5.1	A
	I_{DM}	± 15	A
Drain-Source Diode Forward Current ^a	I_S	-2.6	A
Maximum Power Dissipation ^a	P_D	2.5	W
Operating Junction and Storage Temperature Range	T_J, T_{STG}	-55 to 150	$^\circ C$

THERMAL CHARACTERISTICS

Thermal Resistance, Junction-to-Ambient ^a	$R_{\theta JA}$	50	$^\circ C/W$
--	-----------------	----	--------------

CEM9435

ELECTRICAL CHARACTERISTICS (TA=25°C unless otherwise noted)

5

Parameter	Symbol	Condition	Min	Typ ^c	Max	Unit
OFF CHARACTERISTICS						
Drain-Source Breakdown Voltage	BV _{DSS}	V _{GS} =0V, I _D =-250μA	-30			V
Zero Gate Voltage Drain Current	I _{DSS}	V _{DS} =-24V, V _{GS} =0V			-1	μA
Gate-Body Leakage	I _{GSS}	V _{GS} =±20V, V _{DS} =0V			±100	nA
ON CHARACTERISTICS^b						
Gate Threshold Voltage	V _{GS(th)}	V _{DS} =V _{GS} , I _D = -250μA	-1	-1.5	-3	V
Drain-Source On-State Resistance	R _{DS(ON)}	V _{GS} = -10V, I _D = -4.6A			55	mΩ
		V _{GS} = -4.5V, I _D = -2.0A			105	mΩ
On-State Drain Current	I _{D(ON)}	V _{DS} = -10V, V _{GS} = -10V	-15			A
Forward Transconductance	g _{FS}	V _{DS} = -15V, I _D = -4.6A		9		S
DYNAMIC CHARACTERISTICS^c						
Input Capacitance	C _{ISS}	V _{DS} = -15V, V _{GS} = 0V f = 1.0MHz		860	1120	pF
Output Capacitance	C _{OSS}			458	600	pF
Reverse Transfer Capacitance	C _{RSS}			140	190	pF
SWITCHING CHARACTERISTICS^c						
Turn-On Delay Time	t _{D(ON)}	V _{DD} = -15V, I _D = -1A, V _{GEN} = -10V, R _{GEN} = 6Ω		9	30	ns
Rise Time	t _r			15	60	ns
Turn-Off Delay Time	t _{D(OFF)}			75	120	ns
Fall Time	t _f			40	100	ns
Total Gate Charge	Q _g	V _{DS} = -15V, I _D = -4.6A, V _{GS} = -10V		23	40	nC
Gate-Source Charge	Q _{gs}			4		nC
Gate-Drain Charge	Q _{gd}			6		nC

CEM9435

ELECTRICAL CHARACTERISTICS ($T_A=25^\circ\text{C}$ unless otherwise noted)

5

Parameter	Symbol	Condition	Min	Typ ^c	Max	Unit
DRAIN-SOURCE DIODE CHARACTERISTICS^b						
Diode Forward Voltage	V_{SD}	$V_{GS} = 0V, I_S = -2.6A$			-1.2	V

Notes

- a. Surface Mounted on FR4 Board, $t \leq 10\text{sec}$.
- b. Pulse Test: Pulse Width $\leq 300\mu\text{s}$, Duty Cycle $\leq 2\%$.
- c. Guaranteed by design, not subject to production testing.

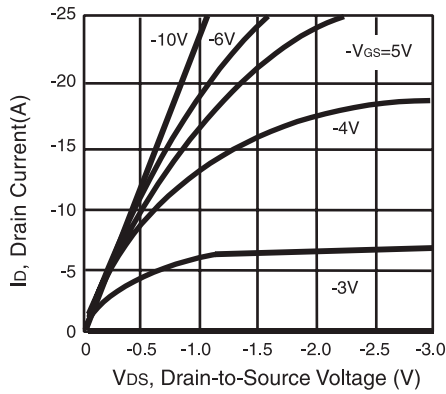

Figure 1. Output Characteristics

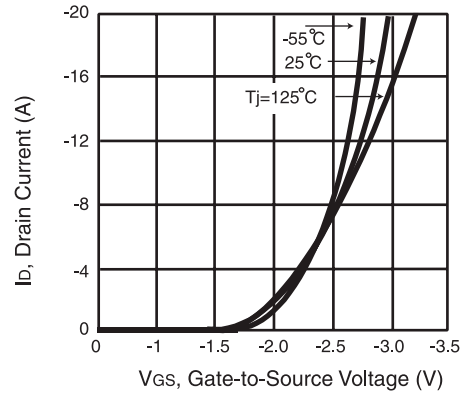

Figure 2. Transfer Characteristics

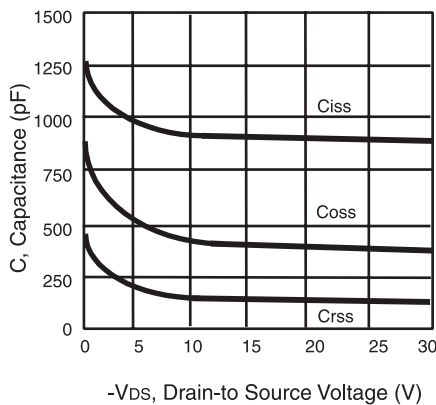

Figure 3. Capacitance

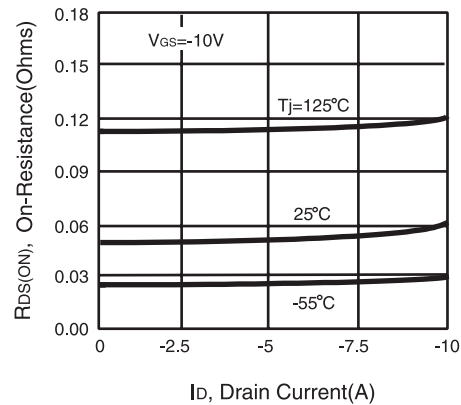

Figure 4. On-Resistance Variation with Drain Current and Temperature

CEM9435

5

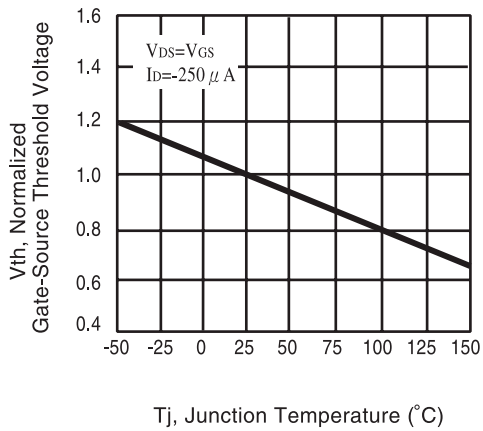

Figure 5. Gate Threshold Variation with Temperature

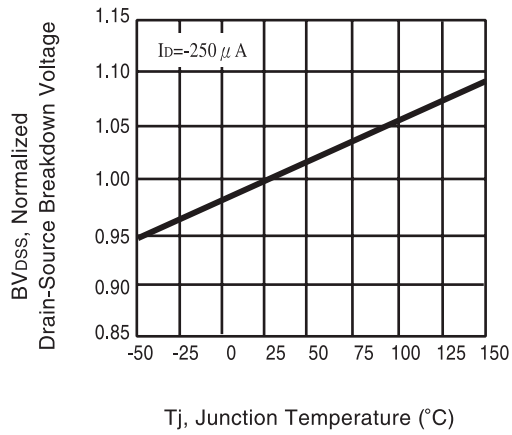

Figure 6. Breakdown Voltage Variation with Temperature

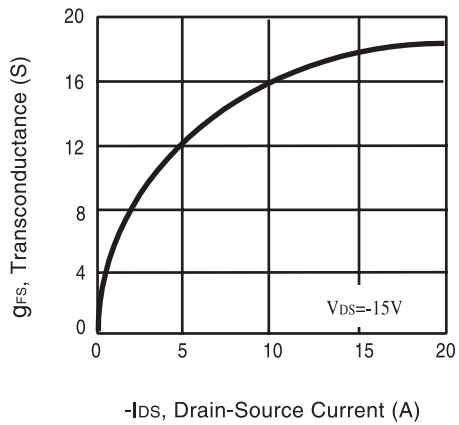

Figure 7. Transconductance Variation with Drain Current

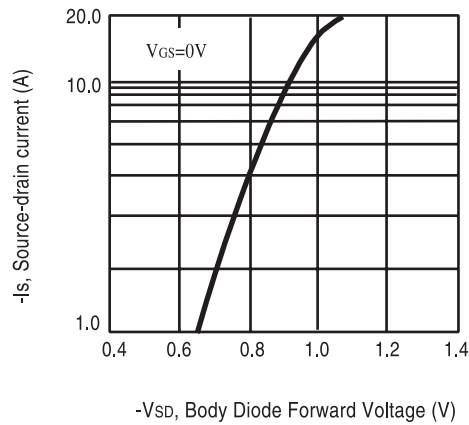

Figure 8. Body Diode Forward Voltage Variation with Source Current

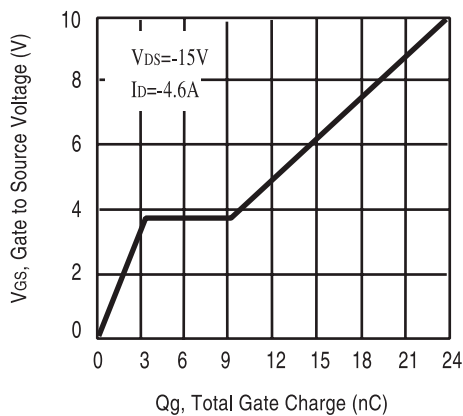

Figure 9. Gate Charge

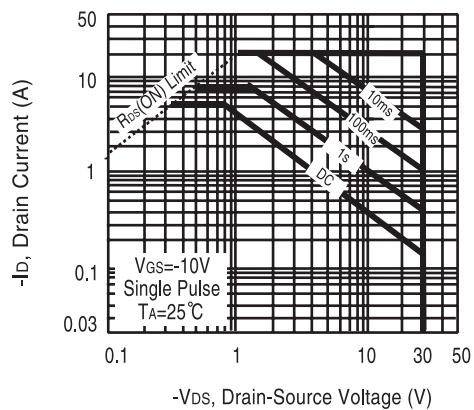

Figure 10. Maximum Safe Operating Area

CEM9435

5

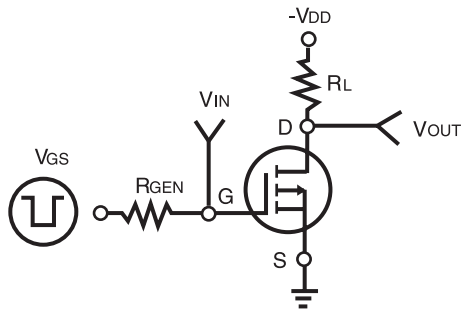

Figure 11. Switching Test Circuit

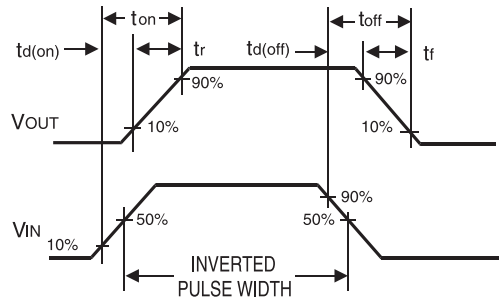

Figure 12. Switching Waveforms

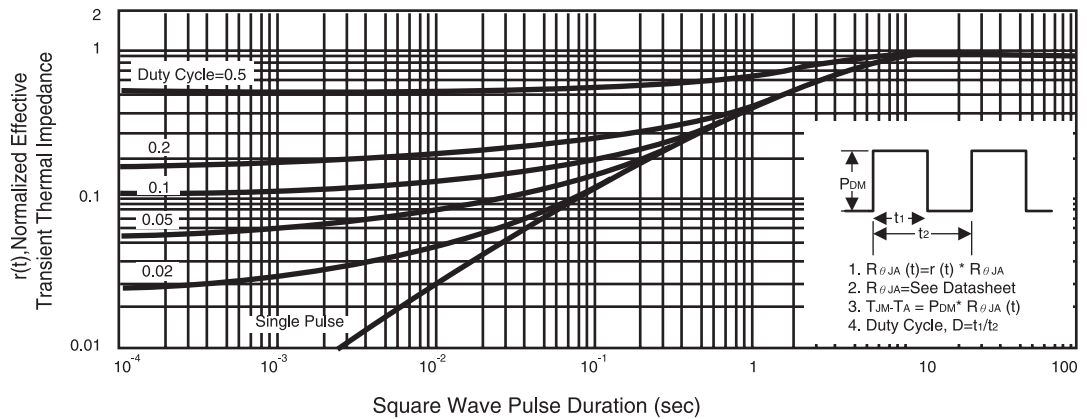

Figure 13. Normalized Thermal Transient Impedance Curve