



BSS138

March 1998

N-Channel Enhancement Mode Field Effect Transistor

FEATURES

- 50V , 0.22A , $R_{DS(ON)}=3.5\Omega$ @ $V_{GS}=10V$.
 $R_{DS(ON)}=6\Omega$ @ $V_{GS}=4.5V$.
- High dense cell design for low $R_{DS(ON)}$.
- Rugged and reliable.
- SOT-23 package.

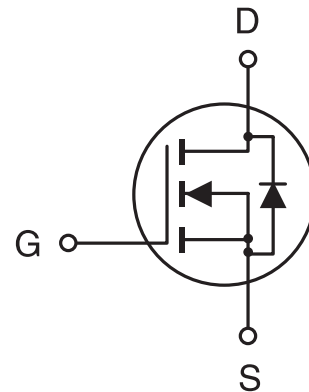
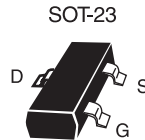

7

ABSOLUTE MAXIMUM RATINGS ($T_A=25^\circ C$ unless otherwise noted)

Parameter	Symbol	Limit	Unit
Drain-Source Voltage	V_{DS}	50	V
Gate-Source Voltage	V_{GS}	± 20	V
Drain Current-Continuous ^a @ $T_J=125^\circ C$ -Pulsed ^b	I_D	220	mA
	I_{DM}	880	mA
Drain-Source Diode Forward Current ^a	I_S	220	mA
Maximum Power Dissipation ^a	P_D	300	mW
Operating Junction and Storage Temperature Range	T_J, T_{STG}	-55 to 150	$^\circ C$

THERMAL CHARACTERISTICS

Thermal Resistance, Junction-to-Ambient ^a	$R_{\theta JA}$	417	$^\circ C/W$
--	-----------------	-----	--------------

BSS138

ELECTRICAL CHARACTERISTICS (T_A=25°C unless otherwise noted)

Parameter	Symbol	Condition	Min	Typ	Max	Unit
OFF CHARACTERISTICS						
Drain-Source Breakdown Voltage	BV _{DSS}	V _{GS} =0V, I _D =250μA	50			V
Zero Gate Voltage Drain Current	I _{DSS}	V _{DS} =50V, V _{GS} =0V			0.5	μA
Gate-Body Leakage	I _{GSS}	V _{GS} =±20V, V _{DS} =0V			±100	nA
ON CHARACTERISTICS^b						
Gate Threshold Voltage	V _{GS(th)}	V _{DS} =V _{GS} , I _D =1mA	0.8	1.5	1.6	V
Drain-Source On-State Resistance	R _{DS(ON)}	V _{GS} =10V, I _D =220mA		1.6	3.5	Ω
		V _{GS} =4.5V, I _D =220mA		2.5	6	Ω
On-State Drain Current	I _{D(ON)}	V _{DS} =7V, V _{GS} =10V	500			mA
Forward Transconductance	g _{FS}	V _{DS} =10V, I _D =220mA	120	450		mS
DYNAMIC CHARACTERISTICS^c						
Input Capacitance	C _{ISS}	V _{DS} =25V, V _{GS} =0V f=1.0MHz		42	55	pF
Output Capacitance	C _{OSS}			11	15	pF
Reverse Transfer Capacitance	C _{RSS}			7	10	pF
SWITCHING CHARACTERISTICS^c						
Turn-On Delay Time	t _{D(ON)}	V _{DD} =30V, I _D =290mA, V _{GS} =10V, R _{GEN} =50Ω		6	8	ns
Rise Time	t _r			9	12	ns
Turn-Off Delay Time	t _{D(OFF)}			12	16	ns
Fall Time	t _f			16	22	ns

BSS138

ELECTRICAL CHARACTERISTICS ($T_A=25^\circ\text{C}$ unless otherwise noted)

Parameter	Symbol	Condition	Min	Typ	Max	Unit
DRAIN-SOURCE DIODE CHARACTERISTICS^b						
Diode Forward Voltage	V_{SD}	$V_{GS} = 0\text{V}, I_S = 440\text{mA}$		0.8	1.4	V

Notes

- a. Surface Mounted on FR4 Board, $t \leq 10\text{sec}$.
- b. Pulse Test: Pulse Width $\leq 300 \mu\text{s}$, Duty Cycle $\leq 2\%$.
- c. Guaranteed by design, not subject to production testing.

7

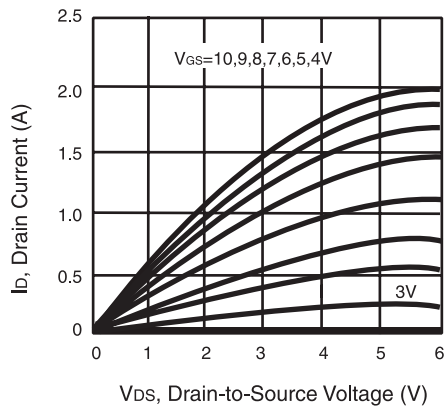

Figure 1. Output Characteristics

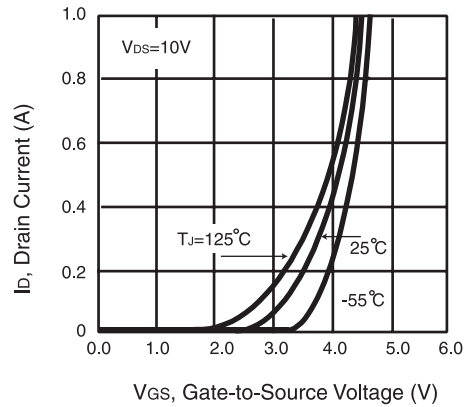

Figure 2. Transfer Characteristics

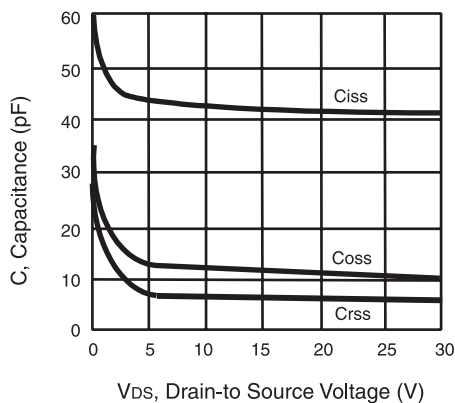

Figure 3. Capacitance

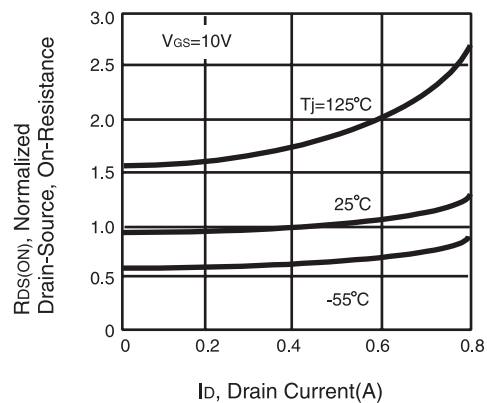

Figure 4. On-Resistance Variation with Drain Current and Temperature

BSS138

7

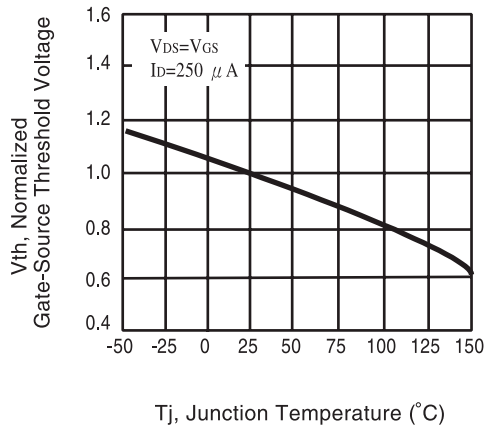

Figure 5. Gate Threshold Variation with Temperature

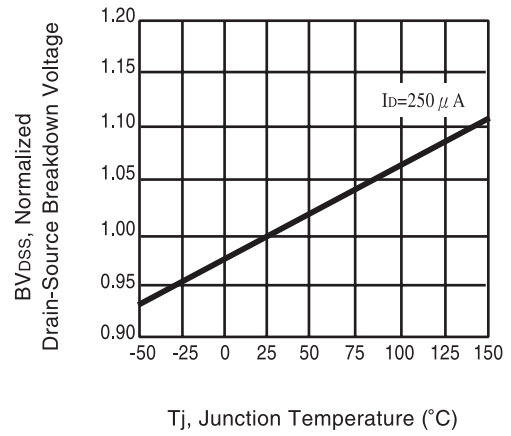

Figure 6. Breakdown Voltage Variation with Temperature

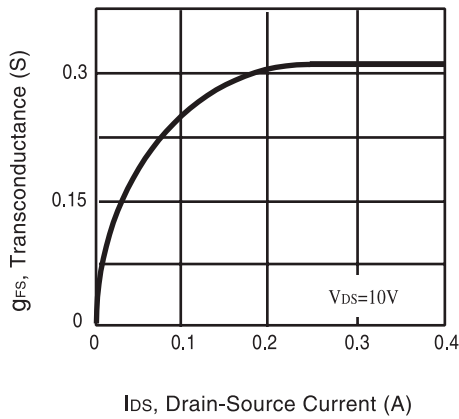

Figure 7. Transconductance Variation with Drain Current

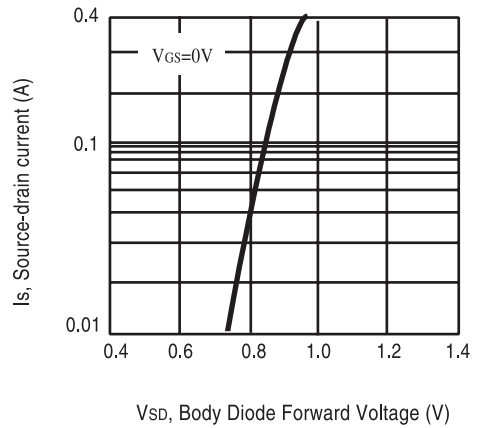

Figure 8. Body Diode Forward Voltage Variation with Source Current

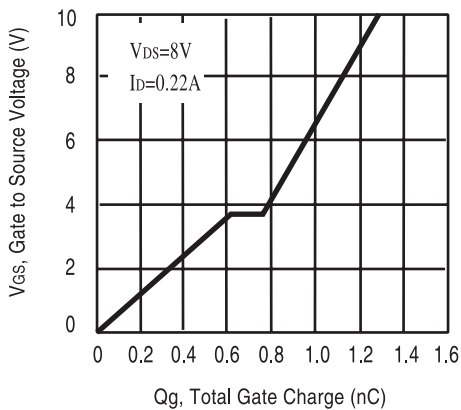

Figure 9. Gate Charge

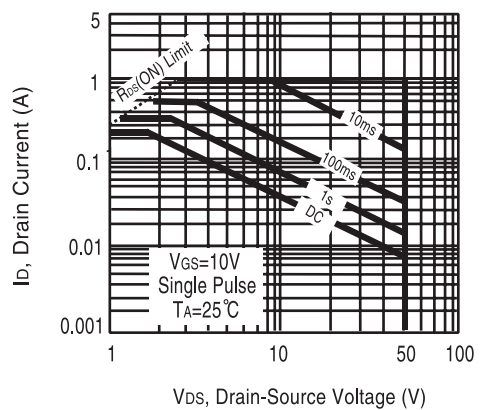

Figure 10. Maximum Safe Operating Area

BSS138

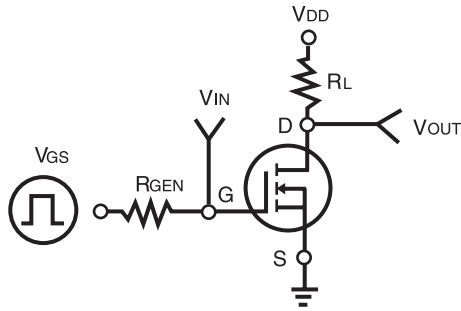

Figure 11. Switching Test Circuit

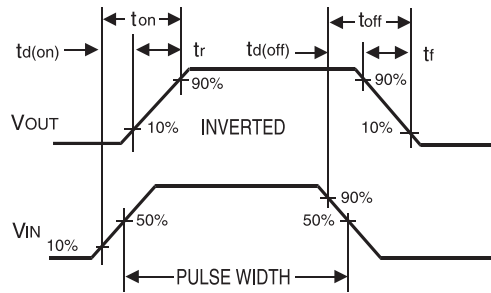

Figure 12. Switching Waveforms

7

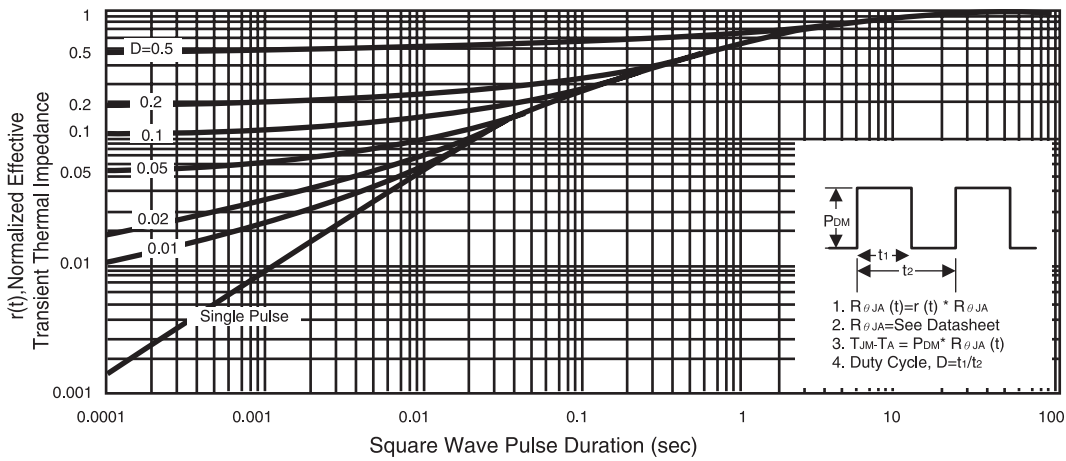

Figure 13. Normalized Thermal Transient Impedance Curve