

# CEA3055L

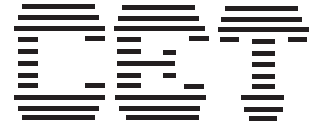

March 1998

## N-Channel Enhancement Mode Field Effect Transistor

### FEATURES

- 60V , 3.7A ,  $R_{DS(ON)}=100m\Omega$  @  $V_{GS}=10V$ .  
 $R_{DS(ON)}=120m\Omega$  @  $V_{GS}=4.5V$ .
- High dense cell design for low  $R_{DS(ON)}$ .
- Rugged and reliable.
- SOT-89 Package.

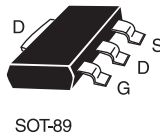
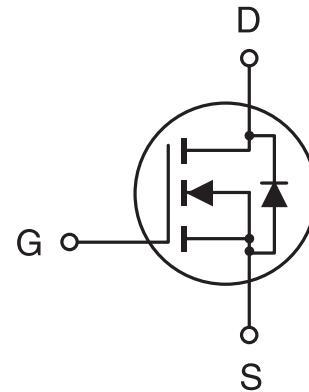

9

### ABSOLUTE MAXIMUM RATINGS ( $T_A=25^\circ\text{C}$ unless otherwise noted)

Parameter	Symbol	Limit	Unit
Drain-Source Voltage	$V_{DS}$	60	V
Gate-Source Voltage	$V_{GS}$	$\pm 20$	V
Drain Current-Continuous <sup>a</sup> @ $T_J=125^\circ\text{C}$ -Pulsed <sup>b</sup>	$I_D$	$\pm 3.7$	A
	$I_{DM}$	$\pm 25$	A
Drain-Source Diode Forward Current <sup>a</sup>	$I_S$	2.5	A
Maximum Power Dissipation <sup>a</sup>	PD	3	W
Operating Junction and Storage Temperature Range	$T_J, T_{STG}$	-65 to 150	$^\circ\text{C}$

### THERMAL CHARACTERISTICS

Thermal Resistance, Junction-to-Ambient <sup>a</sup>	$R_{\theta JA}$	42	$^\circ\text{C/W}$
--	-----------------	----	--------------------

# CEA3055L

## ELECTRICAL CHARACTERISTICS (TA=25°C unless otherwise noted)

Parameter	Symbol	Condition	Min	Typ <sup>c</sup>	Max	Unit
<b>OFF CHARACTERISTICS</b>						
Drain-Source Breakdown Voltage	BV <sub>DSS</sub>	V <sub>GS</sub> = 0V, I <sub>D</sub> =250μA	60	65		V
Zero Gate Voltage Drain Current	I <sub>DSS</sub>	V <sub>DS</sub> =60V, V <sub>GS</sub> =0V			1	μA
Gate-Body Leakage	I <sub>GSS</sub>	V <sub>GS</sub> =±20V, V <sub>DS</sub> =0V			±100	nA
<b>ON CHARACTERISTICS<sup>b</sup></b>						
Gate Threshold Voltage	V <sub>GS(th)</sub>	V <sub>DS</sub> =V <sub>GS</sub> , I <sub>D</sub> =250μA	1	1.27	2	V
Drain-Source On-State Resistance	R <sub>DS(ON)</sub>	V <sub>GS</sub> =10V, I <sub>D</sub> =3.9A		63	100	mΩ
		V <sub>GS</sub> =4.5V, I <sub>D</sub> =3.7A		83	120	mΩ
On-State Drain Current	I <sub>D(ON)</sub>	V <sub>DS</sub> =10V, V <sub>GS</sub> =5V	10			A
Forward Transconductance	g <sub>FS</sub>	V <sub>DS</sub> =5V, I <sub>D</sub> =3.7A	3	9		S
<b>DYNAMIC CHARACTERISTICS<sup>c</sup></b>						
Input Capacitance	C <sub>ISS</sub>	V <sub>DS</sub> = 25V, V <sub>GS</sub> = 0V f = 1.0MHz		615	800	pF
Output Capacitance	C <sub>OSS</sub>			190	250	pF
Reverse Transfer Capacitance	C <sub>RSS</sub>			45	60	pF
<b>SWITCHING CHARACTERISTICS<sup>c</sup></b>						
Turn-On Delay Time	t <sub>D(ON)</sub>	V <sub>DD</sub> = 25V, I <sub>D</sub> = 1A, V <sub>GEN</sub> = 10V, R <sub>GEN</sub> = 6Ω		15	20	ns
Rise Time	t <sub>r</sub>			18	20	ns
Turn-Off Delay Time	t <sub>D(OFF)</sub>			40	50	ns
Fall time	t <sub>f</sub>			16	20	ns
Total Gate Charge	Q <sub>g</sub>	V <sub>DS</sub> = 40V, I <sub>D</sub> = 3.7A, V <sub>GS</sub> = 10V		9	12	nC
Gate-Source Charge	Q <sub>gs</sub>			2		nC
Gate-Drain Charge	Q <sub>gd</sub>			6		nC

# CEA3055L

## ELECTRICAL CHARACTERISTICS ( $T_A=25^\circ\text{C}$ unless otherwise noted)

Parameter	Symbol	Condition	Min	Typ <sup>c</sup>	Max	Unit
<b>DRAIN-SOURCE DIODE CHARACTERISTICS<sup>b</sup></b>						
Diode Forward Voltage	$V_{SD}$	$V_{GS} = 0V, I_S = 1.5A$		0.78	1.5	V

### Notes

- a. Surface Mounted on FR4 Board,  $t \leq 10\text{sec}$ .
- b. Pulse Test: Pulse Width  $\leq 300 \mu\text{s}$ , Duty Cycle  $\leq 2\%$ .
- c. Guaranteed by design, not subject to production testing.

9

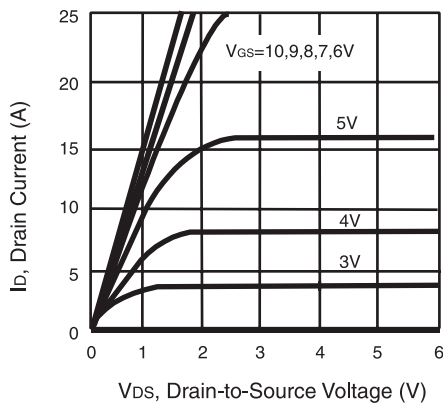

Figure 1. Output Characteristics

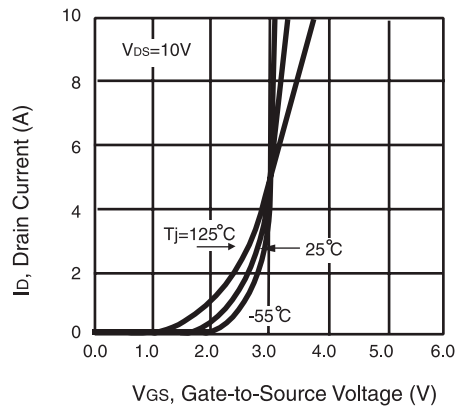

Figure 2. Transfer Characteristics

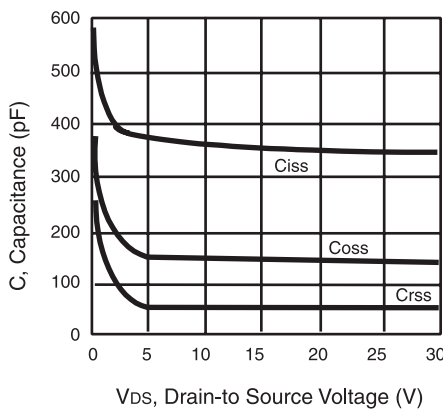

Figure 3. Capacitance

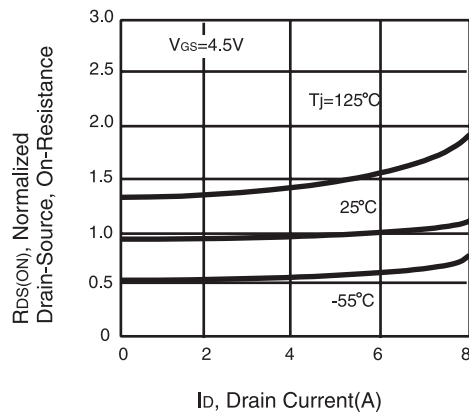
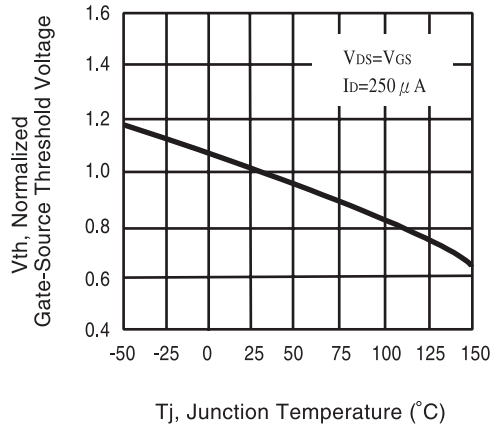
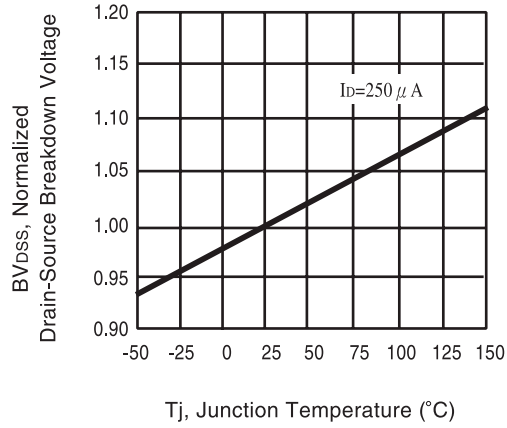

Figure 4. On-Resistance Variation with Drain Current and Temperature

# CEA3055L



**Figure 5. Gate Threshold Variation with Temperature**



**Figure 6. Breakdown Voltage Variation with Temperature**

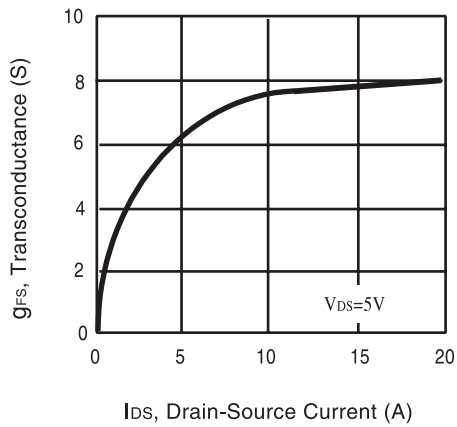

**Figure 7. Transconductance Variation with Drain Current**

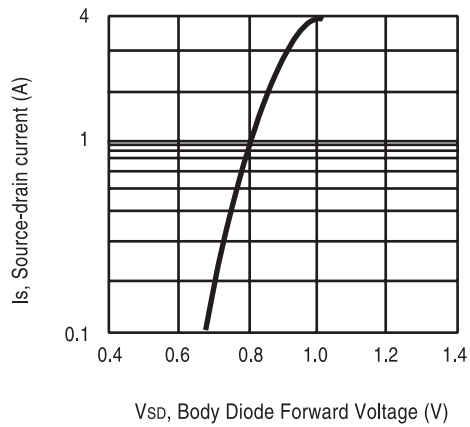

**Figure 8. Body Diode Forward Voltage Variation with Source Current**

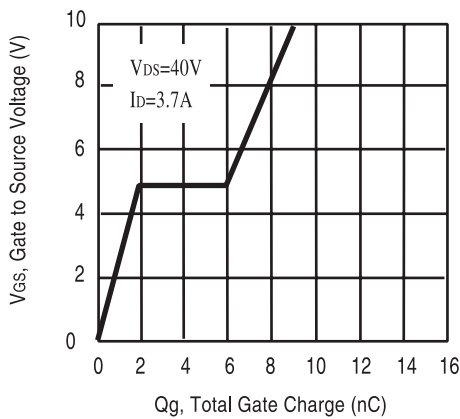

**Figure 9. Gate Charge**

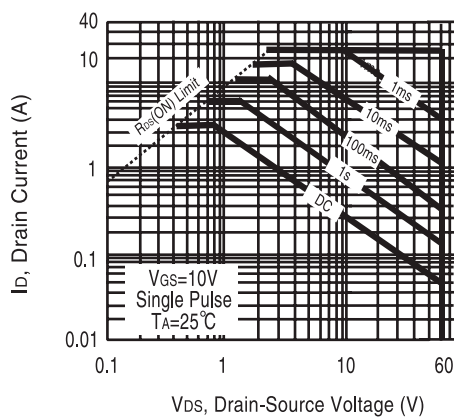

**Figure 10. Maximum Safe Operating Area**

9

# CEA3055L

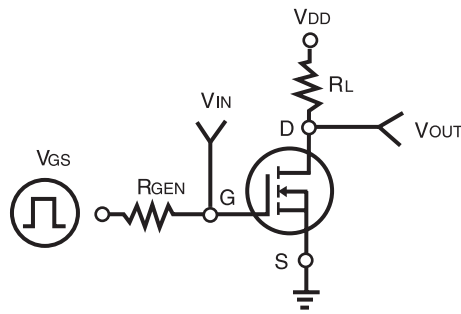

Figure 11. Switching Test Circuit

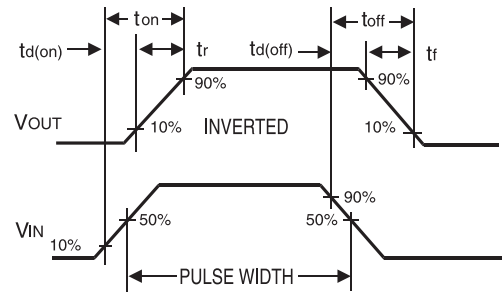

Figure 12. Switching Waveforms

9

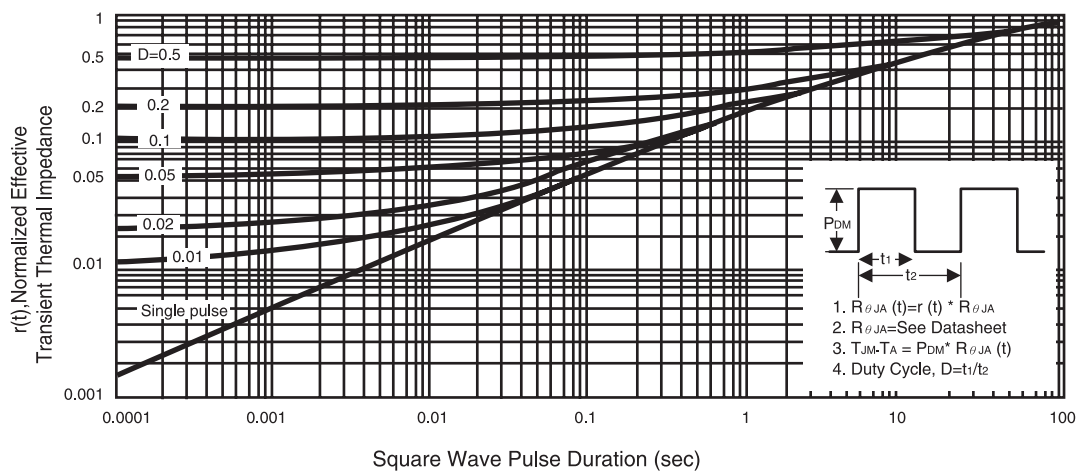

Figure 13. Normalized Thermal Transient Impedance Curve