

KLH1529/KLH1529A

HIGH VOLTAGE, PHOTO MOS RELAY

COSMO

FEATURES

- Photo Mos Relay and Optocoupler in One Package
- Control 350VAC or DC Voltage
- Switch 130mA Loads
- LED control Current, 5mA
- Low ON-Resistance
- $dv/dt, >500V/ms$
- Isolation Test Voltage, 3750VACrms

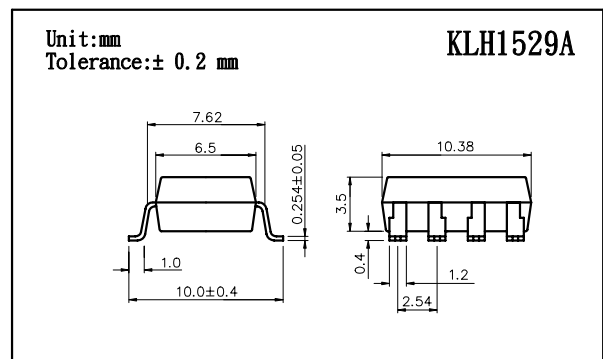
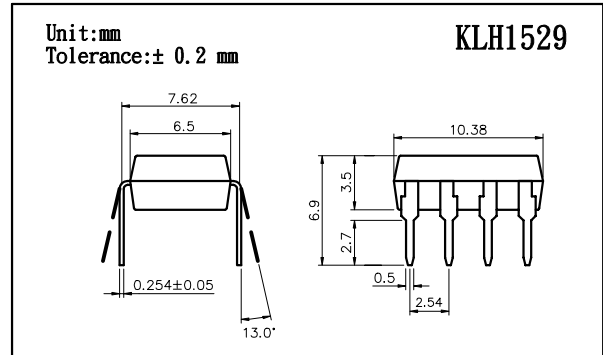

Absolute Maximum Ratings(Ta=25°C)

Emitter(Input)

Reverse Voltage	5.0V
Continuous Forward Current	50mA
Peak Forward Current	1A
Power Dissipation	100mW
Derate Linearly from 25°C	1.3mW/°C

Detector(Output)

Output Breakdown Voltage	± 350V
Continuous Load Current	± 130mA
Power Dissipation	500mW

General Characteristics

Isolation Test Voltage	3750VACrms
Isolation Resistance $V_{io}=500V, T_a=25°C$	$\geq 10^{10} \Omega$
Total Power Dissipation	550mW
Derate Linearly from 25°C	2.5mW/°C
Storage Temperature Range	-40°C to +125°C
Operating Temperature Range	-30°C to +85°C
Junction Temperature	100°C
Soldering Temperature, 2mm from case, 10 sec	260°C

● Turn on/Turn off time

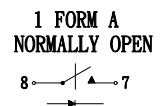
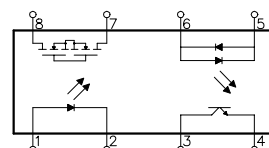
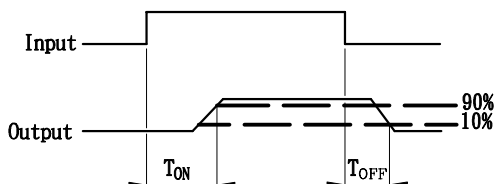

KLH1529/KLH1529A

HIGH VOLTAGE, PHOTO MOS RELAY

Characterisitcs

(Ta=25°C)

Description	Symbol	Min.	Typ.	Max.	Unit	Test Condition
Emitter(Input)						
Forward Voltage	VF		1.2	1.5	V	IF=10mA
Operation Input Current	IFON			5	mA	VL=± 20V, IL=100mA t=10mS
Recovery Input Current	IFOFF	0.2			mA	VL=± 20V, IL<=5uA
Detector (output)						
Output Breakdown Voltage	VB	350			V	IB=50uA
Output Off-State Leakage	IT(OFF)		0.2	1	uA	VT=100V, IF=0mA
I/O Capacitance	CISO		6		pF	IF=0, f=1MHz
ON Resistance	RON		20	30	Ω	IL=100mA, IF=10mA
Turn-on Time	TON		0.3	1.0	ms	IF=10mA, VL=± 20V
Turn-off Time	TOFF		0.7	1.5	ms	t=10ms, IL=± 100mA

Mos Relay Schematic and Wiring Diagrams

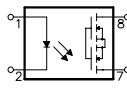
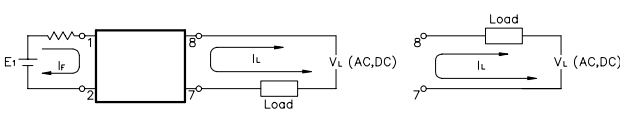
Type	Schematic	Output configuration	Load	Con- nection	Wiring Diagrams
KLH1529 & KLH1529A		1a	AC/DC	-	

DATA CURVE

Load current vs. ambient temperature
Allowable ambient temperature:
-40°C to +85°C

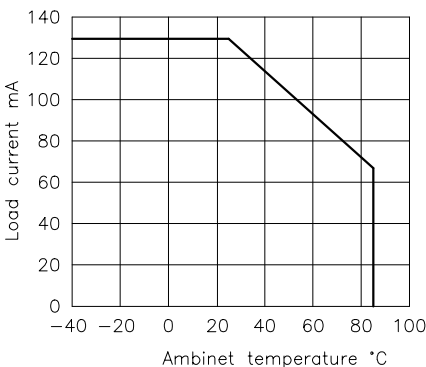

On resistance vs. ambient temperature
Across terminals 7 and 8 pin
LED current: 5mA
Continuouse load current: 130mA(DC)

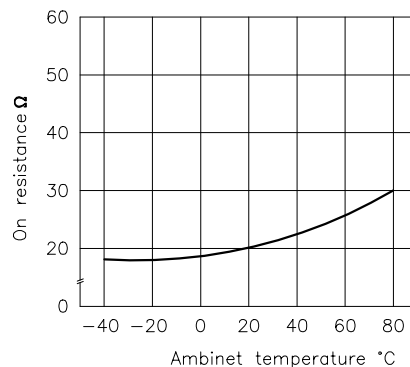

Trun on time vs. ambient temperature
Load voltage 350V(DC)
LED current: 5mA
Continuouse load current: 130mA(DC)

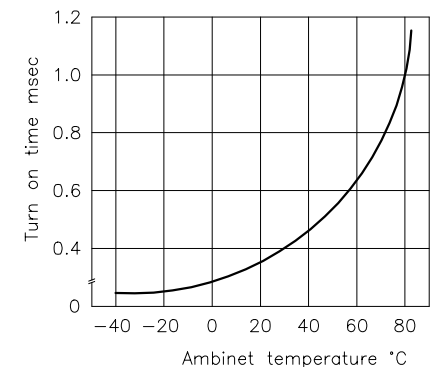

KLH1529/KLH1529A

HIGH VOLTAGE, PHOTO MOS RELAY

KLH1529/KLH1529A

Turn off time vs. ambient temperature
LED current: 5mA
Load voltage: 350V(DC)
Continuous load current: 130mA(DC)

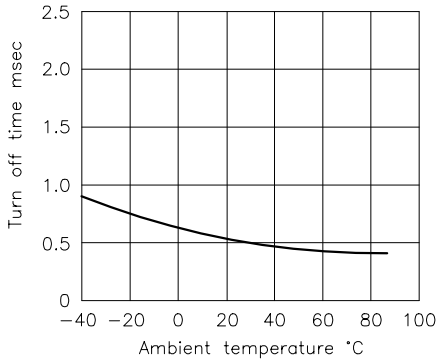

LED operate vs. ambient temperature
Load voltage: 350V(DC)
Continuous load current: 130mA(DC)

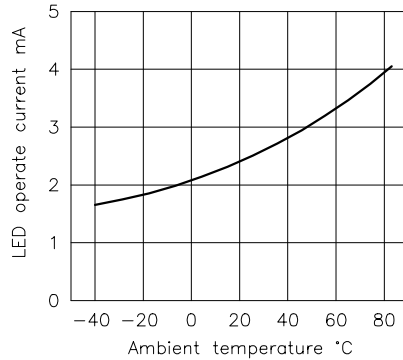

LED turn off current vs. ambient temperature
Load voltage: 350V(DC)
Continuous load current: 130mA(DC)

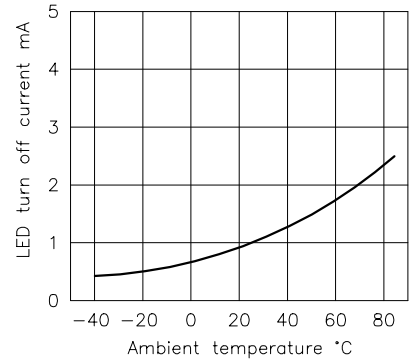

LED dropout voltage vs. ambient temperature
LED current: 5 to 50mA

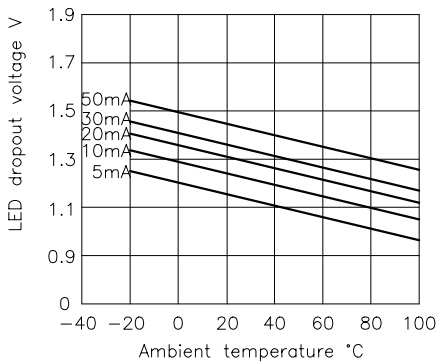

Voltage vs. current characteristics of output at MOS FET portion
Measured portion: across terminal 7 and 8 pin
Ambient temperature: 25°C

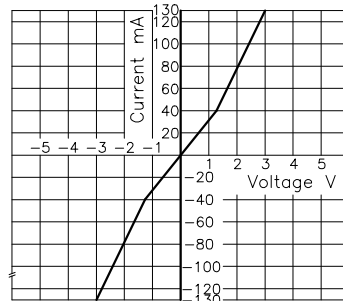

Off state leakage current
Across terminals 7 and 8 pin
Ambient temperature: 25°C

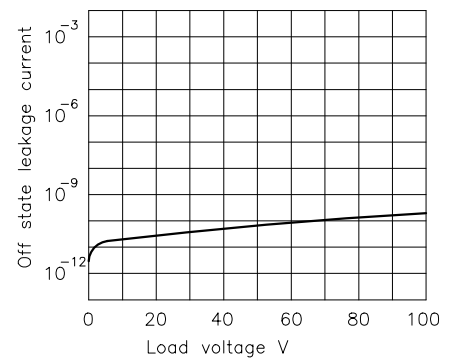

LED forward current vs. turn on time
Across terminals 7 and 8 pin
load voltage: 350V(DC); Continuous load current: 130mA(DC); Ambient temperature: 25°C

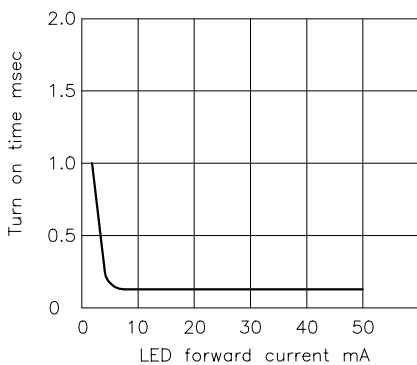

LED forward current vs. turn off time
Across terminals 7 and 8 pin
load voltage: 350V(DC); Continuous load current: 130mA(DC); Ambient temperature: 25°C

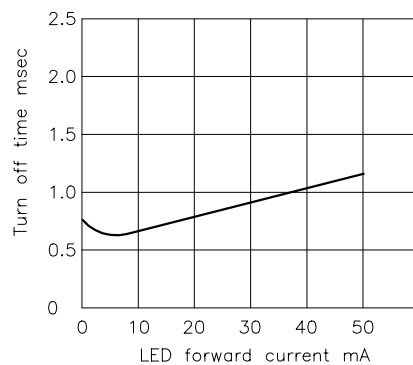

Applied voltage vs. output capacitance
Across terminals 7 and 8 pin
Frequency: 1MHz; Ambient temperature 25°C

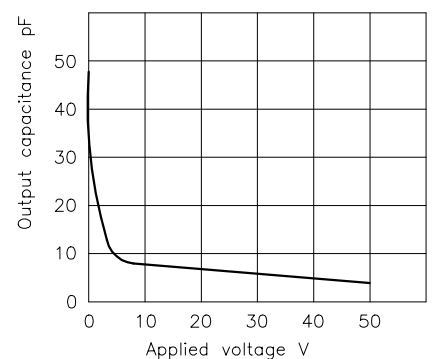

KLH1529/KLH1529A

HIGH VOLTAGE, PHOTO CMOS RELAY

KLH1529/KLH1529A

• Absolute Maximum Ratings

(Ta=25°C)

	Parameter	Symbol	Rating	Unit
Input	Forward current	IF	± 50	mA
	Peak forward current	IFM	± 1	A
	Power dissipation	PD	70	mW
Output	Collector-emitter voltage	VCE0	60	V
	Emitter-collector voltage	VECO	6	V
	Collector current	Ic	50	mA
	Collector power dissipation	Pc	150	mW
	Total power dissipation	Ptot	200	mW
	Isolation voltage 1 minute	Viso	1500	Vrms
	Operating temperature	Topr	-30 to +100	° C
	Storage temperature	Tstg	-55 to +125	° C
	Soldering temperature 10 second	Tsol	260	° C

• Electro-optical Characteristics

(Ta=25°C)

	Parameter	Symbol	Conditions	MIN.	TYP.	MAX.	Unit
Input	Forward voltage	VF	IF=± 20mA	-	1.2	1.4	V
	Peak forward voltage	VFM	IFM=± 0.5A	-	-	3.5	V
	Terminal capacitance	Ct	V=0, f=1kHz	-	30	-	pF
Output	Collector dark current	ICE0	VCE=20V, IF=0	-	-	0.1	uA
Transfer characteristics	Current transfer ratio	CTR	IF=± 1mA, VCE=5V	30	100	-	%
	Collector-emitter saturation voltage	VCE(sat)	IF=± 20mA, IC=1mA	-	0.1	0.3	V
	Isolation resistance	Riso	DC500V	5x10 ¹⁰	10 ¹¹	-	ohm
	Floating capacitance	Cf	V=0, f=1MHz	-	0.6	1.0	pF
	Cut-off frequency	fc	VCC=5V, IC=2mA, RL=100ohm	-	80	-	kHz
	Response time (Rise)	tr	VCC=2V, IC=2mA, RL=100ohm	-	5	20	us
	Response time (Fall)	tf		-	4	20	us

Fig. 1 Current Transfer Ratio vs. Forward Current

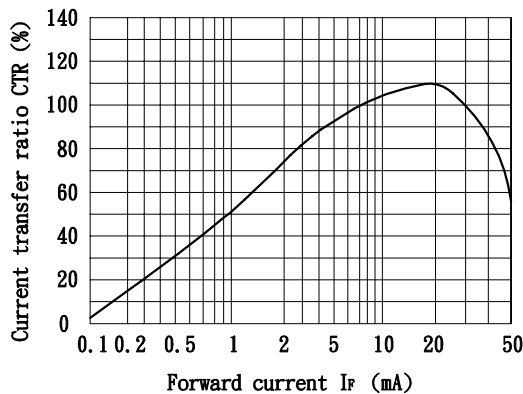
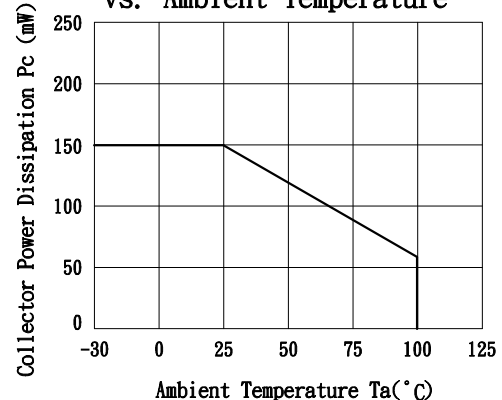

Fig. 2 Collector Power Dissipation vs. Ambient Temperature



KLH1529/KLH1529A

HIGH VOLTAGE, PHOTO MOS RELAY

KLH1529/KLH1529A

Fig. 3 Collector Dark Current vs. Ambient Temperature

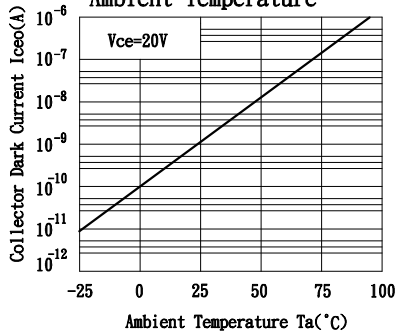

Fig. 4 Forward Current vs. Ambient Temperature

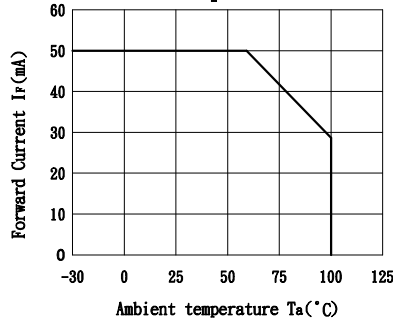

Fig. 5 Forward Current vs. Forward Voltage

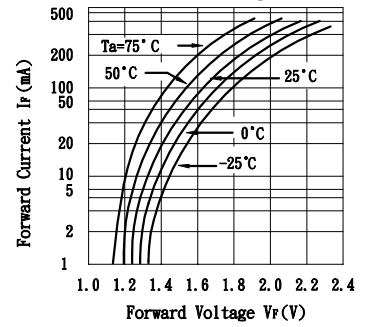

Fig. 6 Collector Current vs. Collector-emitter Voltage

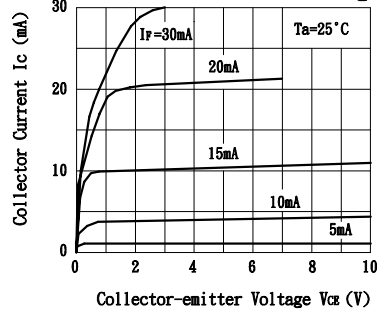

Fig. 7 Relative Current Transfer Ratio vs. Ambient Temperature

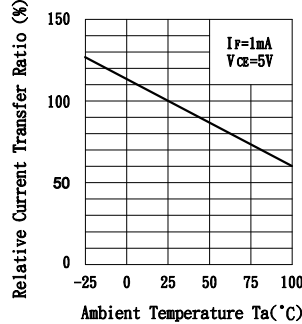

Fig. 8 Collector-emitter Saturation Voltage vs. Ambient Temperature

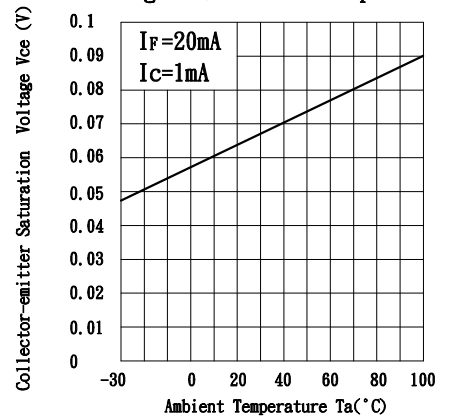

Fig. 9 Collector-emitter Saturation Voltage vs. Forward Current

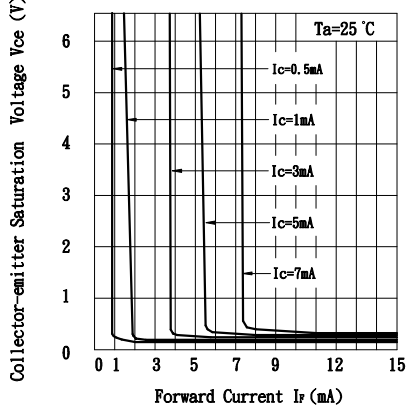

Fig. 10 Response Time vs. Load Resistance

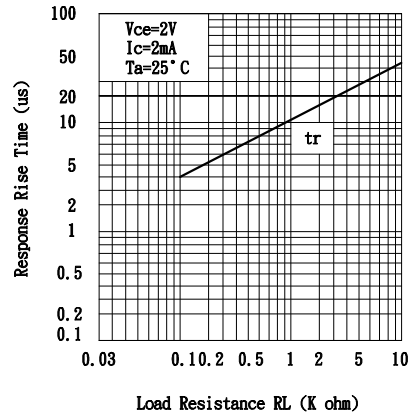

Fig. 11 Response Time vs. Load Resistance

