



	LAA120L	Units
Load Voltage	250	V
Load Current	170	mA
Max R <sub>ON</sub>	20	Ω

### Description

LAA120L is a 250V, 170mA, 20Ω 2-Form-A relay. It features enhanced peak load current handling capability and improved on-resistance. Current limiting version is available ("L" suffix, see specification for variations in performance).

### Features

- Small 8 Pin DIP Package
- Low Drive Power Requirements (TTL/CMOS Compatible)
- No Moving Parts
- High Reliability
- Arc-Free With No Snubbing Circuits
- 3750V<sub>RMS</sub> Input/Output Isolation
- FCC Compatible
- VDE Compatible
- No EMI/RFI Generation
- Machine Insertable, Wave Solderable
- Current Limiting, Surface Mount and Tape & Reel Versions Available

### Applications

- Telecommunications
  - Telecom Switching
  - Tip/Ring Circuits
  - Modem Switching (Laptop, Notebook, Pocket Size)
  - Hookswitch
  - Dial Pulsing
  - Ground Start
  - Ringer Injection
- Instrumentation
  - Multiplexers
  - Data Acquisition
  - Electronic Switching
  - I/O Subsystems
  - Meters (Watt-Hour, Water, Gas)
- Medical Equipment-Patient/Equipment Isolation
- Security
- Aerospace
- Industrial Controls

### Approvals

- UL Recognized: File Number E76270
- CSA Certified: File Number LR 43639-10
- BSI Certified to:
  - BS EN 60950:1992 (BS7002:1992)  
Certificate #: 7344
  - BS EN 41003:1993  
Certificate #: 7344

### Ordering Information

Part #	Description
LAA120L	8 Pin DIP (50/Tube)
LAA120PL	8 Pin Flatpack (50/Tube)
LAA120PLTR	8 Pin Flatpack (1000/Reel)
LAA120LS	8 Pin Surface Mount (50/Tube)
LAA120LSTR	8 Pin Surface Mount (1000/Reel)

### Pin Configuration

#### LAA120L Pinout

AC/DC Configuration

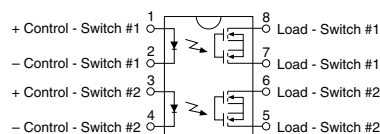

#### Switching Characteristics of Normally Open (Form A) Devices

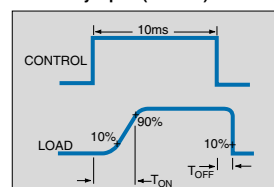

### Absolute Maximum Ratings (@ 25° C)

Parameter	Min	Typ	Max	Units
Input Power Dissipation	-	-	150 <sup>1</sup>	mW
Input Control Current	-	-	50	mA
Peak (10ms)	-	-	1	A
Reverse Input Voltage	-	-	5	V
Total Power Dissipation	-	-	800 <sup>2</sup>	mW
Isolation Voltage				
Input to Output	3750	-	-	V <sub>RMS</sub>
Operational Temperature	-40	-	+85	°C
Storage Temperature	-40	-	+125	°C
Soldering Temperature				
DIP Package	-	-	+260	°C
Flatpack/Surface Mount Package	-	-	+220	°C
(10 Seconds Max.)				

*Absolute Maximum Ratings are stress ratings. Stresses in excess of these ratings can cause permanent damage to the device. Functional operation of the device at these or any other conditions beyond those indicated in the operational sections of this data sheet is not implied. Exposure of the device to the absolute maximum ratings for an extended period may degrade the device and effect its reliability.*

<sup>1</sup> Derate Linearly 1.33 mw/°C

<sup>2</sup> Derate Linearly 6.67 mw/°C

### Electrical Characteristics

Parameter	Conditions	Symbol	Min	Typ	Max	Units
<b>Output Characteristics @ 25°C</b>						
Load Voltage (Peak)	-	V <sub>L</sub>	-	-	250	V
Load Current (Continuous)	-	I <sub>L</sub>	-	-	150	mA
AC/DC Configuration	-	I <sub>L</sub>	-	-	150	mA
Peak Load Current	10ms max	I <sub>LPK</sub>	-	-	-	mA
On-Resistance						
AC/DC Configuration	I <sub>L</sub> =Load Current	R <sub>ON</sub>	-	12	25	Ω
Off-State Leakage Current	V <sub>L</sub> =250V	I <sub>LEAK</sub>	-	-	1	μA
Switching Speeds						
Turn-On	I <sub>F</sub> =5mA, V <sub>L</sub> =10V	T <sub>ON</sub>	-	-	5	ms
Turn-Off	I <sub>F</sub> =5mA, V <sub>L</sub> =10V	T <sub>OFF</sub>	-	-	5	ms
Output Capacitance	50V; f=1MHz	C <sub>OUT</sub>	-	50	-	pF
Load Current Limiting		I <sub>CL</sub>	190	235	280	mA
<b>Input Characteristics @ 25°C</b>						
Input Control Current	I <sub>L</sub> =Load Current	I <sub>F</sub>	5	-	50	mA
Input Dropout Current	-	-	0.4	0.7	-	mA
Input Voltage Drop	I <sub>F</sub> =5mA	V <sub>F</sub>	0.9	1.2	1.4	V
Reverse Input Voltage	-	V <sub>R</sub>	-	-	5	V
Reverse Input Current	V <sub>r</sub> =5V	I <sub>R</sub>	-	-	10	μA
Input to Output Capacitance	-	C <sub>I/O</sub>	-	3	-	pF
Input to Output Isolation	-	V <sub>I/O</sub>	3750	-	-	V <sub>RMS</sub> <sup>3</sup>

PERFORMANCE DATA\*

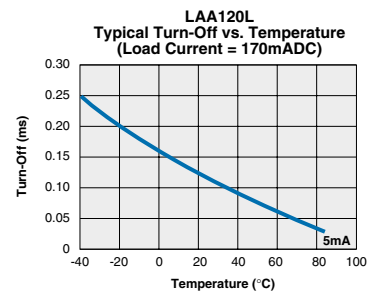
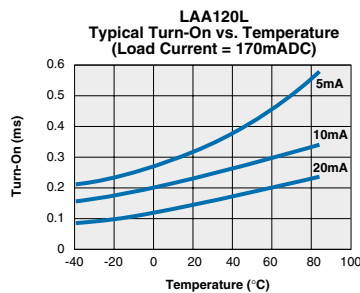
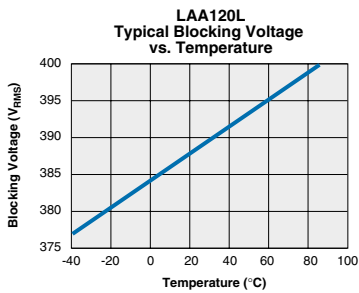
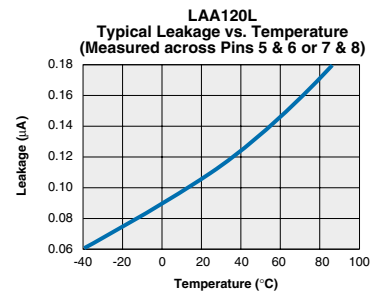
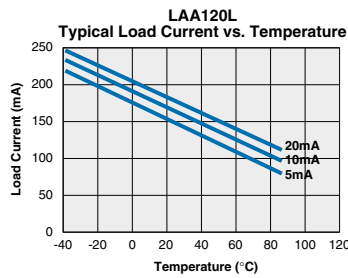
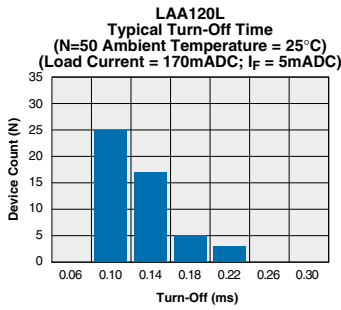
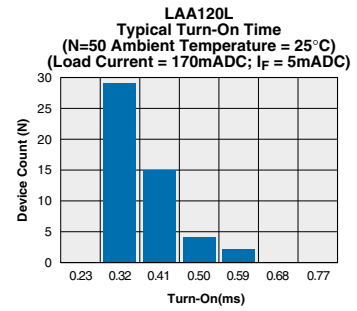
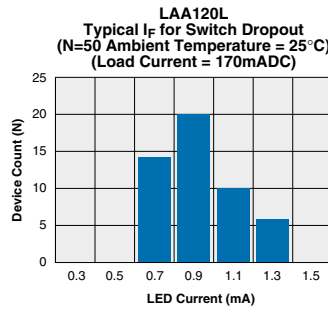
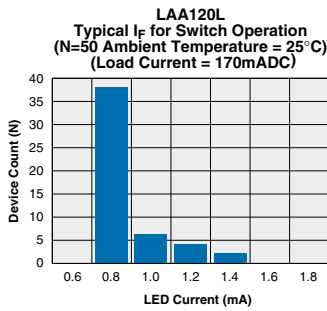
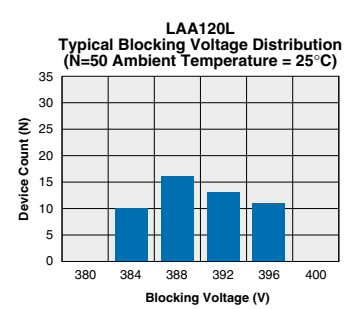
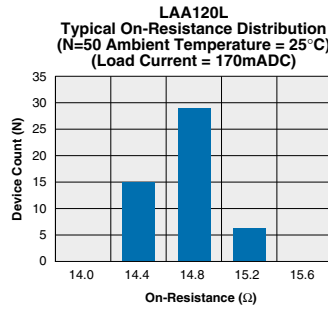
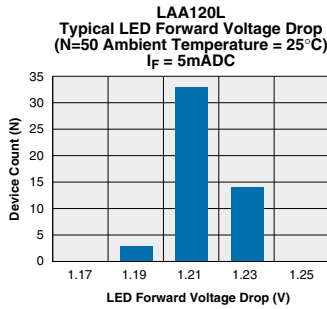

The Performance data shown in the graphs above is typical of device performance. For guaranteed parameters not indicated in the written specifications, please contact our application department.

PERFORMANCE DATA\*

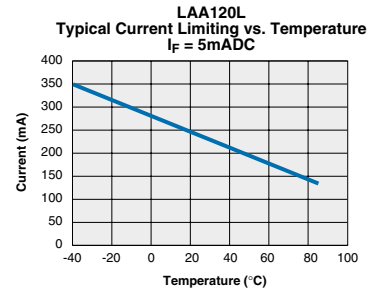
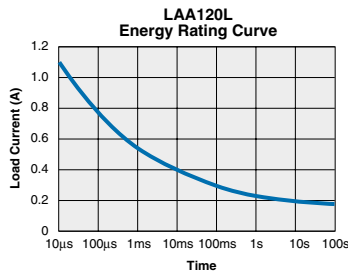
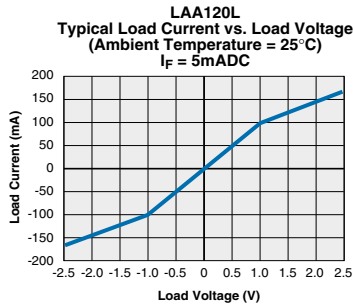
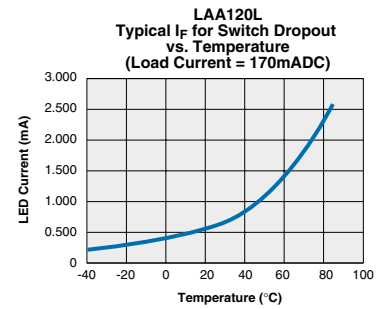
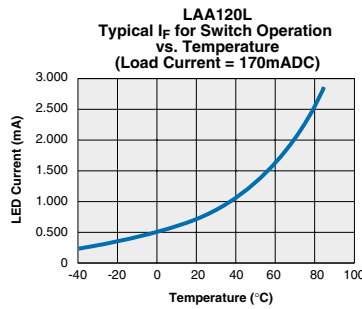
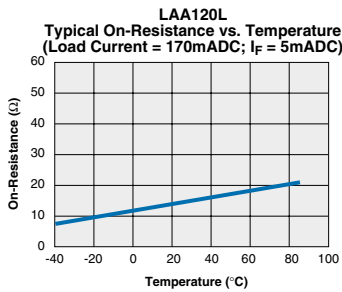
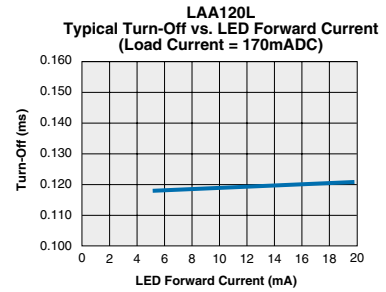
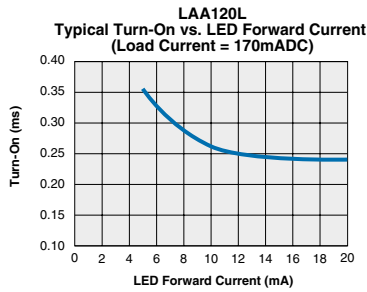
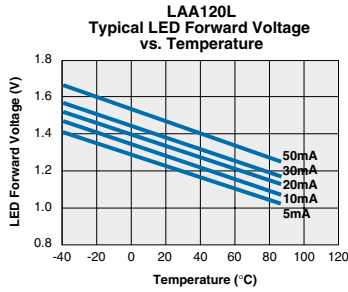

\*The Performance data shown in the graphs above is typical of device performance. For guaranteed parameters not indicated in the written specifications, please contact our application department.

### Mechanical Dimensions

**8 Pin DIP Through Hole (Standard)**

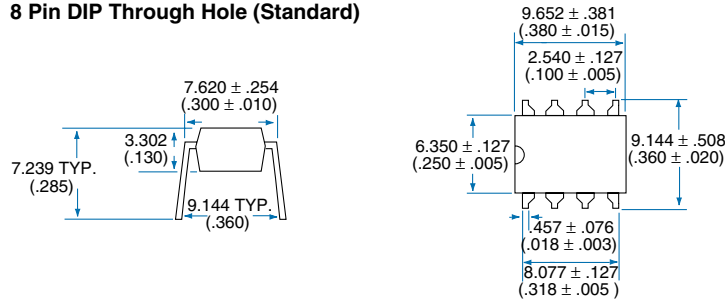

**PC Board Pattern (Top View)**

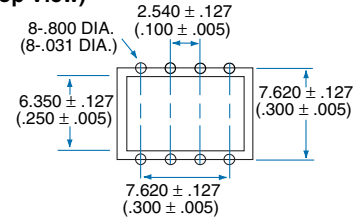

**8 Pin Flatpack ("P" Suffix)**

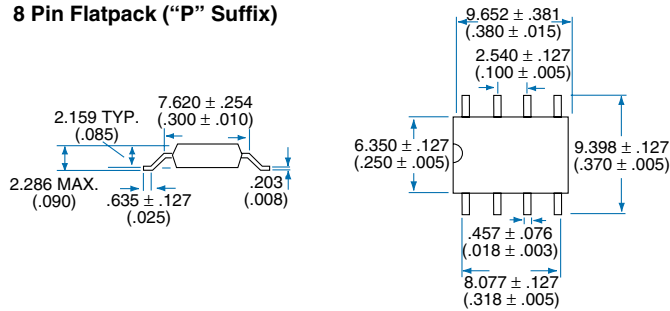

**PC Board Pattern (Top View)**

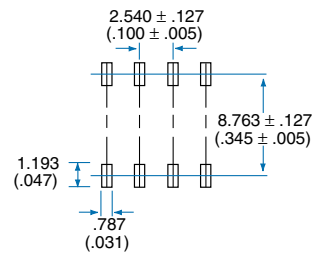

**8 Pin DIP Surface Mount ("S" Suffix)**

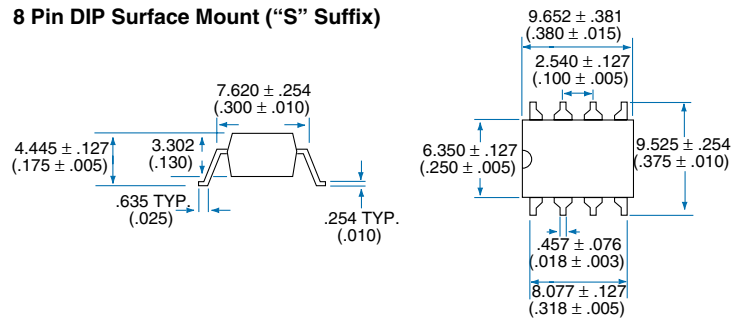

**PC Board Pattern (Top View)**

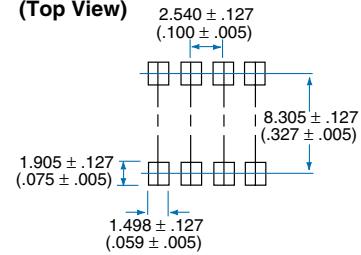

Dimensions  
 mm  
 (inches)



**CLARE LOCATIONS**

Clare Headquarters  
78 Cherry Hill Drive  
Beverly, MA 01915  
Tel: 1-978-524-6700  
Fax: 1-978-524-4900  
Toll Free: 1-800-27-CLARE

Clare Micronix Division  
145 Columbia  
Aliso Viejo, CA 92656-1490  
Tel: 1-949-831-4622  
Fax: 1-949-831-4628

**SALES OFFICES**

**AMERICAS**

**Americas Headquarters**

Clare  
78 Cherry Hill Drive  
Beverly, MA 01915  
Tel: 1-978-524-6700  
Fax: 1-978-524-4900  
Toll Free: 1-800-27-CLARE

**Eastern Region**

Clare  
P.O. Box 856  
Mahwah, NJ 07430  
Tel: 1-201-236-0101  
Fax: 1-201-236-8685  
Toll Free: 1-800-27-CLARE

**Central Region**

Clare Canada Ltd.  
3425 Harvester Road, Suite 202  
Burlington, Ontario L7N 3N1  
Tel: 1-905-333-9066  
Fax: 1-905-333-1824

**Western Region**

Clare  
1852 West 11th Street, #348  
Tracy, CA 95376  
Tel: 1-209-832-4367  
Fax: 1-209-832-4732  
Toll Free: 1-800-27-CLARE

**Canada**

Clare Canada Ltd.  
3425 Harvester Road, Suite 202  
Burlington, Ontario L7N 3N1  
Tel: 1-905-333-9066  
Fax: 1-905-333-1824

**EUROPE**

**European Headquarters**

CP Clare nv  
Bampslaan 17  
B-3500 Hasselt (Belgium)  
Tel: 32-11-300868  
Fax: 32-11-300890

**France**

Clare France Sales  
Lead Rep  
99 route de Versailles  
91160 Champlan  
France  
Tel: 33 1 69 79 93 50  
Fax: 33 1 69 79 93 59

**Germany**

Clare Germany Sales  
ActiveComp Electronic GmbH  
Mitterstrasse 12  
85077 Manching  
Germany  
Tel: 49 8459 3214 10  
Fax: 49 8459 3214 29

**Italy**

C.L.A.R.E.s.a.s.  
Via C. Colombo 10/A  
I-20066 Melzo (Milano)  
Tel: 39-02-95737160  
Fax: 39-02-95738829

**Sweden**

Clare Sales  
Comptronic AB  
Box 167  
S-16329 Spånga  
Tel: 46-862-10370  
Fax: 46-862-10371

**United Kingdom**

Clare UK Sales  
Marco Polo House  
Cook Way  
Bindon Road  
Taunton  
UK-Somerset TA2 6BG  
Tel: 44-1-823 352541  
Fax: 44-1-823 352797

**ASIA/PACIFIC**

**Asian Headquarters**

Clare  
Room N1016, Chia-Hsin, Bldg II,  
10F, No. 96, Sec. 2  
Chung Shan North Road  
Taipei, Taiwan R.O.C.  
Tel: 886-2-2523-6368  
Fax: 886-2-2523-6369

<http://www.clare.com>

---

*Clare cannot assume responsibility for use of any circuitry other than circuitry entirely embodied in this Clare product. No circuit patent licenses nor indemnity are expressed or implied. Clare reserves the right to change the specification and circuitry, without notice at any time. The products described in this document are not intended for use in medical implantation or other direct life support applications where malfunction may result in direct physical harm, injury or death to a person.*

---