



256K x 16 Static RAM

Features

- High speed
 - $t_{AA} = 15 \text{ ns}$
- Low active power
 - 1430 mW (max.)
- Low CMOS standby power (L version)
 - 2.75 mW (max.)
- 2.0V Data Retention (400 μW at 2.0V retention)
- Automatic power-down when deselected
- TTL-compatible inputs and outputs
- Easy memory expansion with $\overline{\text{CE}}$ and $\overline{\text{OE}}$ features

Functional Description

The CY7C1041 is a high-performance CMOS static RAM organized as 262,144 words by 16 bits.

Writing to the device is accomplished by taking Chip Enable ($\overline{\text{CE}}$) and Write Enable ($\overline{\text{WE}}$) inputs LOW. If Byte Low Enable ($\overline{\text{BLE}}$) is LOW, then data from I/O pins (I/O_0 through I/O_7), is

written into the location specified on the address pins (A_0 through A_{17}). If Byte High Enable ($\overline{\text{BHE}}$) is LOW, then data from I/O pins (I/O_8 through I/O_{15}) is written into the location specified on the address pins (A_0 through A_{17}).

Reading from the device is accomplished by taking Chip Enable ($\overline{\text{CE}}$) and Output Enable ($\overline{\text{OE}}$) LOW while forcing the Write Enable ($\overline{\text{WE}}$) HIGH. If Byte Low Enable ($\overline{\text{BLE}}$) is LOW, then data from the memory location specified by the address pins will appear on I/O_0 to I/O_7 . If Byte High Enable ($\overline{\text{BHE}}$) is LOW, then data from memory will appear on I/O_8 to I/O_{15} . See the truth table at the back of this data sheet for a complete description of read and write modes.

The input/output pins (I/O_0 through I/O_{15}) are placed in a high-impedance state when the device is deselected ($\overline{\text{CE}}$ HIGH), the outputs are disabled ($\overline{\text{OE}}$ HIGH), the $\overline{\text{BHE}}$ and $\overline{\text{BLE}}$ are disabled ($\overline{\text{BHE}}$, $\overline{\text{BLE}}$ HIGH), or during a write operation ($\overline{\text{CE}}$ LOW, and $\overline{\text{WE}}$ LOW).

The CY7C1041 is available in a standard 44-pin 400-mil-wide body width SOJ and 44-pin TSOP II package with center power and ground (revolutionary) pinout.

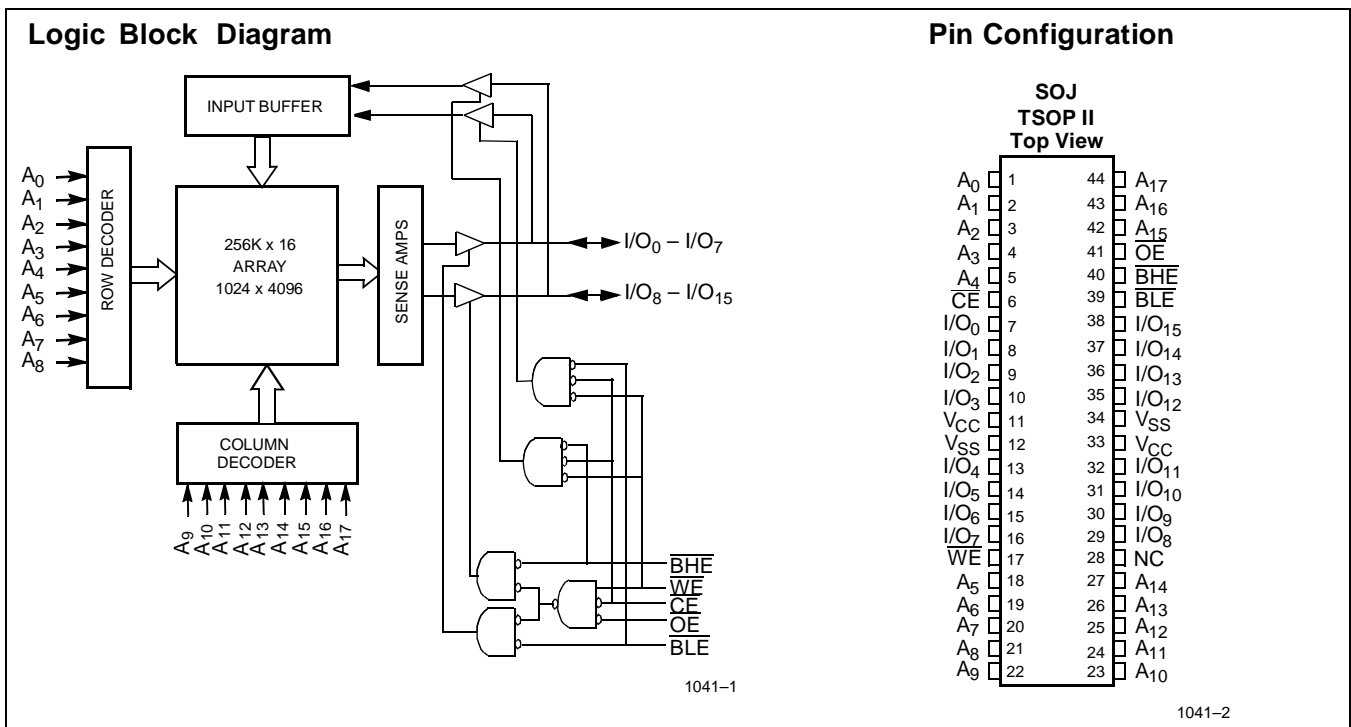

Selection Guide

		7C1041-12	7C1041-15	7C1041-17	7C1041-20	7C1041-25
Maximum Access Time (ns)		12	15	17	20	25
Maximum Operating Current (mA)		280	260	250	230	220
Maximum CMOS Standby Current (mA)	Com'l	3	3	3	3	3
	Com'l	L	0.5	0.5	0.5	0.5
	Ind'l		6	6	6	6

Shaded areas contain preliminary information.

Maximum Ratings

(Above which the useful life may be impaired. For user guidelines, not tested.)

Storage Temperature -65°C to +150°C

Ambient Temperature with Power Applied -55°C to +125°C

Supply Voltage on V_{CC} to Relative GND^[1] -0.5V to +7.0V

DC Voltage Applied to Outputs in High Z State^[1] -0.5V to $V_{CC} + 0.5V$

DC Input Voltage^[1] -0.5V to $V_{CC} + 0.5V$

Current into Outputs (LOW) 20 mA

Operating Range

Range	Ambient Temperature ^[2]	V_{CC}
Commercial	0°C to +70°C	5V ± 0.5
Industrial	-40°C to +85°C	

Electrical Characteristics Over the Operating Range

Parameter	Description	Test Conditions	7C1041-12		7C1041-15		7C1041-17		Unit	
			Min.	Max.	Min.	Max.	Min.	Max.		
V_{OH}	Output HIGH Voltage	$V_{CC} = \text{Min.}, I_{OH} = -4.0 \text{ mA}$	2.4		2.4		2.4		V	
V_{OL}	Output LOW Voltage	$V_{CC} = \text{Min.}, I_{OL} = 8.0 \text{ mA}$		0.4		0.4		0.4	V	
V_{IH}	Input HIGH Voltage		2.2	$V_{CC} + 0.5$	2.2	$V_{CC} + 0.5$	2.2	$V_{CC} + 0.5$	V	
V_{IL}	Input LOW Voltage ^[1]		-0.5	0.8	-0.5	0.8	-0.5	0.8	V	
I_{IX}	Input Load Current	$GND \leq V_I \leq V_{CC}$	-1	+1	-1	+1	-1	+1	µA	
I_{OZ}	Output Leakage Current	$GND \leq V_{OUT} \leq V_{CC}$, Output Disabled	-1	+1	-1	+1	-1	+1	µA	
I_{CC}	V_{CC} Operating Supply Current	$V_{CC} = \text{Max.}, f = f_{MAX} = 1/t_{RC}$		280		260		250	mA	
I_{SB1}	Automatic CE Power-Down Current —TTL Inputs	Max. V_{CC} , $\overline{CE} \geq V_{IH}$ $V_{IN} \geq V_{IH}$ or $V_{IN} \leq V_{IL}$, $f = f_{MAX}$		40		40		40	mA	
I_{SB2}	Automatic CE Power-Down Current —CMOS Inputs	Max. V_{CC} , $\overline{CE} \geq V_{CC} - 0.3V$, $V_{IN} \geq V_{CC} - 0.3V$, or $V_{IN} \leq 0.3V$, $f = 0$	Com'l			3		3	3	mA
			Com'l	L		0.5		0.5	0.5	mA
			Ind'l			6		6	6	6

Shaded areas contain preliminary information.

Notes:

- $V_{IL}(\text{min.}) = -2.0V$ for pulse durations of less than 20 ns.
- T_A is the case temperature.

Electrical Characteristics Over the Operating Range (continued)

Parameter	Description	Test Conditions	7C1041-20		7C1041-25		Unit	
			Min.	Max.	Min.	Max.		
V_{OH}	Output HIGH Voltage	$V_{CC} = \text{Min.}, I_{OH} = -4.0 \text{ mA}$	2.4		2.4		V	
V_{OL}	Output LOW Voltage	$V_{CC} = \text{Min.}, I_{OL} = 8.0 \text{ mA}$		0.4		0.4	V	
V_{IH}	Input HIGH Voltage		2.2	$V_{CC} + 0.5$	2.2	$V_{CC} + 0.5$	V	
V_{IL}	Input LOW Voltage ^[1]		-0.5	0.8	-0.5	0.8	V	
I_{IX}	Input Load Current	$GND \leq V_I \leq V_{CC}$	-1	+1	-1	+1	μA	
I_{OZ}	Output Leakage Current	$GND \leq V_{OUT} \leq V_{CC}$, Output Disabled	-1	+1	-1	+1	μA	
I_{CC}	V_{CC} Operating Supply Current	$V_{CC} = \text{Max.},$ $f = f_{MAX} = 1/t_{RC}$		230		220	mA	
I_{SB1}	Automatic CE Power-Down Current —TTL Inputs	Max. V_{CC} , $\overline{CE} \geq V_{IH}$ $V_{IN} \geq V_{IH}$ or $V_{IN} \leq V_{IL}$, $f = f_{MAX}$		40		40	mA	
I_{SB2}	Automatic CE Power-Down Current —CMOS Inputs	Max. V_{CC} , $\overline{CE} \geq V_{CC} - 0.3\text{V}$, $V_{IN} \geq V_{CC} - 0.3\text{V}$, or $V_{IN} \leq 0.3\text{V}$, $f = 0$	Com'l		3		3	mA
			Com'l L		0.5		0.5	mA
			Ind'l		6		6	mA

Capacitance^[3]

Parameter	Description	Test Conditions	Max.	Unit
C_{IN}	Input Capacitance	$T_A = 25^\circ\text{C}, f = 1 \text{ MHz},$ $V_{CC} = 5.0\text{V}$	8	pF
C_{OUT}	I/O Capacitance		8	pF

Note:

3. Tested initially and after any design or process changes that may affect these parameters.

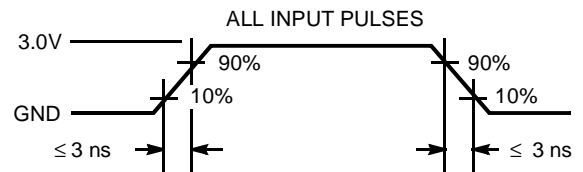
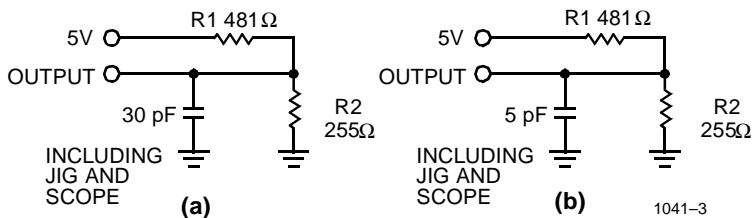
AC Test Loads and Waveforms

1041-4

Equivalent to: THÉVENIN EQUIVALENT

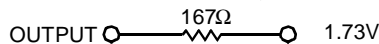

Switching Characteristics^[4] Over the Operating Range

Parameter	Description	7C1041-12		7C1041-15		7C1041-17		Unit
		Min.	Max.	Min.	Max.	Min.	Max.	
READ CYCLE								
t_{RC}	Read Cycle Time	12		15		17		ns
t_{AA}	Address to Data Valid		12		15		17	ns
t_{OHA}	Data Hold from Address Change	3		3		3		ns
t_{ACE}	\overline{CE} LOW to Data Valid		12		15		17	ns
t_{DOE}	\overline{OE} LOW to Data Valid		6		7		7	ns
t_{LZOE}	\overline{OE} LOW to Low Z	0		0		0		ns
t_{HZOE}	\overline{OE} HIGH to High Z ^[5, 6]		6		7		7	ns
t_{LZCE}	\overline{CE} LOW to Low Z ^[6]	3		3		3		ns
t_{HZCE}	\overline{CE} HIGH to High Z ^[5, 6]		6		7		7	ns
t_{PU}	\overline{CE} LOW to Power-Up	0		0		0		ns
t_{PD}	\overline{CE} HIGH to Power-Down		12		15		17	ns
t_{DBE}	Byte Enable to Data Valid		6		7		7	ns
t_{LZBE}	Byte Enable to Low Z	0		0		0		ns
t_{HZBE}	Byte Disable to High Z		6		7		7	ns
WRITE CYCLE^[7, 8]								
t_{WC}	Write Cycle Time	12		15		17		ns
t_{SCE}	\overline{CE} LOW to Write End	10		12		14		ns
t_{AW}	Address Set-Up to Write End	10		12		14		ns
t_{HA}	Address Hold from Write End	0		0		0		ns
t_{SA}	Address Set-Up to Write Start	0		0		0		ns
t_{PWE}	\overline{WE} Pulse Width	10		12		14		ns
t_{SD}	Data Set-Up to Write End	7		8		8		ns
t_{HD}	Data Hold from Write End	0		0		0		ns
t_{LZWE}	\overline{WE} HIGH to Low Z ^[6]	3		3		3		ns
t_{HZWE}	\overline{WE} LOW to High Z ^[5, 6]		6		7		7	ns
t_{BW}	Byte Enable to End of Write	10		12		12		ns

Shaded areas contain preliminary information.

Notes:

- Test conditions assume signal transition time of 3 ns or less, timing reference levels of 1.5V, input pulse levels of 0 to 3.0V, and output loading of the specified I_{OL}/I_{OH} and 30-pF load capacitance.
- t_{HZOE} , t_{HZCE} , and t_{HZWE} are specified with a load capacitance of 5 pF as in part (b) of AC Test Loads. Transition is measured ± 500 mV from steady-state voltage.
- At any given temperature and voltage condition, t_{HZCE} is less than t_{LZCE} , t_{HZOE} is less than t_{LZOE} , and t_{HZWE} is less than t_{LZWE} for any given device.
- The internal write time of the memory is defined by the overlap of \overline{CE} LOW, and \overline{WE} LOW. \overline{CE} and \overline{WE} must be LOW to initiate a write, and the transition of either of these signals can terminate the write. The input data set-up and hold timing should be referenced to the leading edge of the signal that terminates the write.
- The minimum write cycle time for Write Cycle No. 3 (\overline{WE} controlled, \overline{OE} LOW) is the sum of t_{HZWE} and t_{SD} .

Switching Characteristics^[4] Over the Operating Range (continued)

Parameter	Description	7C1041-20		7C1041-25		Unit
		Min.	Max.	Min.	Max.	
READ CYCLE						
t _{RC}	Read Cycle Time	20		25		ns
t _{AA}	Address to Data Valid		20		25	ns
t _{OHA}	Data Hold from Address Change	3		5		ns
t _{ACE}	\overline{CE} LOW to Data Valid		20		25	ns
t _{DOE}	\overline{OE} LOW to Data Valid		8		10	ns
t _{LZOE}	\overline{OE} LOW to Low Z	0		0		ns
t _{HZOE}	\overline{OE} HIGH to High Z ^[5, 6]		8		10	ns
t _{LZCE}	\overline{CE} LOW to Low Z ^[6]	3		5		ns
t _{HZCE}	\overline{CE} HIGH to High Z ^[5, 6]		8		10	ns
t _{PU}	\overline{CE} LOW to Power-Up	0		0		ns
t _{PD}	\overline{CE} HIGH to Power-Down		20		25	ns
t _{DBE}	Byte Enable to Data Valid		8		10	ns
t _{LZBE}	Byte Enable to Low Z	0		0		ns
t _{HZBE}	Byte Disable to High Z		8		10	ns
WRITE CYCLE^[7, 8]						
t _{WC}	Write Cycle Time	20		25		ns
t _{SCE}	\overline{CE} LOW to Write End	13		15		ns
t _{AW}	Address Set-Up to Write End	13		15		ns
t _{HA}	Address Hold from Write End	0		0		ns
t _{SA}	Address Set-Up to Write Start	0		0		ns
t _{PWE}	\overline{WE} Pulse Width	13		15		ns
t _{SD}	Data Set-Up to Write End	9		10		ns
t _{HD}	Data Hold from Write End	0		0		ns
t _{LZWE}	\overline{WE} HIGH to Low Z ^[6]	3		5		ns
t _{HZWE}	\overline{WE} LOW to High Z ^[5, 6]		8		10	ns
t _{BW}	Byte Enable to End of Write	13		15		ns

Data Retention Characteristics Over the Operating Range

Parameter	Description	Conditions ^[10]	Min.	Max.	Unit	
V _{DR}	V _{CC} for Data Retention		2.0		V	
I _{CCDR}	Data Retention Current	V _{CC} = V _{DR} = 2.0V, CE ≥ V _{CC} - 0.3V, V _{IN} ≥ V _{CC} - 0.3V or V _{IN} ≤ 0.3V			μA	
			Com'l L		200	μA
						μA
t _{CDR^[3]}	Chip Deselect to Data Retention Time		0		ns	
t _{R^[9]}	Operation Recovery Time		See Note 9			

Notes:

9. t_r ≤ 100 μs for all speeds.
10. No input may exceed V_{CC} + 0.5V.

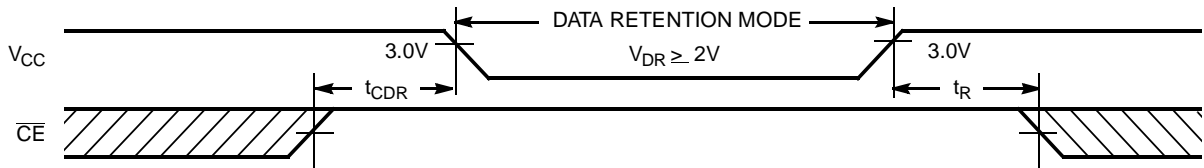
Data Retention Waveform

1041-5

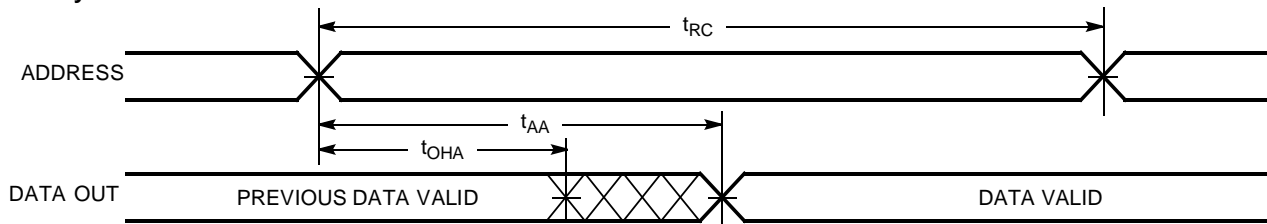
Switching Waveforms
Read Cycle No.1 ^[11, 12]

1041-6

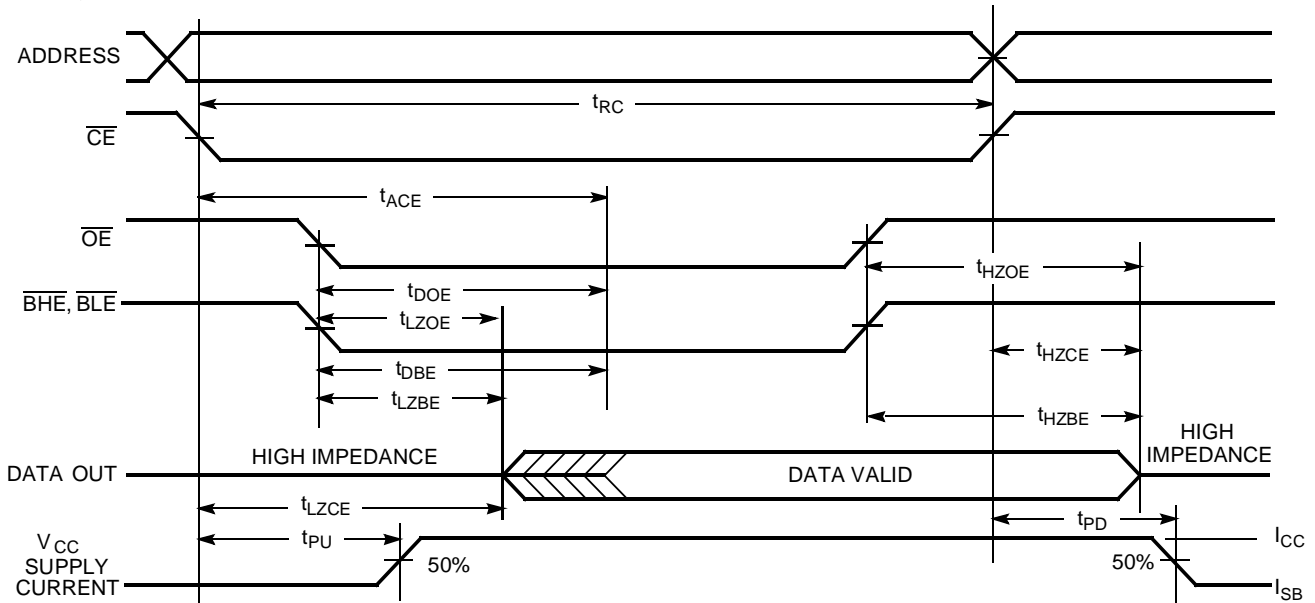
Read Cycle No.2 (\overline{OE} Controlled) ^[12, 13]

1041-7

Notes:

11. Device is continuously selected. \overline{OE} , \overline{CE} , \overline{BHE} , and/or \overline{BLE} = V_{IL} .
12. \overline{WE} is HIGH for read cycle.
13. Address valid prior to or coincident with \overline{CE} transition LOW.

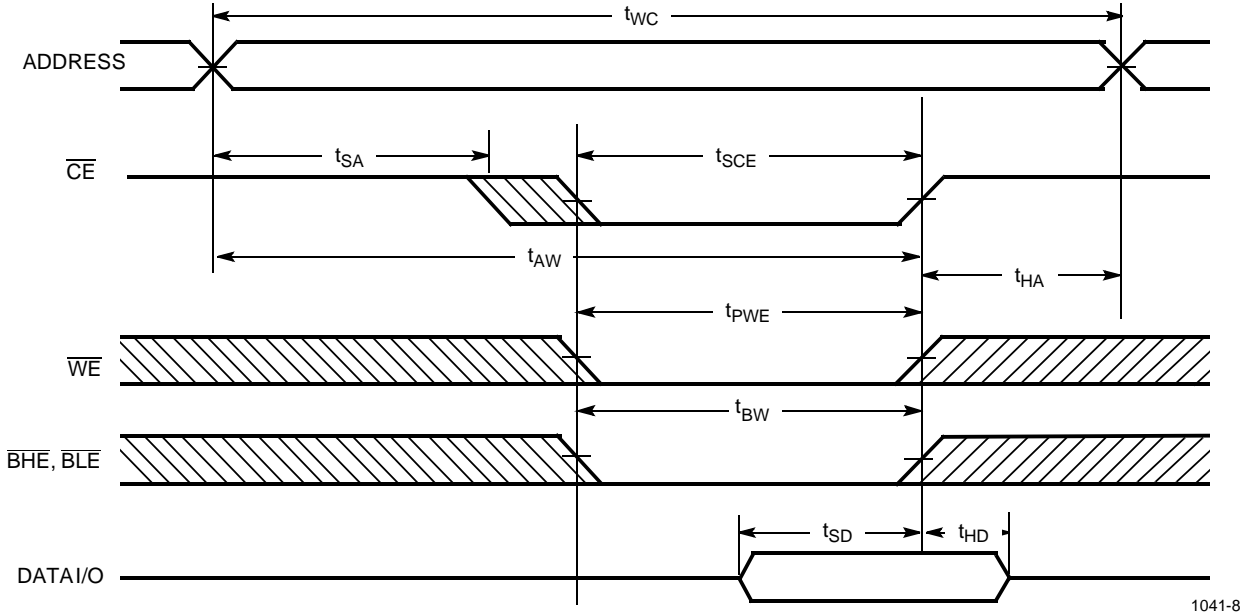
Switching Waveforms (continued)
Write Cycle No. 1 ($\overline{\text{CE}}$ Controlled) ^[14, 15]

1041-8

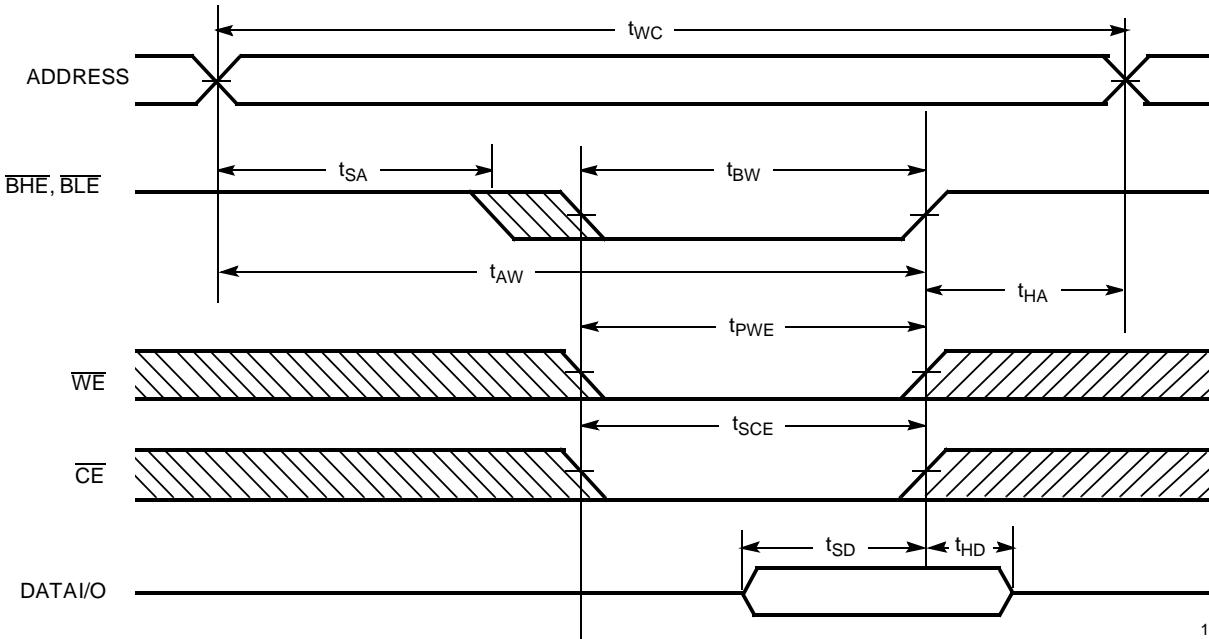
Write Cycle No. 2 ($\overline{\text{BLE}}$ or $\overline{\text{BHE}}$ Controlled)

1041-9

Notes:

14. Data I/O is high impedance if $\overline{\text{OE}}$ or $\overline{\text{BHE}}$ and/or $\overline{\text{BLE}} = V_{IH}$.
15. If $\overline{\text{CE}}$ goes HIGH simultaneously with $\overline{\text{WE}}$ going HIGH, the output remains in a high-impedance state.

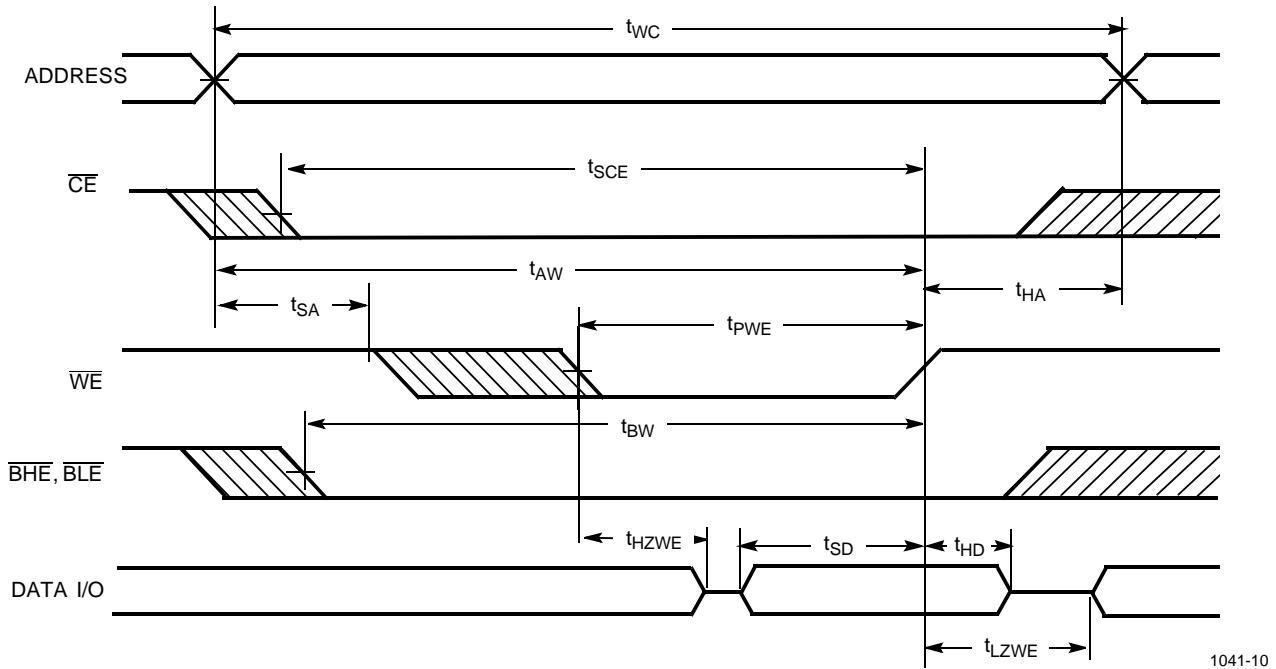
Switching Waveforms (continued)
Write Cycle No.3 (\overline{WE} Controlled, LOW)

1041-10

Truth Table

\overline{CE}	\overline{OE}	\overline{WE}	\overline{BLE}	\overline{BHE}	I/O ₀ -I/O ₇	I/O ₈ -I/O ₁₅	Mode	Power
H	X	X	X	X	High Z	High Z	Power Down	Standby (I_{SB})
L	L	H	L	L	Data Out	Data Out	Read All Bits	Active (I_{CC})
L	L	H	L	H	Data Out	High Z	Read Lower Bits Only	Active (I_{CC})
L	L	H	H	L	High Z	Data Out	Read Upper Bits Only	Active (I_{CC})
L	X	L	L	L	Data In	Data In	Write All Bits	Active (I_{CC})
L	X	L	L	H	Data In	High Z	Write Lower Bits Only	Active (I_{CC})
L	X	L	H	L	High Z	Data In	Write Upper Bits Only	Active (I_{CC})
L	H	H	X	X	High Z	High Z	Selected, Outputs Disabled	Active (I_{CC})

Ordering Information

Speed (ns)	Ordering Code	Package Name	Package Type	Operating Range
15	CY7C1041-15VC	V34	44-Lead (400-Mil) Molded SOJ	Commercial
	CY7C1041L-15VC	V34	44-Lead (400-Mil) Molded SOJ	
	CY7C1041-15ZC	Z44	44-Lead TSOP Type II	
	CY7C1041L-15ZC	Z44	44-Lead TSOP Type II	
17	CY7C1041-17VC	V34	44-Lead (400-Mil) Molded SOJ	
	CY7C1041L-17VC	V34	44-Lead (400-Mil) Molded SOJ	
	CY7C1041-17ZC	Z44	44-Lead TSOP Type II	
	CY7C1041L-17ZC	Z44	44-Lead TSOP Type II	
20	CY7C1041-20VC	V34	44-Lead (400-Mil) Molded SOJ	
	CY7C1041L-20VC	V34	44-Lead (400-Mil) Molded SOJ	
	CY7C1041-20ZC	Z44	44-Lead TSOP Type II	
	CY7C1041L-20ZC	Z44	44-Lead TSOP Type II	
25	CY7C1041-25VC	V34	44-Lead (400-Mil) Molded SOJ	
	CY7C1041L-25VC	V34	44-Lead (400-Mil) Molded SOJ	
	CY7C1041-25ZC	Z44	44-Lead TSOP Type II	
	CY7C1041L-25ZC	Z44	44-Lead TSOP Type II	
15	CY7C1041-15ZI	Z44	44-Lead TSOP Type II	Industrial
	CY7C1041-15VI	V34	44-Lead (400-Mil) Molded SOJ	
17	CY7C1041-17ZI	V34	44-Lead TSOP Type II	
	CY7C1041-17VI	Z44	44-Lead (400-Mil) Molded SOJ	
20	CY7C1041-20ZI	Z44	44-Lead TSOP Type II	
	CY7C1041-20VI	Z44	44-Lead (400-Mil) Molded SOJ	
25	CY7C1041-25ZI	Z44	44-Lead TSOP Type II	
	CY7C1041-25VI	Z44	44-Lead (400-Mil) Molded SOJ	

Document #: 38-00644-B

Package Diagrams

44-Lead (400-Mil) Molded SOJ V34

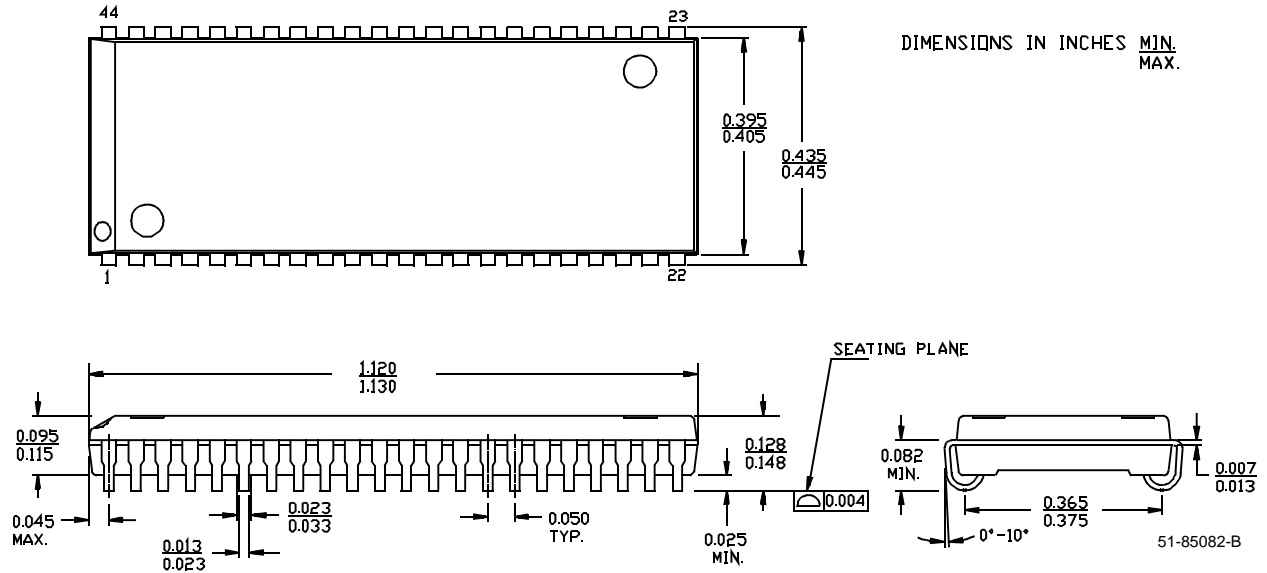

44-Pin TSOP II Z44

DIMENSION IN MM (INCH)
MAX
MIN.

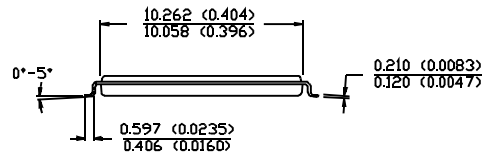
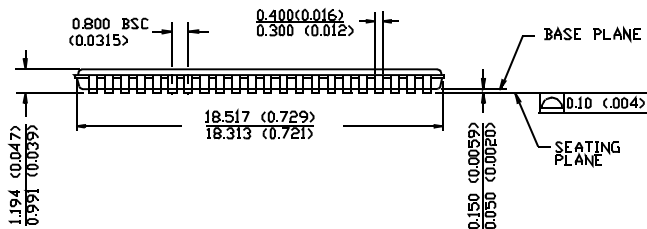
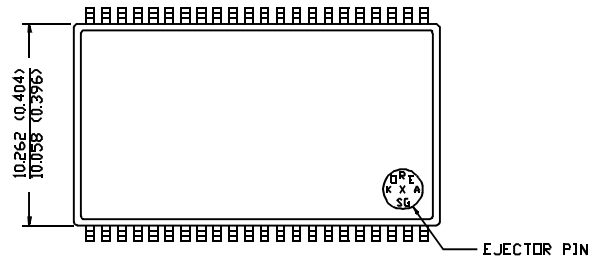
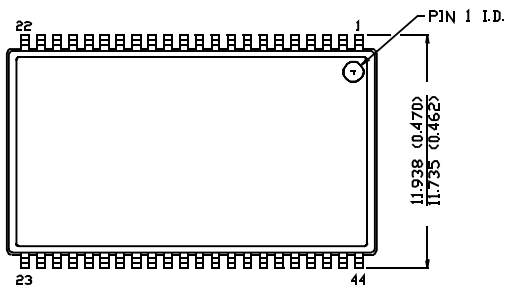

51-85087-A