

**SINGLE-CHIP 4-BIT MICOM.  
FOR REMOTE TRANSMITTER**

DMC6003-XXX is remote control transmitter which utilizes silicon gate CMOS technology. This housed in a 20 pin plastic molded DIP/SOP and enables transmission code output, multiple custom code output, and double push key output for easy fabrication of an 8 × 4 key matrix.

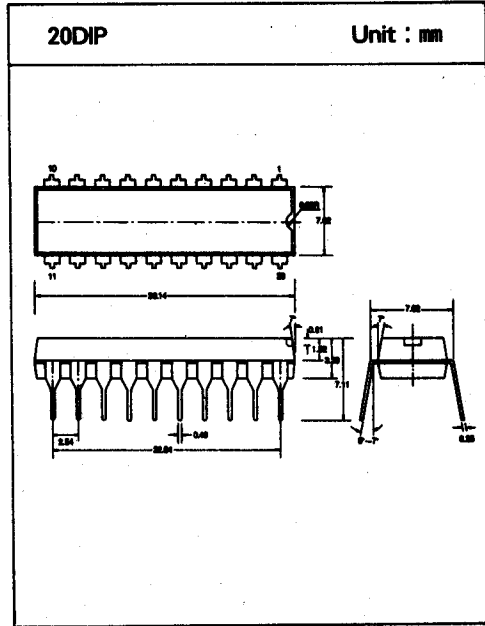

**FEATURES**

- Single power supply ..... 2.2~3.6V
- Power dissipation(stop mode,  $V_{DD}=3V$ ) ..... Less Than 3uW
- Number of basic instructions ..... 37
- Instruction execution time(one word instructions)
  - At 480kHz frequency ..... 16.67uS
  - At 455kHz frequency ..... 17.58uS
- Memory size ROM ..... 512Words × 8Bits
  - RAM ..... 16Words × 4Bits
- Input ports(ports E0~E3)
  - (Build-in the pull-up Transistor) ..... 4
- I/O ports(ports D)
  - (Build-in the pull-up Transistor) ..... 1
- Output ports(ports C, F0~F7) ..... 9

**USE**

- Various remote control transmitters

□ BLOCK DIAGRAM

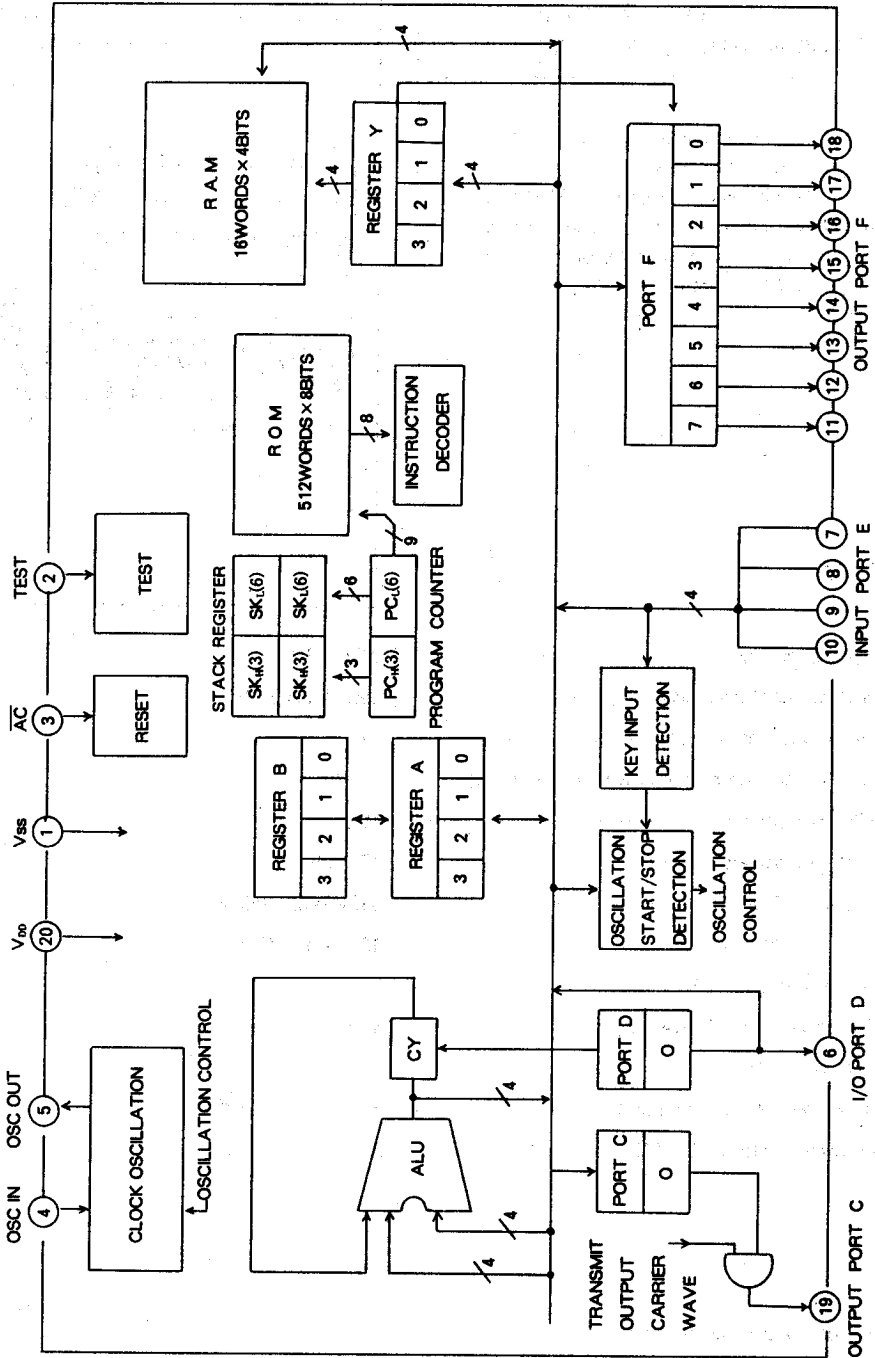

# DMC 6003-XXX

## FUNCTIONS

Parameter		Function
Number of Basic Instructions		37
Instructions Execution Time(One Word Instructions)		17.58 $\mu$ S( $F_{osc} = 455$ KHz)
Clock Frequency( $F_{osc}$ )		455kHz, OR 480KHz
Memory Size	ROM	512 Words $\times$ 8 Bits
	RAM	16 Words $\times$ 4 Bits
I/O ports	C Output	1 Bit $\times$ 1
	D I/O	1 Bit $\times$ 1
	E Input	4 Bit $\times$ 1
	F Output	1 Bit $\times$ 8
Subroutine Nesting		2 Levels
Clock Oscillating Circuit		Build-in
Transmission Output Carrier(port C)		$F_{osc} / 12$
Supply Voltage		2.2V~3.6V
Device Structure		CMOS Silicon Gate Process
Package		20 Pin Plastic Molded DIP/SOP
Power Dissipation ( $V_{DD} = 3V$ )	At Normal Operating	0.3mW (typ.)
	At Standby Mode	3 $\mu$ W(max.)

# DMC 6003-XXX

## □ PIN DESCRIPTION

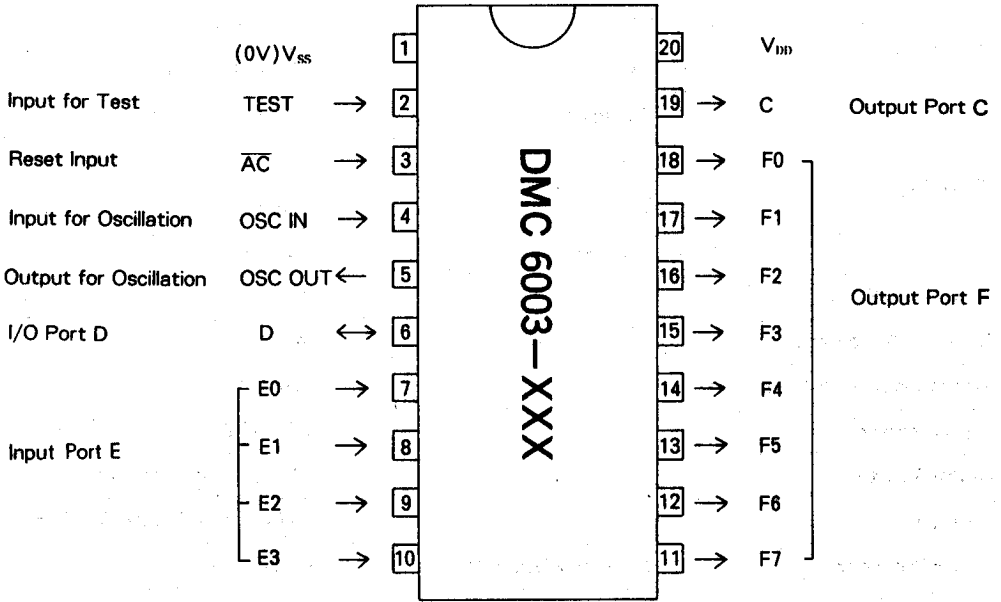

OUT LINE 20 PIN

PIN DESCRIPTION(CONTINUED)

Pin	Name	I/O	Function
V <sub>SS</sub>	GND		GND
V <sub>DD</sub>	Power Supply		+ Power Supply
TEST	Input for Test	INPUT	This is Usually Connected to V <sub>SS</sub>
AC	Reset Input	INPUT	To Enter the Reset State "L"
OSC IN	Input for Oscillating	INPUT	Connect A Ceramic Resonator to These Pins
OSC OUT	Output for Oscillating	OUTPUT	
C	Output Port C	OUTPUT	Output for Transmission(CMOS Output)
D	I/O Port D	I/O	1 Bit I/O(N Channel Open Drain Output)
E <sub>0</sub> ~E <sub>3</sub>	Input Port E	INPUT	4 Bit Input (Build-In The Pull-Up Transistor)
F <sub>0</sub> ~F <sub>7</sub>	Output Port F	OUTPUT	8 Bit Output(N Channel Open Drain Output, Key Scan Output)

ABSOLUTE MAXIMUM RATINGS

Symbol	Parameter	Condition	Rating	Unit
V <sub>DD</sub>	Supply Voltage	T <sub>a</sub> =25°C	-0.3~4	V
V <sub>I</sub>	Input Voltage		$V_{SS}-0.3 \leq V_I \leq V_{DD}+0.3$	V
V <sub>O</sub>	Output Voltage		$V_{SS} \leq V_O \leq V_{DD}$	V
P <sub>w</sub>	Power Dissipation		300	mW
T <sub>opr</sub>	Operating Temperature		-20~70	°C
T <sub>stg</sub>	Storage Temperature		-40~125	°C

SYMBOL DESCRIPTION

Symbol	Contents
A, B, Y	4 Bit Register
DP	4 Bit Data Pointer (Consisting of the Register Y)
PC <sub>H</sub>	The Higher 3 Bits of the Program Counter
PC <sub>L</sub>	The Lower 6 Bits of the Program Counter
PC	9 Bit Program Counter (Consisting of PC <sub>H</sub> , And PC <sub>L</sub> )
SK	9 Bit Stack Register
CY	1 Bit Carry Flag
C, D	1 Bit Port
E	4 Bit Port
F	8 Bit Port
←	Direction in Which Data is Transferred
y <sub>3</sub> y <sub>2</sub> y <sub>1</sub> y <sub>0</sub>	4 Bit Binary Variable
n <sub>3</sub> n <sub>2</sub> n <sub>1</sub> n <sub>0</sub>	4 Bit Binary Constant
a <sub>5</sub> a <sub>4</sub> a <sub>3</sub> a <sub>2</sub> a <sub>1</sub> a <sub>0</sub>	Label to Show the Address
p <sub>2</sub> p <sub>1</sub> p <sub>0</sub>	Label to Show the Address

SOP DIMENSION (DMC6003-×××V)

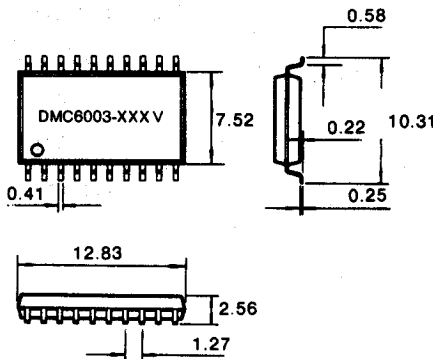

# DMC 6003-XXX

## BASIC TIMING BLOCK

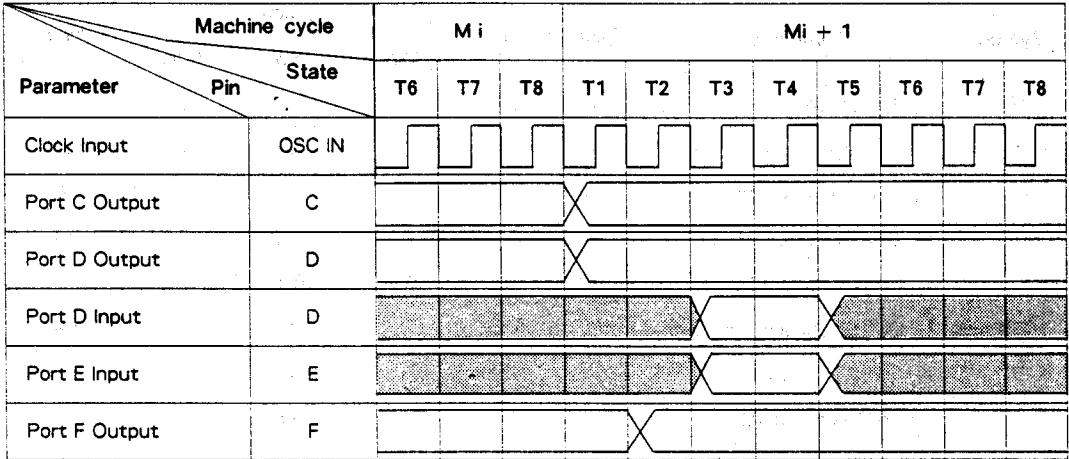

## RECOMMENDED OPERATING CONDITIONS

(Ta = -20~70°C)

Symbol	Parameter	Limits			Unit
		Min.	Typ.	Max.	
V <sub>DD</sub>	Supply Voltage	2.2	—	3.6	V
V <sub>BI</sub>	"H" Input Voltage Ports E, D	0.8 V <sub>DD</sub>	V <sub>DD</sub>	V <sub>DD</sub>	V
	"H" Input Voltage $\overline{AC}$	0.7 V <sub>DD</sub>	V <sub>DD</sub>	V <sub>DD</sub>	
V <sub>IL</sub>	"L" Input Voltage Port E, D	0	0	0.4 V <sub>DD</sub>	V
	"L" Input Voltage $\overline{AC}$	0	0	0.3 V <sub>DD</sub>	
Fosc	Oscillating Frequency	—	455 480	—	KHz

## □ ELECTRICAL CHARACTERISTICS

(Ta=25°C, V<sub>DD</sub>=3V, V<sub>SS</sub>=0V)

Symbol	Parameter	Test Condition	Limits			Unit
			Min.	Typ.	Max.	
V <sub>DD</sub>	Supply Voltage	Fosc=455KHz, Ta=20~70°C	2.2		3.6	V
I <sub>DD</sub>	Supply Current	Fosc = 455KHz		0.1	0.3	mA
I <sub>DD</sub>	Supply Current At Stop				1	μA
I <sub>OH</sub>	"H" Output Current Port C	V <sub>OH</sub> =2V	-5	-10		mA
I <sub>OL</sub>	"L" Output Current Port C	V <sub>OL</sub> =0.9V	0.3	0.8		
	"L" Output Current Port C		1	4		mA
	"L" Output Current Port D		1	4		
R <sub>i</sub>	Pull-up Resistance AC				80	
	Pull-up Resistance Port D			70		KΩ
	Pull-up Resistance Port E			70		

## □ BASIC FUNCTION BLOCK

### ○ Program Memory ROM

A Mask ROM consisting of 512 Words × 8 Bits can be used to Program User-Specified Instruction Codes.  
 (However, Input Test Data to Addresses 500~511)

• Address 0(00<sub>16</sub>)

• Address 511(1FF<sub>16</sub>)

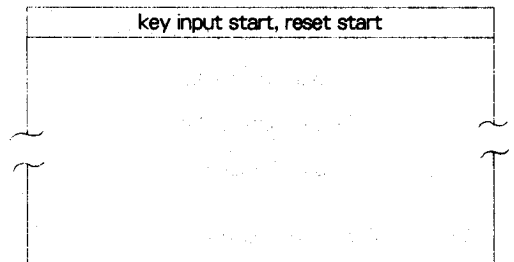

-ROM ADDRESS MAP-



○ Program Counter (PC)

This is a counter used to specify the ROM address and determine the read sequence of program instructions written in the ROM. The program counter consists of 9 bits.

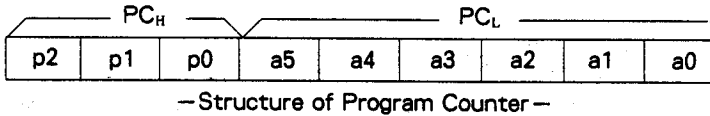

○ Stack Register (SK)

This is a register used to temporarily store the contents of the PC before a subroutine is called and until the original routine is returned after a subroutine call.

○ Data Memory RAM

This is used for storage of various types of processed data and control data. It has a size of 16 words 4 bits (64 bits). One word of RAM consists of 4 bit, but processing can be performed on the entire memory area.

BIT NUMBER	0				1				
	Y3	3	2	1	0	3	2	1	0
Y0~Y2									
0									
1									
⋮									
6									
7									

— RAM ADDRESS MAP —

○ Data Pointer (DP)

This is a register used to specify the RAM address and the bit position of output port F. The upper 1 bit (Y3) of DP specifies the RAM file and the lower three bits (Y0~Y2) specify the RAM digits.

## ○ Clock Oscillating Circuit

Since, the CMOS inverter and feed-back pull-up resistor are built into the IC, the standard signal can be obtained by connecting a ceramic resonator between the oscillator circuit input terminal and the output terminal. (osc in and osc out)

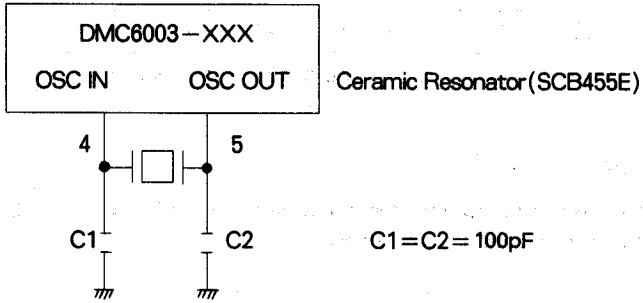

—EXTERNAL CERAMIC RESONATOR CIRCUIT—

## ○ Auto Clear Function

The auto clear function can be activated by connecting a capacitor to the  $\overline{AC}$  pin while power is applied. In addition to activate the auto clear function, The time ( $T_c$ ) must be longer than 0.1mS, when the voltage in becomes higher than  $0.3V_{DD}$  after the Voltage  $V_{DD}$  pin exceeds 2.2V. When the auto function is activated, the standby state continues until an "L" is input to port E.

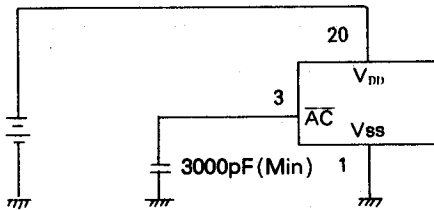

—AUTO CLEAR CIRCUIT—

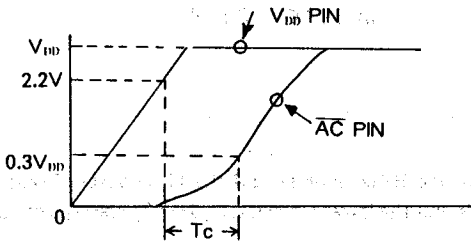

—AUTO CLEAR OPERATING CONDITION—

- 4 Bit Arithmetic And Logical Unit

This unit is used to perform 4 bit logical operations such as addition, subtraction comparison, and bit manipulation.

- Register A And Carry Flag(CY)

Register A is a central register that consists of 4 bits. The carry flag(CY) stores the carry or borrow from the most significant position of the arithmetic logic unit after various instruction execution.

It can also be used as a 1-bit flag.

- Register B

Register B consists of 4 bits and can be used for temporary storage of data from register A

- I/O Ports

- 1) Port C

Port C's function is to output(OCA) 1 bit data from register A, When it is set to "H", the transmitting signal, with carrier of the  $f_{osc}/12$  frequency, is output to the port C terminal. The output structure is CMOS output.

- 2) Port D

Port D's function is to output(ODA) and input (IAD) 1 bit in register A. Port D should be used as a dedicated port for either input or output.

- 3) Port E

Port E's function is to input(AE) 4 bit data. It contains a pull-up resistor and should be used for key input from the key matrix.

If an "L" is input while in the standby mode. It releases the standby state and restarts oscillation.

- 4) Port F

Port F has an 8 bit output(SF, RF) function with a single-bit latch. Output is performed by port F by using register Y as a data pointer. The output structure is N-channel open drain.

## ○ Counter Circuit

This IC contains a counter circuit which counts the reference signals obtained by the clock oscillating circuit. This operation is as follows.

- 1) In the standby mode the oscillation circuit stops, but when a key entry is performed (Input Port E Series "L"), The oscillation circuit starts again. The counter circuit starts counting the reference signal at the beginning of oscillation and informs the program counter of the start operation instruction after counting 12288 pulses. From this point, the program counter starts operation at address 0.
- 2) If the output port C does not change from "L" → "H" before the counter circuit counts 49152 pulses, the value of the counter circuit returns to 0 and the counter circuit restarts from 0. The count value of the counter circuit cannot be modified by the program.

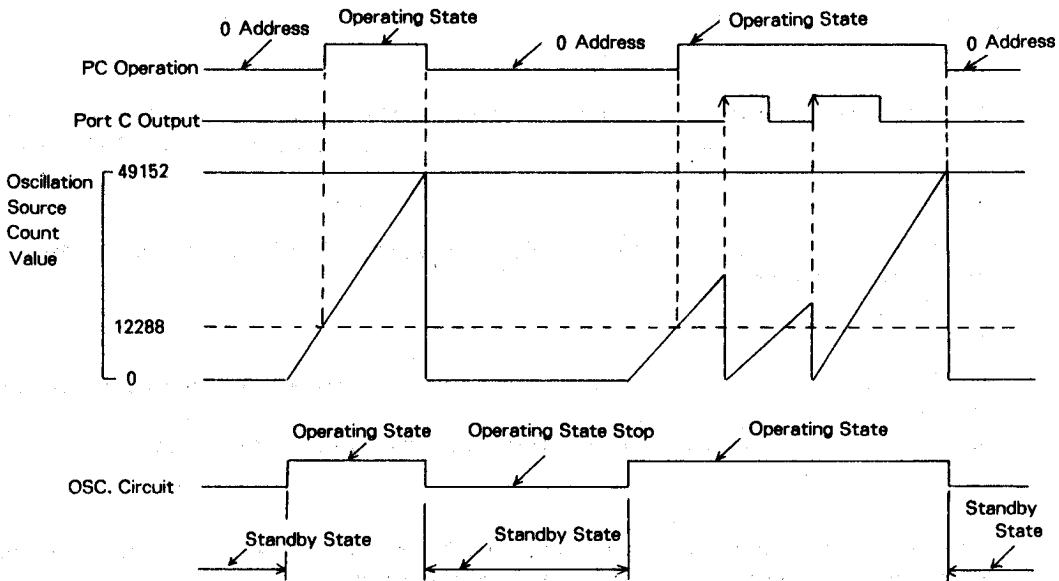

— Relationship between the value of the internal counter circuit and the standby state —

## ○ Standby Mode

The following conditions exist in the standby mode

- 1) The oscillating circuit stops
- 2) The program counter is set to address 0

○ Standby Mode(Continued)

3) The output latch of port D is "0"

4) The output latch of port F is "0"

○ Data required for MASK operating (Please send the following data for MASK orders)

1) DMC6003-XXX MASK confirmation sheet

2) ROM data ..... EPROM 3 sets

Always Include The Test ROM Data With The ROM Data

-ROM ADDRESS MAP FOR TEST-

PROGRAM ADDRESS			ROM ADDRESS			INSTRUCTIONS	ROM DATA
PCH	PCL	9 BIT HEX	PCH	PCL	9 BIT HEX		
07	34	1F4	04	26	126	LY B	2B
07	35	1F5	04	0C	10C	TAY	7A
07	36	1F6	04	19	119	TMA	66
07	37	1F7	04	32	132	LA A	4A
07	38	1F8	04	25	125	RC	06
07	39	1F8	04	0A	10A	AMC	7C
07	3A	1F9	04	15	115	NE ODA	6F
07	3B	1FB	04	2A	12A	RAR	7E
07	3C	1FC	04	14	114	INY	72
07	3D	1FD	04	28	128	B NE	D5
07	3E	1FE	04	10	110	ME B ME	D0
07	3F	1FF	04	20	120	STOP	01

Note) On the DMC6003-XXX, The ROM size is 512 words, but the test instructions should always be inserted in the address shown in the table.

This is because 12 words are used for testing.

A SINGLE PULSE MODULATED WITH A 37.9KHz SIGNAL (F<sub>osc</sub> = 455KHz)

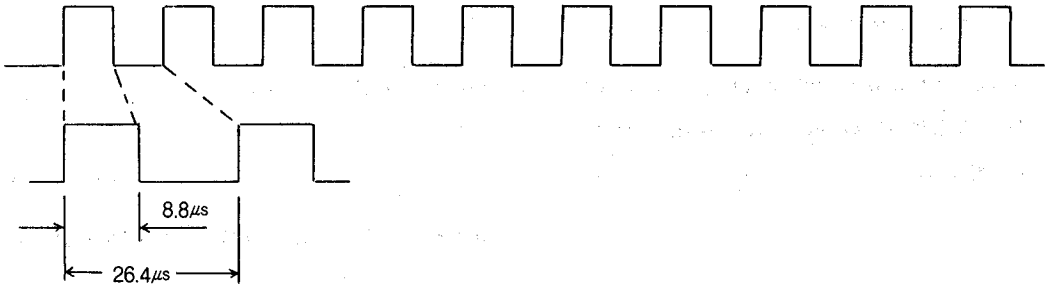

THE DISTINCTION BETWEEN THE "0" AND "1" CODES

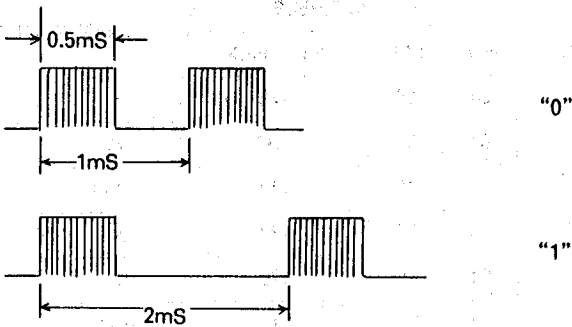

SINGLE-WORD FORMAT

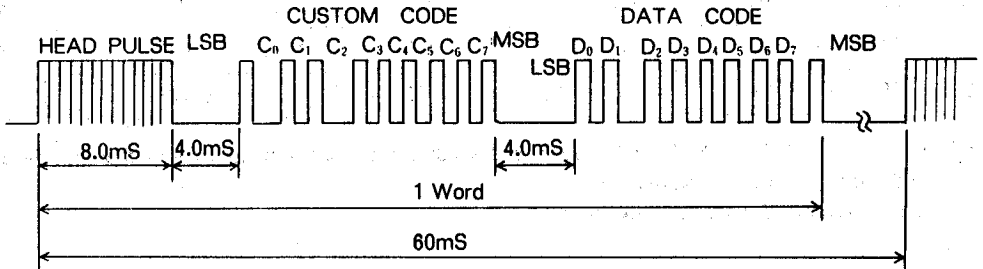

# DMC 6003-XXX

RELATIONSHIP BETWEEN TRANSMISSION CODE AND KEY POSITIONS

TRANSMISSION CODE									KEY POSITION
D7	D6	D5	D4	D3	D2	D1	D0	HEX	
0	0	0	0	0	0	0	0	0 0	0
0	0	0	0	0	0	0	1	0 1	1
0	0	0	0	0	0	1	0	0 2	2
0	0	0	0	0	0	1	1	0 3	3
0	0	0	0	0	1	0	0	0 4	4
0	0	0	0	0	1	0	1	0 5	5
0	0	0	0	0	1	1	0	0 6	6
0	0	0	0	0	1	1	1	0 7	7
0	0	0	0	1	0	0	0	0 8	8
0	0	0	0	1	0	0	1	0 9	9
0	0	0	0	1	0	1	0	0 A	10
0	0	0	0	1	0	1	1	0 B	11
0	0	0	0	1	1	0	0	0 C	12
0	0	0	0	1	1	0	1	0 D	13
0	0	0	0	1	1	1	0	0 E	14
0	0	0	0	1	1	1	1	0 F	15
0	0	0	1	0	0	0	0	1 0	16
0	0	0	1	0	0	0	1	1 1	17
0	0	0	1	0	0	1	0	1 2	18
0	0	0	1	0	0	1	1	1 3	19
0	0	0	1	0	1	0	0	1 4	20
0	0	0	1	0	1	0	1	1 5	21
0	0	0	1	0	1	1	0	1 6	22
0	0	0	1	0	1	1	1	1 7	23
0	0	0	1	1	0	0	0	1 8	24
0	0	0	1	1	0	0	1	1 9	25
0	0	0	1	1	0	1	0	1 A	26
0	0	0	1	1	1	0	0	1 B	27
0	0	0	1	1	1	0	1	1 C	28
0	0	0	1	1	1	0	1	1 D	29
0	0	0	1	1	1	1	0	1 E	30
0	0	0	1	1	1	1	1	1 F	31

# DMC 6003-XXX

## DMC6003-XXX EXTERNAL CONNECTION EXAMPLE(1)

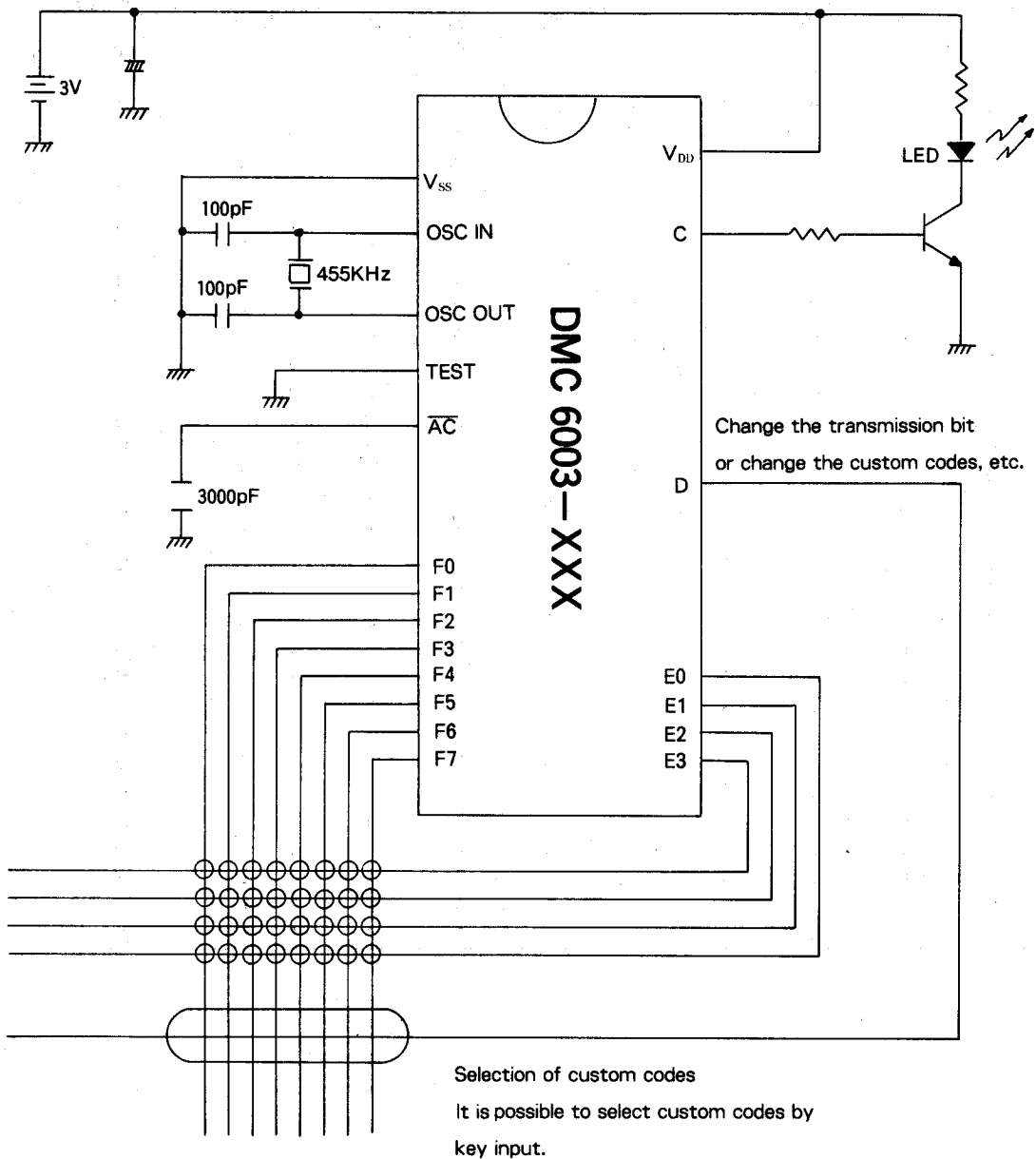



# DMC 6003-XXX

## DMC6003-XXX EXTERNAL CONNECTION EXAMPLE(2)

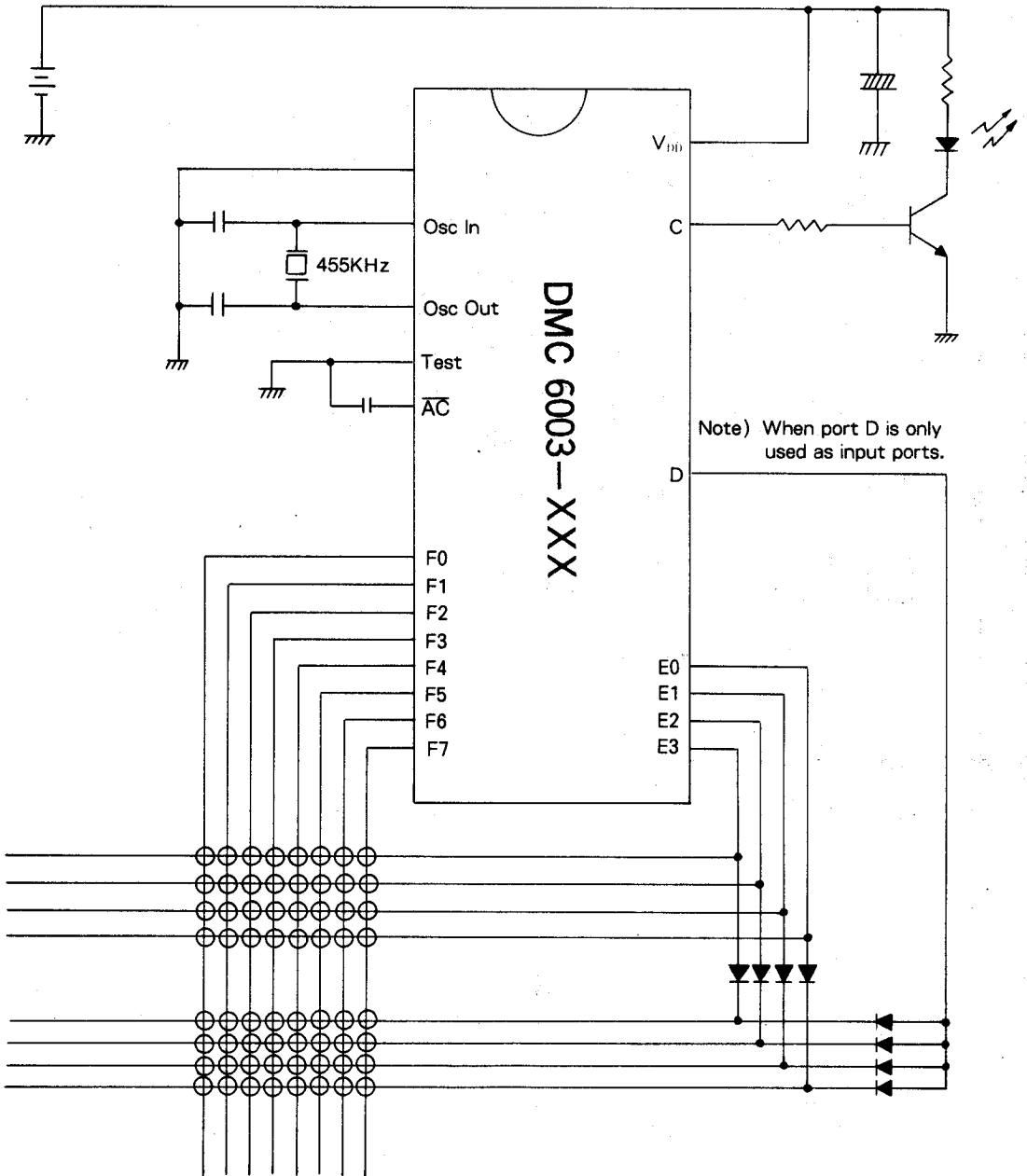

# DMC 6003-XXX

## EXTERNAL CONNECTION SAMPLE(3)

