



Dual Output BMP Models

5V and 3.3V, 2" x 3"
35 Watt, DC/DC Converters

Features

- Independent 5V @ 4.7A and 3.3V @ 3.5A Outputs
- Each output fully regulated
- 35 Watts total output power
- Standard 2" x 3" package
- UL1950 and EN60950 safety approvals (BASIC insulation, -D48 model)
- Fully isolated, 1500Vdc guaranteed
- 18-36V or 36-75V input ranges
- CE mark available (75V-input models)
- Your trim and on/off control
- Fully I/O protected
- Thermal shutdown

For your moderate-power mixed-logic designs, DATEL's BMP-5/5-3.3/4-D24 (18-36V input) and BMP-5/5-3.3/4-D48 (36-75V input) are fully isolated DC/DC converters providing both 5V and 3.3V outputs. Housed in DATEL's standard 2" x 3" x 0.5" metal packages, these BMP duals can simultaneously source up to 4.7 Amps from their 5V outputs and up to 3.5 Amps from their 3.3V outputs. Both outputs are fully isolated (1500Vdc) and independently line ($\pm 1.0\%$) and load ($\pm 1.0\%$) regulated.

Both models feature input pi filters, input overvoltage shutdown, input reverse-polarity protection, output overvoltage protection, output current limiting, and thermal shutdown. Both outputs are controlled via the On/Off Control function (pin 5). The 5 Volt output can be adjusted $\pm 5\%$.

BMP Model DC/DC's deliver high efficiency (82%) and are fully specified for -40 to $+100^\circ\text{C}$ operation. Their corrosion-resistant metal cases have non-conductive baseplates and threaded inserts for easy heat-sink attachment and/or pcb mounting. These devices satisfy IEC950, UL1950 and EN60950 safety requirements for BASIC insulation. CE marking is available for "D48" models.

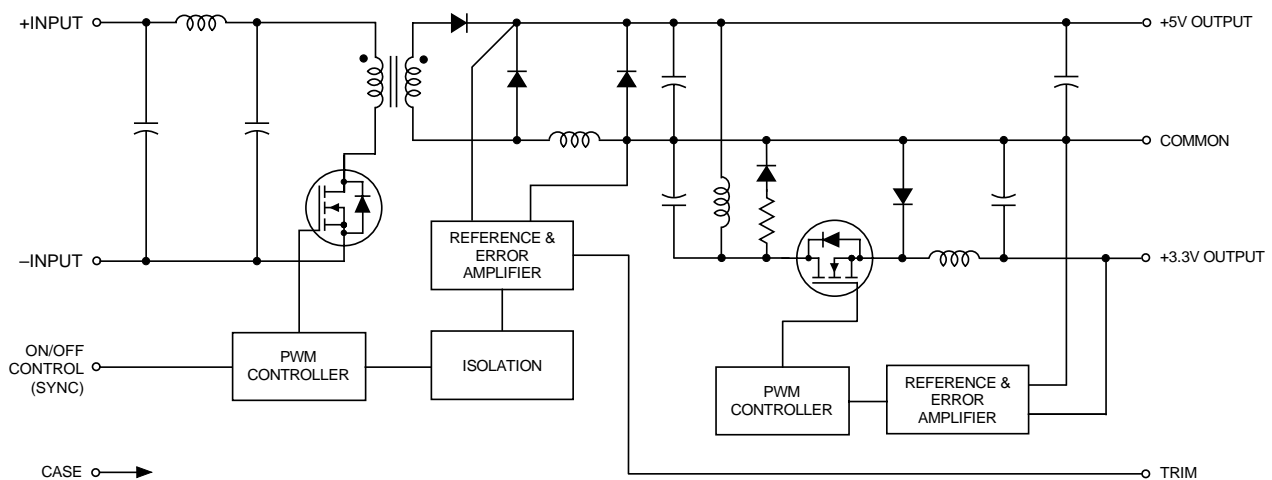

Figure 1. Simplified Schematic

Performance Specifications and Ordering Guide ①

Model	Output				Input			Efficiency		Package (Case, Pinout)		
	V _{OUT} (Volts)	I _{OUT} ② (Amps)	R/N (mVp-p) ③		Regulation (Max.)		V _{IN} Nom. (Volts)	Range (Volts)	I _{IN} ⑤ (mA)		Min.	Typ.
			Typ.	Max.	Line	Load ④						
BMP-5/5-3.3/4-D24	5	4.7	100	120	±1%	±1%	24	18-36	35/1870	79%	81%	C11, P44
	3.3	3.5	100	120	±1%	±1%						
BWR-5/6-3.3/4-D48	5	4.7	100	120	±1%	±1%	48	36-75	35/923	80%	82%	C11, P44
	3.3	3.5	100	120	±1%	±1%						

- ① Typical at T_A = +25°C under nominal line voltage and "full-load" conditions.
- ② Any combination of 5V/3.3V rated I_{OUT} current, not to exceed 35 Watts of output power. (See derating graphs.)
- ③ Ripple/Noise (R/N) measured over a 20MHz bandwidth. All models are specified with no output capacitors.
- ④ Tested from 10% load to 100% load (other output at fixed load).
- ⑤ Nominal line voltage, no load/balanced full-power condition.

PART NUMBER STRUCTURE

BMP - 5 / 5 - 3.3 / 4 - D48 S

Dual Output/
Mixed-Voltage Series

V₁ Nominal Output Voltage:
5 Volts

I₁ Maximum Output Current:
4.7 Amps

V₂ Nominal Output Voltage:
3.3 Volts

Input Voltage Range:
D24 = 18-36 Volts (24V nominal)
D48 = 36-75 Volts (48V nominal)

I₂ Maximum Output Current:
3.5 Amps

Add "S" suffix as desired

Part Number Suffixes

BMP 35 Watt DC/DC's are designed so an On/Off Control function with positive polarity (no suffix) or a Sync function ("S" suffix) can be added in the pin 5 position.

No Suffix On/Off Control function (positive polarity) on pin 5

S Suffix Sync function on pin 5

M E C A N I C A L S P E C I F I C A T I O N S

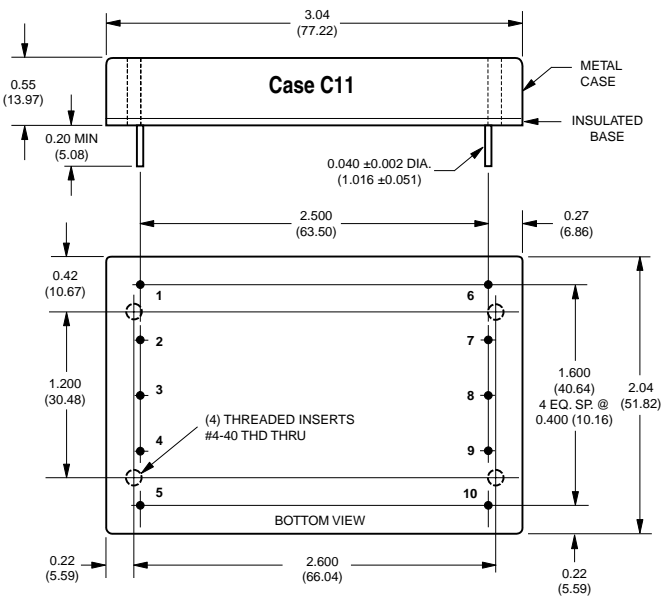

I/O Connections			
Pin	Function P44	Pin	Function P44
1	No Pin	6	No Pin
2	-Input	7	+3.3V Output
3	+Input	8	Output Return
4	Case	9	+5V Output
5	On/Off Control	10	Trim

Optional Heat Sink (Part Number HS-23)

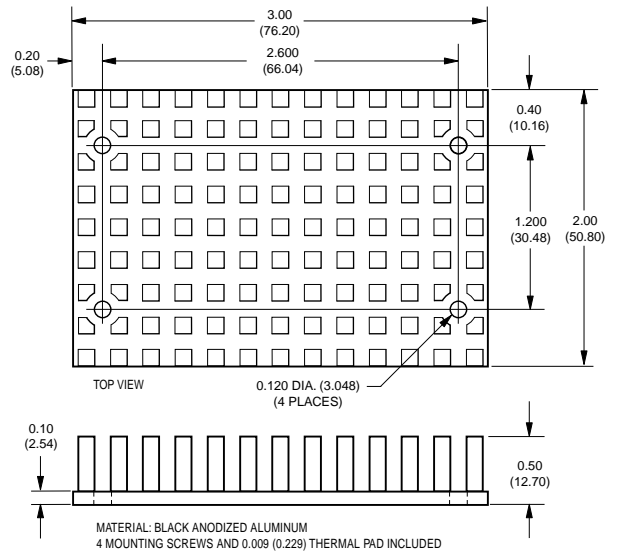

Performance/Functional Specifications

Typical @ T_A = +25°C under nominal line voltage, balanced "full-load" conditions, unless noted. ①

Input	
Input Voltage Range:	
D24 Models	18-36 Volts (24V nominal)
D48 Models	36-75 Volts (48V nominal)
Overvoltage Shutdown:	
D24 Models	36.4-43.6 Volts (40V nominal)
D48 Models	77-85 Volts (83V nominal)
Input Current:	
Normal Operating Conditions	See Ordering Guide
Standby Mode:	
Off, OV, Thermal Shutdown	10mA typical
Input Reflected Ripple Current:	
Source Impedance	<0.1Ω, no external input filtering
D24 & D48 Models	100mA _{p-p} (typical)
Internal Input Filter Type	Pi (4.5μF - 10μH - 7.5μF)
Reverse-Polarity Protection:	
D24 Models	1 minute duration, 3A maximum
D48 Models	1 minute duration, 2A maximum
On/Off Control (Pin 5): ③ ④ ⑥	
D24 & D48 Models	On = open or 2.6V - +V _{IN} , I _{IN} = 1.5mA max. Off = 0-1.2V, I _{IN} = 1.5mA max.
Output	
V_{OUT} Accuracy	
5V Output	±1% maximum
3.3V Output	±1.5% maximum
Minimum Loading Per Specification	10%
Ripple/Noise (20MHz BW) ⑤	See Ordering Guide
Line/Load Regulation	See Ordering Guide
Efficiency	See Ordering Guide
Trim Range +5V Output	±5%
Isolation Voltage:	
Input-to-Output	1500Vdc minimum
Case-to-Input	1000Vdc minimum
Case-to-Output	1000Vdc minimum
Isolation Capacitance	470pF
Isolation Resistance	100MΩ
Temperature Coefficient	±0.02%/per°C
Output (continued)	
Current Limit Inception:	
5V @ 98.5% V _{OUT} (3.3V @ 3.5A)	6-8 Amps
3.3V @ 98.5% V _{OUT} (5V @ 4.7A)	5-8 Amps
Short Circuit Current:	
5V Output	10 Amps average, continuous
3.3V Output	8 Amps average, continuous
Overvoltage Protection:	Magnetic feedback/transorb
5V Output	6.8 volts
Dynamic Characteristics	
Dynamic Load Response:	
5V (50-100% load step to 3% V _{OUT})	300μsec maximum
3.3V (50-100% load step to 3% V _{OUT})	300μsec maximum
Switching Frequency	150kHz (±15kHz)

Environmental	
MTBF ⑦	Bellcore, ground fixed, full power, +25°C operating ambient temperature
D24 Models	TBC million hours
D48 Models	TBC million hours
Operating Temperature (Ambient): ②	No heat sink
Without Derating:	-40 to +50°C
With Derating	To +100°C (See Derating Curves)
Case Temperature:	
Maximum Operational	+100°C
For Thermal Shutdown	+95°C minimum, +105°C maximum
Storage Temperature	-40 to +120°C
Physical	
Dimensions	2.04 x 3.04 x 0.55" (51.8 x 77.2 x 14mm)
Shielding	5-sided
Case Connection	Pin 4
Case Material	Zinc with a non-conductive, epoxy-based black enamel finish and plastic baseplate
Pin Material	Brass, solder coated
Weight:	6 ounces (170 grams)
Primary to Secondary Insulation Level	
D24 Models	Operational
D48 Models	Basic

- ① All models are specified with no external output capacitors.
- ② See Technical Notes/Graphs for details.
- ③ Devices may be ordered with On/Off Control function or a Sync function. See Part Number Suffixes and Technical Notes for details.
- ④ Applying a voltage to On/Off Control (pin 5) when no input power is applied to the converter may cause permanent damage.
- ⑤ Output noise may be further reduced with the installation of additional external output capacitors.
- ⑥ On/Off control is designed to be driven with open collector or by appropriate voltage levels. Voltages must be referenced to the input return pin (-Input).
- ⑦ Demonstrated MTBF available on request.

Absolute Maximum Ratings	
Input Voltage:	
D24 Models	42 Volts
D48 Models	88 Volts
Input Reverse-Polarity Protection	Current must be <3A. Brief duration only. Fusing recommended.
Output Overvoltage Protection	
+5V Outputs	6.8 Volts
Output Current	Current limited. Maximum current and short-circuit duration are model dependent.
Storage Temperature	-40 to +105°C
Lead Temperature (Soldering, 10 sec.)	+300°C
These are stress ratings. Exposure of devices to any of these conditions may adversely affect long-term reliability. Proper operation under conditions other than those listed in the Performance/Functional Specifications Table is not implied, nor recommended.	

On/Off Control (Standard)

The On/Off Control pin (pin 5) may be used for remote on/off operation. As shown in Figure 6, the control pin has an internal 10kΩ pull-up resistor to approximately 10V. The converter is designed so that it is enabled when the control pin is left open (normal mode) and disabled when the control pin is pulled low (to less than +1.2V relative to -Input, pin 2).

Dynamic control of the on/off function is best accomplished with a mechanical relay or an open-collector/open-drain drive circuit (optically isolated if appropriate). The drive circuit should obviously be able to sink approximately 1.5mA when activated and withstand more than 10 Volts when deactivated.

Applying an external voltage to pin 5 when no input power is applied to the converter can cause permanent damage to the converter. The on/off control function, however, is designed such that the converter can be disabled (pin 5 pulled low) while input power is ramping up and then "released" once the input has stabilized. Under these circumstances, it takes approximately 30ms for the output of the fully loaded DC/DC to ramp up and settle to within ±1% of its final value after the converter has been turned on.

Synchronization (Optional)

In critical applications employing multiple switching DC/DC converters, it may be desirable to intentionally synchronize the switching of selected converters (so the system noise can be reduced with notch filtering) or to purposely desynchronize the converters (to lessen the current-carrying requirements on intermediate dc buses). BMP DC/DC Converters have been designed so that the On/Off Control function on pin 5 can be replaced with a Sync function. This change has to be implemented by DATEL during the product assembly process. Contact our Applications Engineering Group for additional details.

To synchronize the switching of multiple BMP converters configured with the Sync function, an external clock can be applied to pin 5 of each converter. The clock should be a TTL square wave referenced to -Input (logic high = +2 to +5 Volts, 250µA max.; logic low = 0 to +0.8 Volts, 70µA max.) with a maximum 1µsec "high" duration. The frequency of the synchronizing clock should be higher than that of any individual converter.

Output Trimming

The total output voltage span of the 5 Volt output, from +5V Output (pin 9) to Output Return (pin 8) may be trimmed ±5% via a single trimpot or fixed resistor. The trimpot should be connected as shown in Figure 3 with its wiper connected to pin 10 (Trim). A trimpot can also be used to determine the value of a single fixed resistor which can be connected between pin 10 (Trim) and pin 9 (+5V Output) to trim "down" the output voltages, or between pins 10 (Trim) and 8 (Output Return) to trim "up" the output voltages. Fixed resistors should have absolute TCR's less than 100ppm/°C to ensure stability.

Case Connection

Unlike most other DC/DC converters, BMP DC/DC's do not have their metal case connected to one of their input pins. The "uncommitted" case is connected to pin 4 which, depending on your system configuration, should be connected to either +Input (pin 3) or -Input (pin 2).

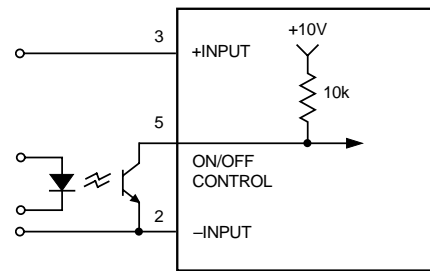

Figure 2. Driving the On/Off Control Pin

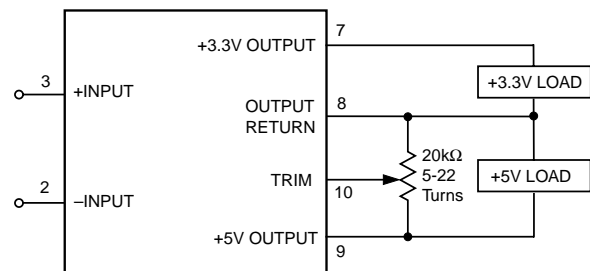
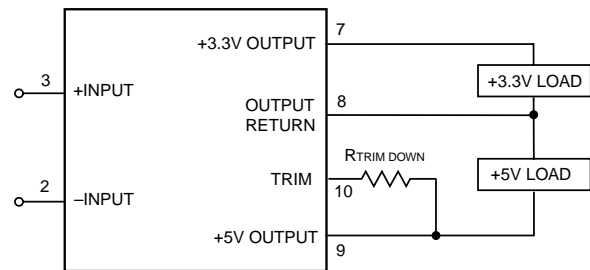
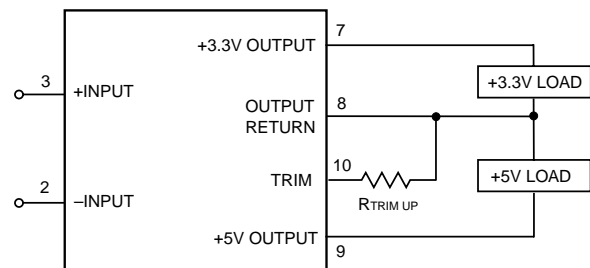

Figure 3. +5Vout Trim Connections Using A Trim Pot



$$R_{T_DOWN} (k\Omega) = \frac{2.49(V_O - 2.53)}{5 - V_O} - 16.2$$

Figure 4. +5Vout Trim Down Connections Using A Fixed Resistor



$$R_{T_UP} (k\Omega) = \frac{6.30}{V_O - 5} - 16.2$$

Figure 5. +5Vout Trim Up Connections Using A Fixed Resistor

Note: Resistor values are in kΩ. Accuracy of adjustment is subject to tolerances of resistors and factory-adjusted output accuracy.
V_O = desired output voltage.

Typical Performance Curves

D24 and D48 Models

Output Power vs. Ambient Temperature
 V_{IN} = Nominal Without Additional Heat Sink

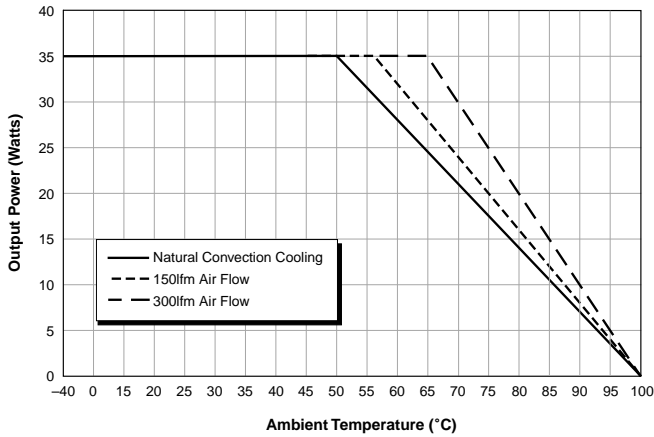

Output Power vs. Ambient Temperature
 V_{IN} = Nominal With Additional Heat Sink

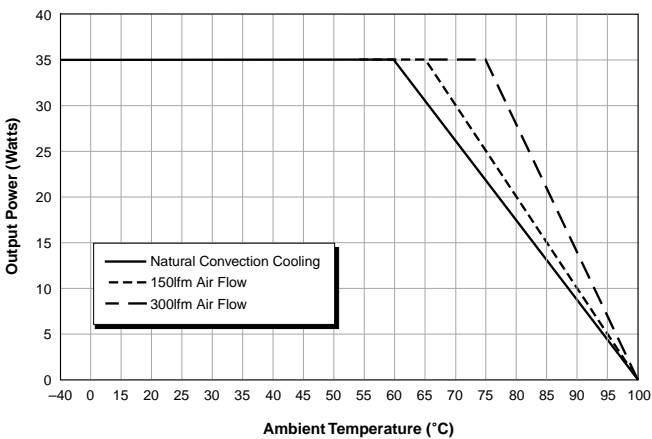

BMP-5/5-3.3/4-D24 Efficiency vs. Line Voltage @ Full Load

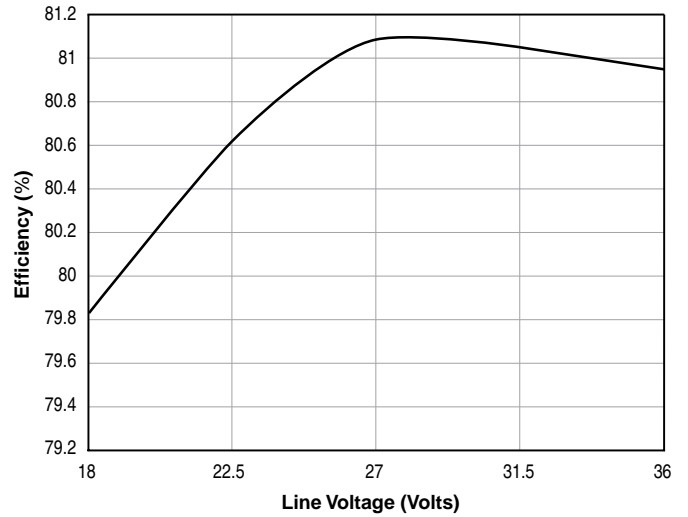

BMP-5/5-3.3/4-D48 Efficiency vs. Line Voltage @ Full Load

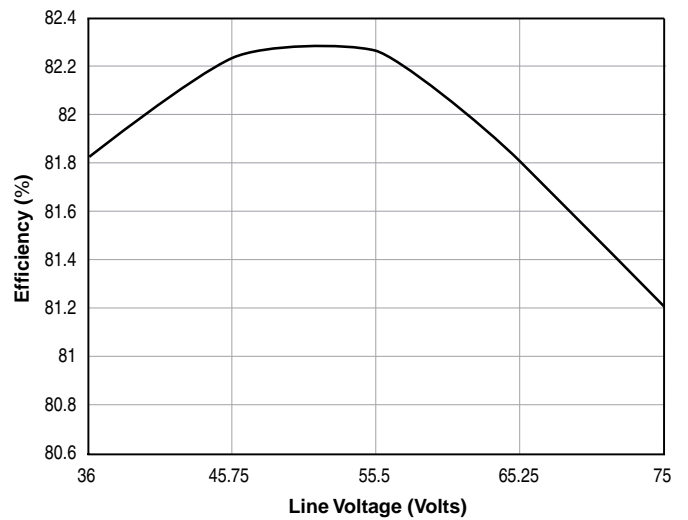

ISO 9001 REGISTERED

DS-0494A 2/01

DATEL, Inc. 11 Cabot Boulevard, Mansfield, MA 02048-1151
 Tel: (508) 339-3000 (800) 233-2765 Fax: (508) 339-6356
 Internet: www.datel.com Email: sales@datel.com

DATEL (UK) LTD. Tadley, England Tel: (01256)-880444
 DATEL S.A.R.L. Montigny Le Bretonneux, France Tel: 01-34-60-01-01
 DATEL GmbH München, Germany Tel: 89-544334-0
 DATEL KK Tokyo, Japan Tel: 3-3779-1031, Osaka Tel: 6-6354-2025

DATEL makes no representation that the use of its products in the circuits described herein, or the use of other technical information contained herein, will not infringe upon existing or future patent rights. The descriptions contained herein do not imply the granting of licenses to make, use, or sell equipment constructed in accordance therewith. Specifications are subject to change without notice. The DATEL logo is a registered DATEL, Inc. trademark.