



DC COMPONENTS CO., LTD.

RECTIFIER SPECIALISTS

**1N4001G
THRU
1N4007G**

TECHNICAL SPECIFICATIONS OF GLASS PASSIVATED RECTIFIER

VOLTAGE RANGE - 50 to 1000 Volts

CURRENT - 1.0 Ampere

FEATURES

- * High reliability
- * Low cost
- * Low leakage
- * Low forward voltage drop
- * High current capability
- * Glass passivated junction

MECHANICAL DATA

- * Case: Molded plastic
- * Epoxy: UL 94V-0 rate flame retardant
- * Lead: MIL-STD-202E, Method 208 guaranteed
- * Polarity: Color band denotes cathode end
- * Mounting position: Any
- * Weight: 0.33 gram

MAXIMUM RATINGS AND ELECTRICAL CHARACTERISTICS

Ratings at 25 °C ambient temperature unless otherwise specified.
Single phase, half wave, 60 Hz, resistive or inductive load.
For capacitive load, derate current by 20%.

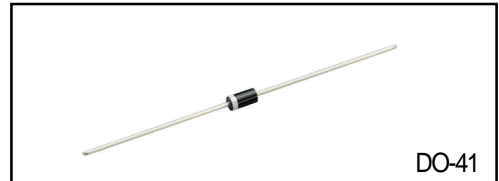

DO-41

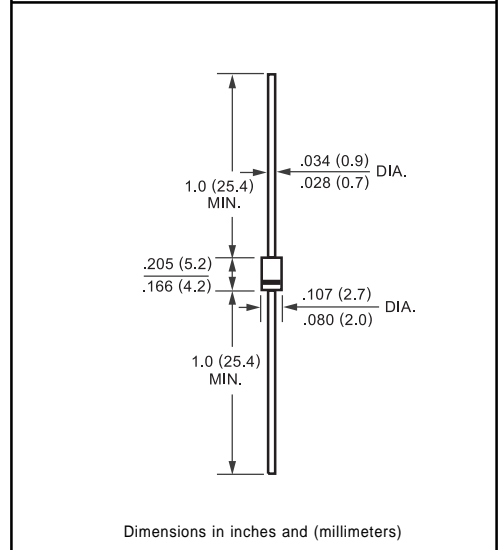

Dimensions in inches and (millimeters)

	SYMBOL	1N4001G	1N4002G	1N4003G	1N4004G	1N4005G	1N4006G	1N4007G	UNITS
Maximum Recurrent Peak Reverse Voltage	V _{RRM}	50	100	200	400	600	800	1000	Volts
Maximum RMS Voltage	V _{RMS}	35	70	140	280	420	560	700	Volts
Maximum DC Blocking Voltage	V _{DC}	50	100	200	400	600	800	1000	Volts
Maximum Average Forward Rectified Current at T _A = 75°C	I _O	1.0							Amps
Peak Forward Surge Current 8.3 ms single half sine-wave superimposed on rated load (JEDEC Method)	I _{FSM}	30							Amps
Maximum Instantaneous Forward Voltage at 1.0A DC	V _F	1.1							Volts
Maximum DC Reverse Current at Rated DC Blocking Voltage	I _R	@ T _A = 25°C							uAmps
		@ T _A = 100°C							
Maximum Full Load Reverse Current Average, Full Cycle .375"(9.5mm) lead length at T _L = 75°C	I _R	30							uAmps
Typical Junction Capacitance (Note)	C _J	15							pF
Typical Thermal Resistance	R _{θJA}	50							°C/W
Operating and Storage Temperature Range	T _J , T _{STG}	-65 to + 175							°C

NOTES : Measured at 1 MHz and applied reverse voltage of 4.0 volts

RATING AND CHARACTERISTIC CURVES (1N4001G THRU 1N4007G)

FIG. 1 - TYPICAL FORWARD CURRENT DERATING CURVE

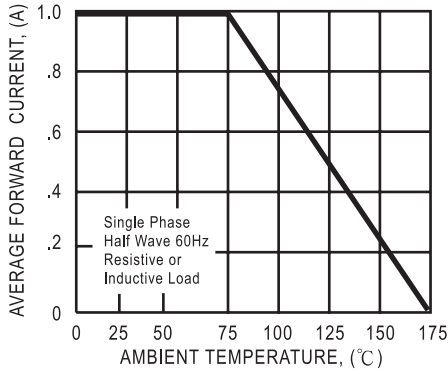

FIG. 2 - TYPICAL INSTANTANEOUS FORWARD CHARACTERISTICS

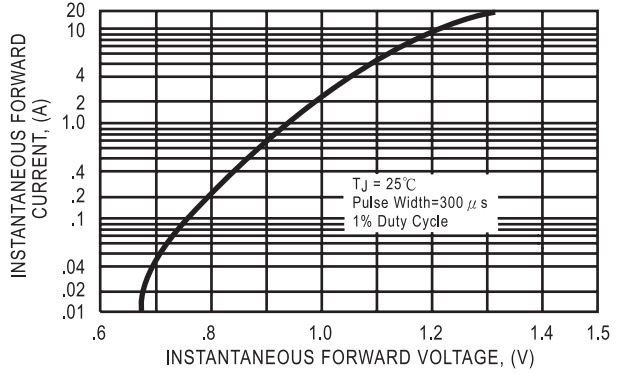

FIG. 3 - MAXIMUM NON-REPETITIVE FORWARD SURGE CURRENT

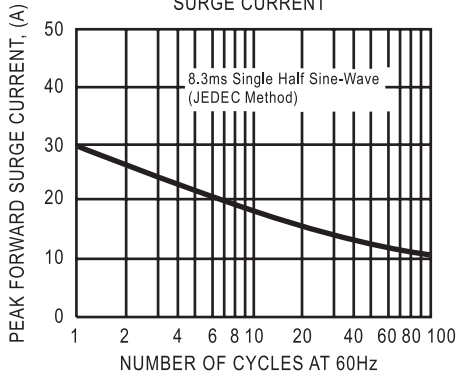

FIG. 4 - TYPICAL REVERSE CHARACTERISTICS

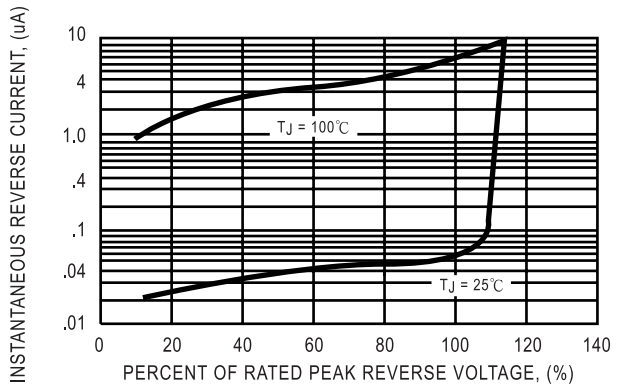
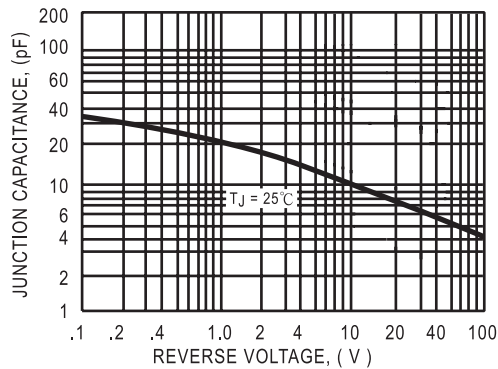

FIG. 5 - TYPICAL JUNCTION CAPACITANCE



DC COMPONENTS CO., LTD.