

**APPLICATIONS**

- Rectification
- Freewheel Diode
- DC Motor Control
- Power Supplies
- Welding
- Battery Chargers

**KEY PARAMETERS**

$V_{RRM}$	<b>2500V</b>
$I_{F(AV)}$	<b>180A</b>
$I_{FSM}$	<b>2200A</b>

**FEATURES**

- High Surge Capability

**VOLTAGE RATINGS**

Type Number	Repetitive Peak Reverse Voltage $V_{RRM}$ V	Conditions
SV10 25 M or K(R)	2500	$V_{RSM} = V_{RRM} + 100V$
SV10 20 M or K(R)	2000	
SV10 16 M or K(R)	1600	

Lower voltage grades available.  
 M for M12 thread. K for 1/2" - 20UNF thread, R for reverse polarity.  
 Add C to type number for DO8C package.

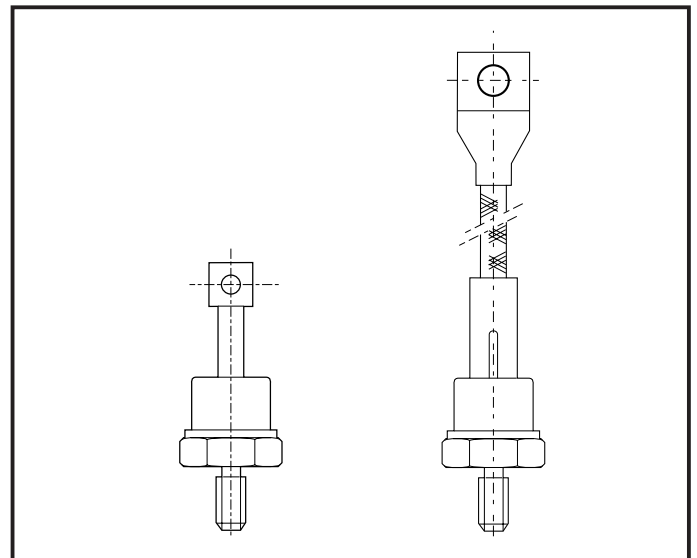

**Outline type codes: DO8C and DO8.**  
**See Package Details for further information.**

**CURRENT RATINGS**

Symbol	Parameter	Conditions	Max.	Units
<b>Single Side Cooled</b>				
$I_{F(AV)}$	Mean forward current	Half wave resistive load, $T_{case} = 100^{\circ}C$	180	A
$I_{F(RMS)}$	RMS value	$T_{case} = 100^{\circ}C$	283	A
$I_F$	Continuous (direct) forward current	$T_{case} = 100^{\circ}C$	233	A

# SV10

## SURGE RATINGS

Symbol	Parameter	Conditions	Max.	Units
$I_{FSM}$	Surge (non-repetitive) forward current	10ms half sine; $T_{case} = 175^{\circ}C$	1.76	kA
$I^2t$	$I^2t$ for fusing	$V_R = 50\% V_{RRM}$ - 1/4 sine	$14.9 \times 10^3$	A <sup>2</sup> s
$I_{FSM}$	Surge (non-repetitive) forward current	10ms half sine; $T_{case} = 175^{\circ}C$	2.2	kA
$I^2t$	$I^2t$ for fusing	$V_R = 0$	$24.0 \times 10^3$	A <sup>2</sup> s

## THERMAL AND MECHANICAL DATA

Symbol	Parameter	Conditions	Min.	Max.	Units
$R_{th(j-c)}$	Thermal resistance - junction to case	dc	-	0.23	$^{\circ}C/W$
$R_{th(c-h)}$	Thermal resistance - case to heatsink	Mounting torque 15.0Nm with mounting compound	-	0.08	$^{\circ}C/W$
$T_{vj}$	Virtual junction temperature	On-state (conducting)	-	175	$^{\circ}C$
		Reverse (blocking)	-	175	$^{\circ}C$
$T_{stg}$	Storage temperature range		-55	200	$^{\circ}C$
-	Mounting Torque		12.0	15.0	Nm

## CHARACTERISTICS

Symbol	Parameter	Conditions	Typ.	Max.	Units
$V_{FM}$	Forward voltage	At 300A peak, $T_{case} = 25^{\circ}C$	-	1.5	V
$I_{RRM}$	Peak reverse current	At $V_{RRM}$ , $T_{case} = 175^{\circ}C$	-	20	mA
$Q_S$	Total stored charge	$I_F = 100A$ , $di_{RR}/dt = 20A/\mu s$ , $T_{case} = 25^{\circ}C$	300*	-	$\mu C$
$I_{RM}$	Peak recovery current		100*	-	A
$t_{rr}$	reverse recovery time		6.5*	-	$\mu s$
$V_{TO}$	Threshold voltage	At $T_{vj} = 175^{\circ}C$	-	1.1	V
$r_T$	Slope resistance	At $T_{vj} = 175^{\circ}C$	-	1.3	m $\Omega$

\*Typical values.

CURVES

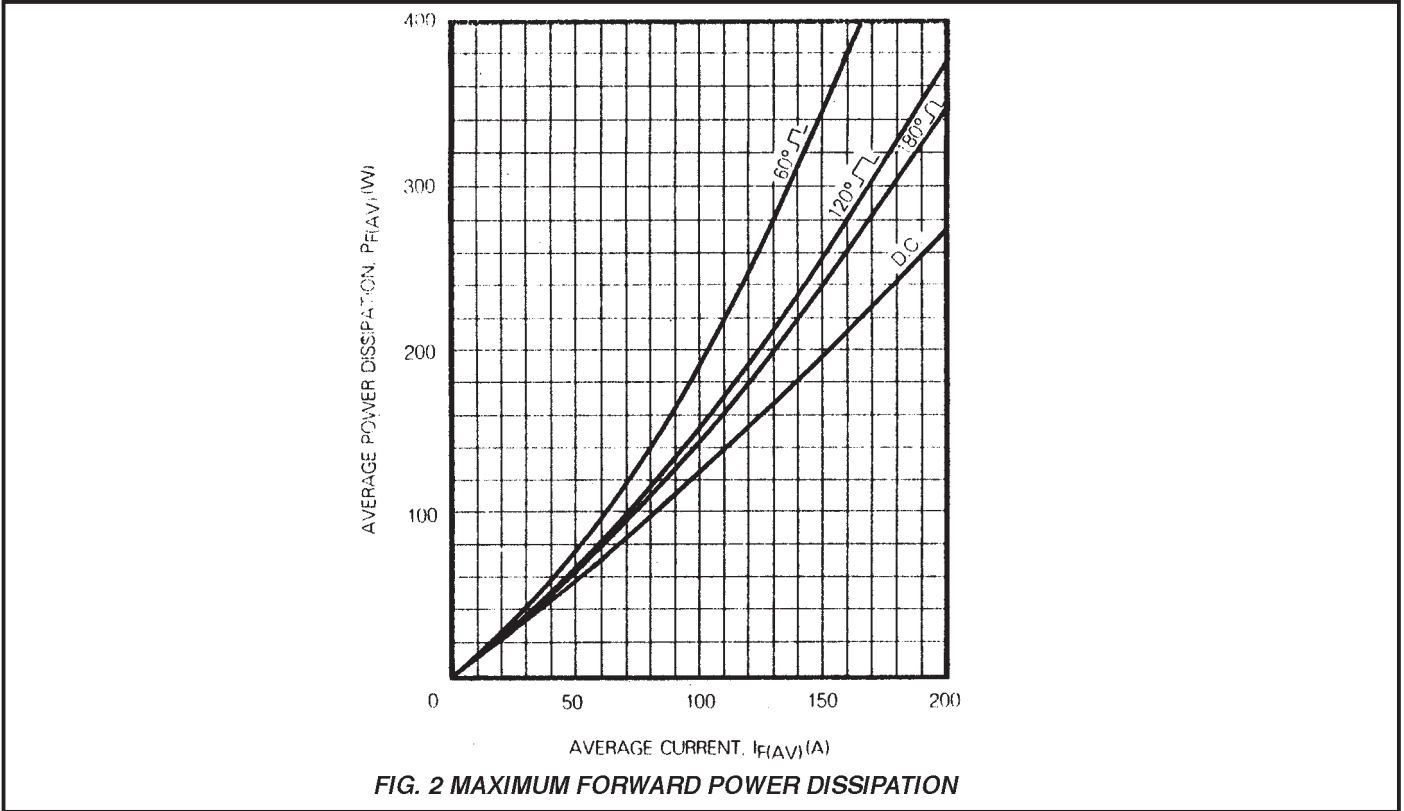
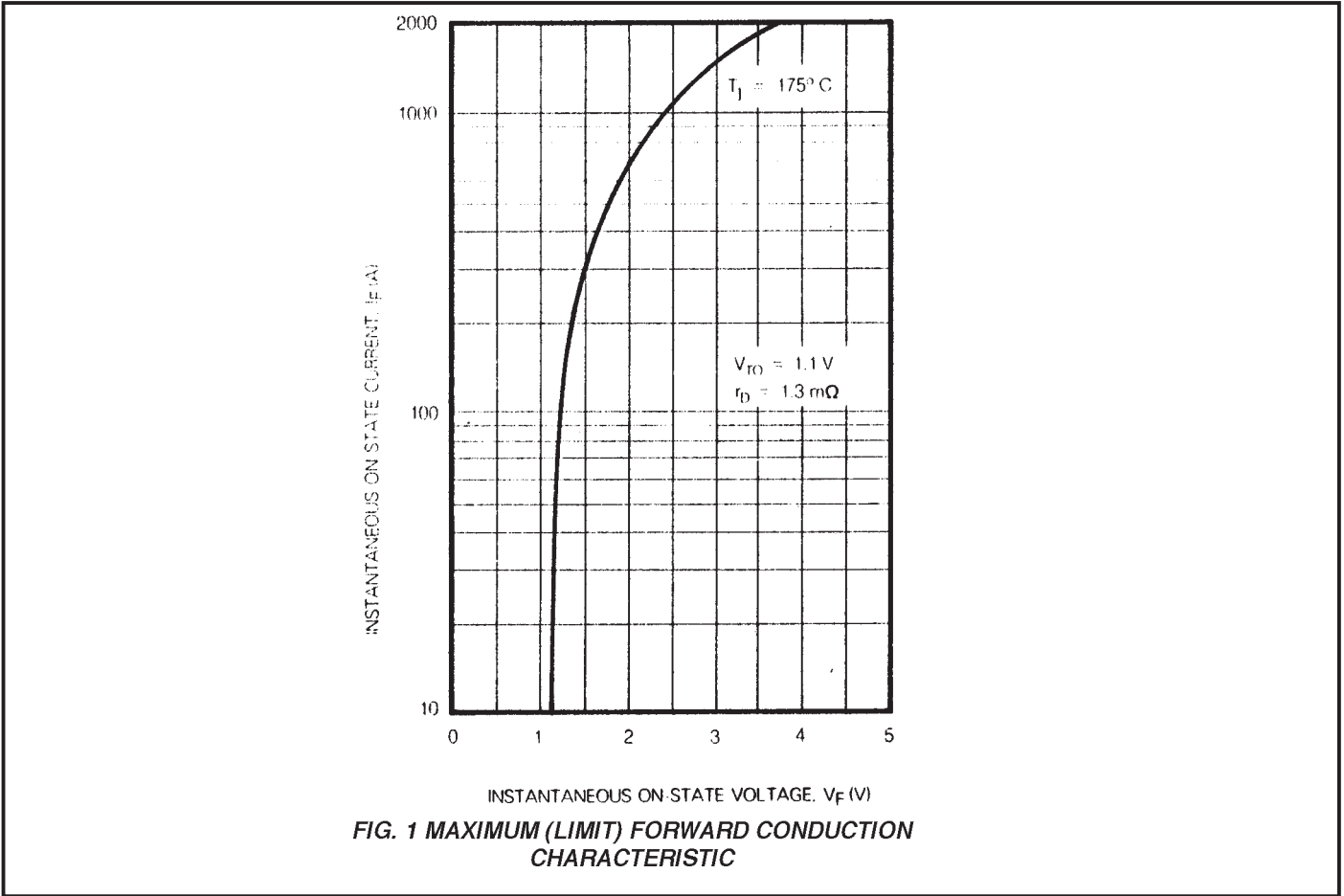

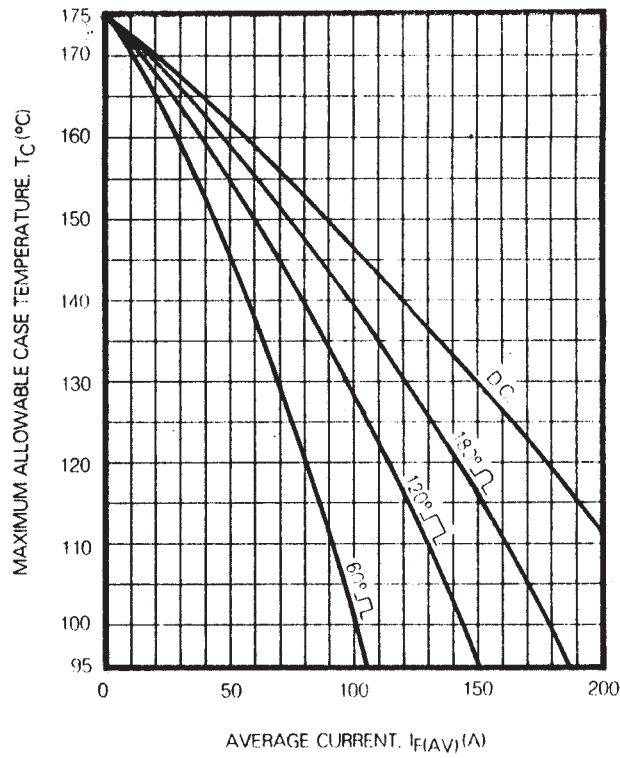

FIG. 3 MAXIMUM ALLOWABLE CASE TEMPERATURE

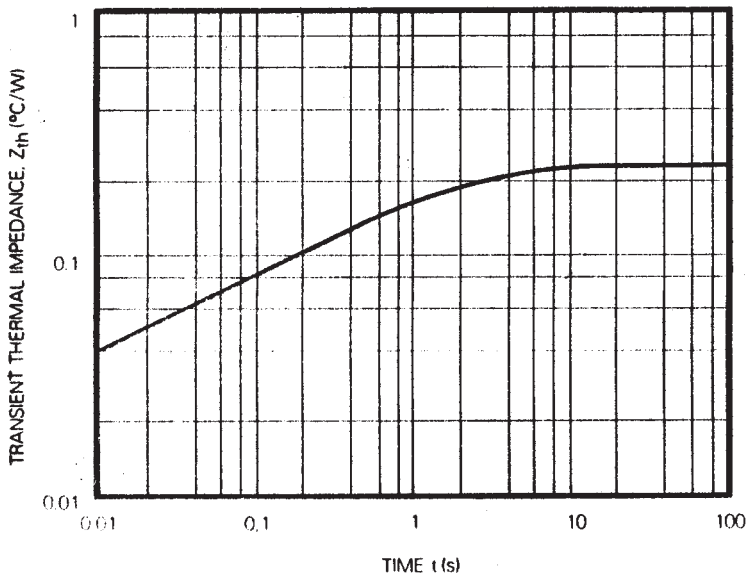
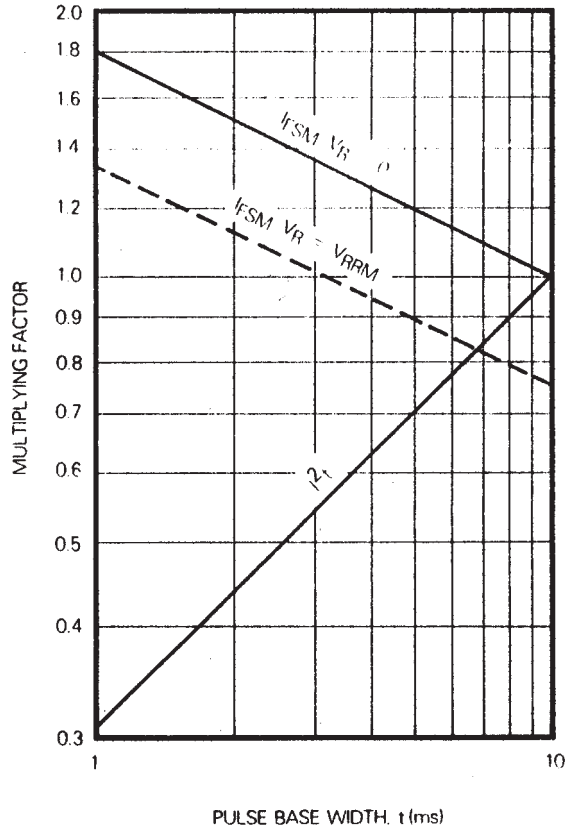
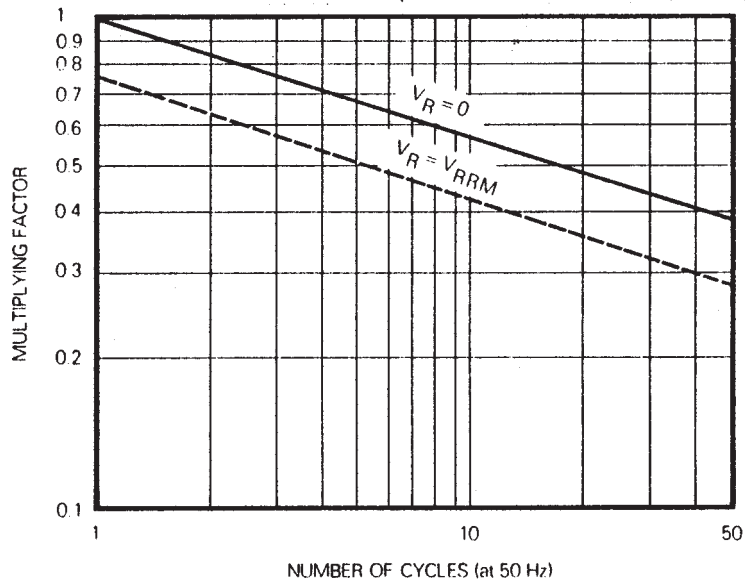

FIG. 4 TRANSIENT THERMAL IMPEDANCE - JUNCTION TO CASE

Conduction angle	Effective thermal Resistance (°C/W) Junction to case	
	Sinusoidal	Rectangular
180°	0.248	0.276
120°	0.258	0.311
60°	0.299	0.391



**FIG. 5 MULTIPLYING FACTOR FOR NON-REPETITIVE SUB-CYCLE FORWARD CURRENT AND  $I_2 t$  RATING**

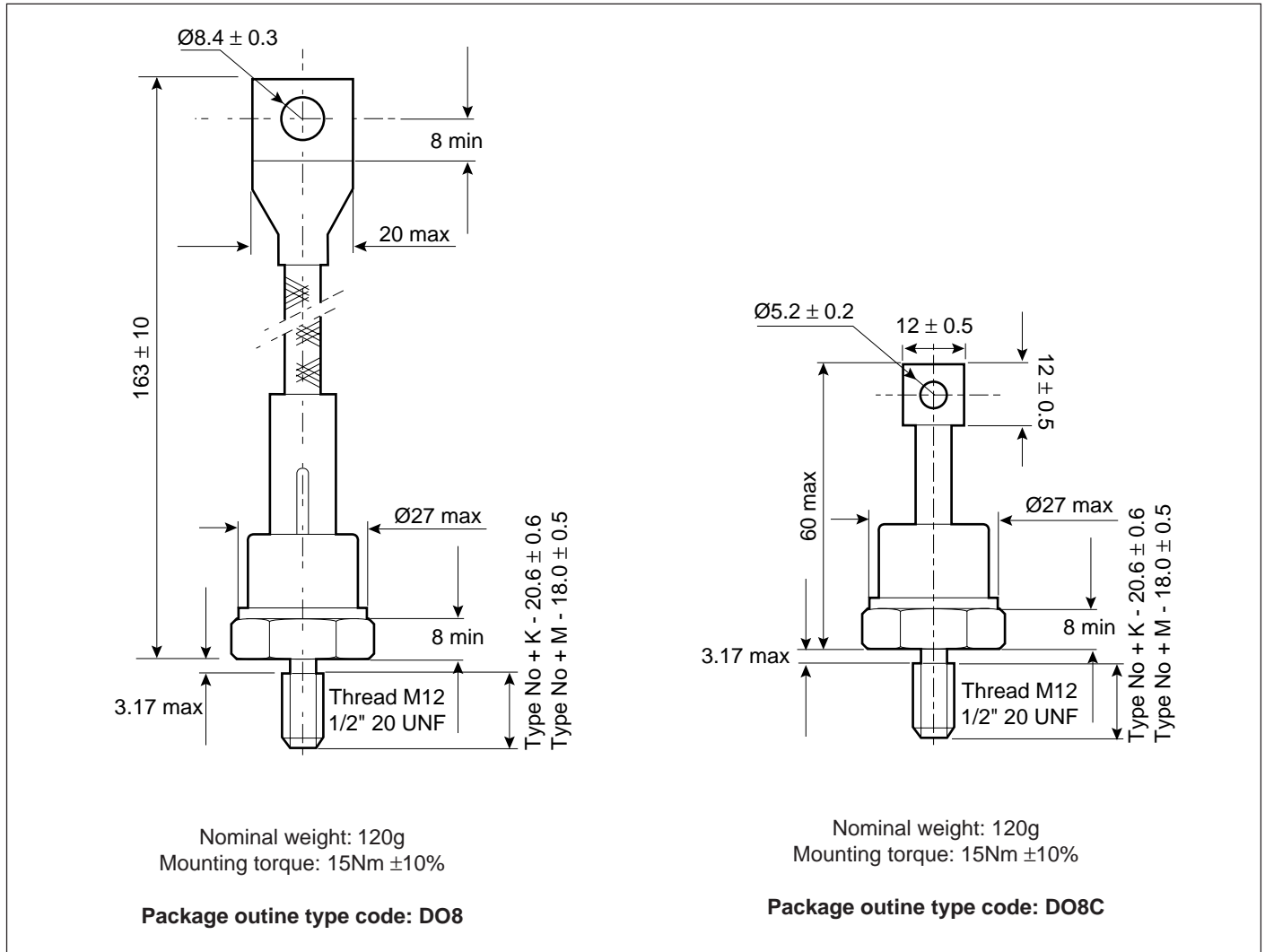

**FIG. 6 MULTIPLYING FACTOR FOR NON-REPETITIVE FORWARD CURRENT**

# SV10

## PACKAGE DETAILS

For further package information, please contact your local Customer Service Centre. All dimensions in mm, unless stated otherwise. DO NOT SCALE.



## ASSOCIATED PUBLICATIONS

Title	Application Note
	Number
Calculating the junction temperature or power semiconductors	AN4506
Thyristor and diode measurement with a multi-meter	AN4853
Use of $V_{TO}$ , $r_T$ on-state characteristic	AN5001

## POWER ASSEMBLY CAPABILITY

The Power Assembly group was set up to provide a support service for those customers requiring more than the basic semiconductor, and has developed a flexible range of heatsink / clamping systems in line with advances in device types and the voltage and current capability of our semiconductors.

We offer an extensive range of air and liquid cooled assemblies covering the full range of circuit designs in general use today. The Assembly group continues to offer high quality engineering support dedicated to designing new units to satisfy the growing needs of our customers.

Using the up to date CAD methods our team of design and applications engineers aim to provide the Power Assembly Complete solution (PACs).

## DEVICE CLAMPS

Disc devices require the correct clamping force to ensure their safe operation. The PACs range offers a varied selection of pre-loaded clamps to suit all of our manufactured devices. This include cube clamps for single side cooling of 'T' 22mm

Clamps are available for single or double side cooling, with high insulation versions for high voltage assemblies.

Please refer to our application note on device clamping, AN4839

## HEATSINKS

Power Assembly has it's own proprietary range of extruded aluminium heatsinks. They have been designed to optimise the performance of our semiconductors. Data with respect to air natural, forced air and liquid cooling (with flow rates) is available on request.

For further information on device clamps, heatsinks and assemblies, please contact your nearest Sales Representative or the factory.



<http://www.dynexsemi.com>

e-mail: [power\\_solutions@dynexsemi.com](mailto:power_solutions@dynexsemi.com)

HEADQUARTERS OPERATIONS  
**DYNEX SEMICONDUCTOR LTD**  
 Doddington Road, Lincoln.  
 Lincolnshire. LN6 3LF. United Kingdom.  
 Tel: 00-44-(0)1522-500500  
 Fax: 00-44-(0)1522-500550

**DYNEX POWER INC.**  
 Unit 7 - 58 Antares Drive,  
 Nepean, Ontario, Canada K2E 7W6.  
 Tel: 613.723.7035  
 Fax: 613.723.1518  
 Toll Free: 1.888.33.DYNEX (39639)

CUSTOMER SERVICE CENTRES  
**France, Benelux, Italy and Spain** Tel: +33 (0)1 69 18 90 00. Fax: +33 (0)1 64 46 54 50  
**North America** Tel: 011-800-5554-5554. Fax: 011-800-5444-5444  
**UK, Germany, Scandinavia & Rest Of World** Tel: +44 (0)1522 500500. Fax: +44 (0)1522 500020

SALES OFFICES  
**France, Benelux, Italy and Spain** Tel: +33 (0)1 69 18 90 00. Fax: +33 (0)1 64 46 54 50  
**Germany** Tel: 07351 827723  
**North America** Tel: (613) 723-7035. Fax: (613) 723-1518. Toll Free: 1.888.33.DYNEX (39639) /  
 Tel: (831) 440-1988. Fax: (831) 440-1989 / Tel: (949) 733-3005. Fax: (949) 733-2986.  
**UK, Germany, Scandinavia & Rest Of World** Tel: +44 (0)1522 500500. Fax: +44 (0)1522 500020  
 These offices are supported by Representatives and Distributors in many countries world-wide.  
 © Dynex Semiconductor 2000 Publication No. DS4084-3 Issue No. 3.0 January 2000  
 TECHNICAL DOCUMENTATION – NOT FOR RESALE. PRINTED IN UNITED KINGDOM

### Datasheet Annotations:

Dynex Semiconductor annotate datasheets in the top right hand corner of the front page, to indicate product status. The annotations are as follows:-

**Target Information:** This is the most tentative form of information and represents a very preliminary specification. No actual design work on the product has been started.

**Preliminary Information:** The product is in design and development. The datasheet represents the product as it is understood but details may change.

**Advance Information:** The product design is complete and final characterisation for volume production is well in hand.

**No Annotation:** The product parameters are fixed and the product is available to datasheet specification.

This publication is issued to provide information only which (unless agreed by the Company in writing) may not be used, applied or reproduced for any purpose nor form part of any order or contract nor to be regarded as a representation relating to the products or services concerned. No warranty or guarantee express or implied is made regarding the capability, performance or suitability of any product or service. The Company reserves the right to alter without prior notice the specification, design or price of any product or service. Information concerning possible methods of use is provided as a guide only and does not constitute any guarantee that such methods of use will be satisfactory in a specific piece of equipment. It is the user's responsibility to fully determine the performance and suitability of any equipment using such information and to ensure that any publication or data used is up to date and has not been superseded. These products are not suitable for use in any medical products whose failure to perform may result in significant injury or death to the user. All products and materials are sold and services provided subject to the Company's conditions of sale, which are available on request.

All brand names and product names used in this publication are trademarks, registered trademarks or trade names of their respective owners.