

**Features**

- 2GHz gain-bandwidth product
- Gain-of-10 stable
- Conventional voltage-feedback topology
- Low offset voltage = 200 $\mu$ V
- Low bias current = 2 $\mu$ A
- Low offset current = 0.1 $\mu$ A
- Output current = 50mA over temperature
- Fast settling = 13ns to 0.1%

**Applications**

- Active filters/integrators
- High-speed signal processing
- ADC/DAC buffers
- Pulse/RF amplifiers
- Pin diode receivers
- Log amplifiers
- Photo multiplier amplifiers
- High speed sample-and-holds

**Ordering Information**

Part No.	Temp. Range	Package	Outline #
EL2075CN	0°C to +75°C	8-Pin P-DIP	MDP0031
EL2075CS	0°C to +75°C	8-Lead SO	MDP0027

**General Description**

The EL2075C is a precision voltage-feedback amplifier featuring a 2GHz gain-bandwidth product, fast settling time, excellent differential gain and differential phase performance, and a minimum of 50mA output current drive over temperature.

The EL2075C is gain-of-10 stable with a -3dB bandwidth of 400MHz at  $A_V = +10$ . It has a very low 200 $\mu$ V of input offset voltage, only 2 $\mu$ A of input bias current, and a fully symmetrical differential input. Like all voltage-feedback operational amplifiers, the EL2075C allows the use of reactive or non-linear components in the feedback loop. This combination of speed and versatility makes the EL2075C the ideal choice for all op-amp applications at a gain of 10 or greater requiring high speed and precision, including active filters, integrators, sample-and-holds, and log amps. The low distortion, high output current, and fast settling makes the EL2075C an ideal amplifier for signal-processing and digitizing systems.

**Connection Diagrams**

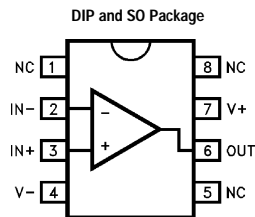

Note: All information contained in this data sheet has been carefully checked and is believed to be accurate as of the date of publication; however, this data sheet cannot be a "controlled document". Current revisions, if any, to these specifications are maintained at the factory and are available upon your request. We recommend checking the revision level before finalization of your design documentation.

# EL2075C

## 2GHz GBWP Gain-of-10 Stable Operational Amplifier

### Absolute Maximum Ratings ( $T_A = 25^\circ\text{C}$ )

Supply Voltage ( $V_S$ )	$\pm 7\text{V}$	$\theta_{JA} = 175^\circ\text{C/W SO-8}$
Output Current Output is short-circuit protected to ground, however, maximum reliability is obtained if $I_{OUT}$ does not exceed 70mA.		Operating Temperature 0°C to +75°C
Common-Mode Input	$\pm V_S$	Junction Temperature 175°C
Differential Input Voltage	5V	Storage Temperature -60°C to +150°C
Thermal Resistance	$\theta_{JA} = 95^\circ\text{C/W P-DIP}$	Note: See EL2071/EL2171 for Thermal Impedance curves.

#### Important Note:

All parameters having Min/Max specifications are guaranteed. Typ values are for information purposes only. Unless otherwise noted, all tests are at the specified temperature and are pulsed tests, therefore:  $T_J = T_C = T_A$ .

### Open Loop DC Electrical Characteristics

$V_S = \pm 5\text{V}$ ,  $R_L = 100\Omega$ , unless otherwise specified

Parameter	Description	Test Conditions	Temp	Min	Typ	Max	Unit
$V_{OS}$	Input Offset Voltage	$V_{CM} = 0\text{V}$	25°C		0.2	1	mV
			$T_{MIN}, T_{MAX}$			2.5	mV
$TCV_{OS}$	Average Offset Voltage Drift	[1]	All		8		$\mu\text{V}/^\circ\text{C}$
$I_B$	Input Bias Current	$V_{CM} = 0\text{V}$	All		2	6	$\mu\text{A}$
$I_{OS}$	Input Offset Current	$V_{CM} = 0\text{V}$	25°C		0.1	1	$\mu\text{A}$
			$T_{MIN}, T_{MAX}$			2	$\mu\text{A}$
$PSRR$	Power Supply Rejection Ratio	[2]	All	70	90		dB
$CMRR$	Common Mode Rejection Ratio	[3]	All	70	90		dB
$I_S$	Supply Current—Quiescent	No Load	25°C		21	25	mA
			$T_{MIN}, T_{MAX}$			25	mA
$R_{IN}(\text{diff})$	$R_{IN}$ (Differential)	Open-Loop	25°C		15		$\text{k}\Omega$
$C_{IN}(\text{diff})$	$C_{IN}$ (Differential)	Open-Loop	25°C		1		pF
$R_{IN}(\text{cm})$	$R_{IN}$ (Common-Mode)		25°C		1		$\text{M}\Omega$
$C_{IN}(\text{cm})$	$C_{IN}$ (Common-Mode)		25°C		1		pF
$R_{OUT}$	Output Resistance		25°C		50		$\text{m}\Omega$
$CMIR$	Common-Mode Input Range		25°C	$\pm 3$	$\pm 3.5$		V
			$T_{MIN}, T_{MAX}$	$\pm 2.5$			V
$I_{OUT}$	Output Current		All	50	70		mA
$V_{OUT}$	Output Voltage Swing	No Load	All	$\pm 3.5$	$\pm 4$		V
$V_{OUT 100}$	Output Voltage Swing	100 $\Omega$	All	$\pm 3$	$\pm 3.6$		V
$V_{OUT 50}$	Output Voltage Swing	50 $\Omega$	All	$\pm 2.5$	$\pm 3.4$		V
$A_{VOL 100}$	Open-Loop Gain	100 $\Omega$	25°C	1000	2800		V/V
			$T_{MIN}, T_{MAX}$	800			V/V
$A_{VOL 50}$	Open-Loop Gain	50 $\Omega$	25°C	800	2300		V/V
			$T_{MIN}, T_{MAX}$	600			V/V
$eN@ > 1\text{MHz}$	Noise Voltage 1–100MHz		25°C		2.3		nV/ $\sqrt{\text{Hz}}$
$iN@ > 100\text{kHz}$	Noise Current 100k–100MHz		25°C		3.2		pA/ $\sqrt{\text{Hz}}$

1. Measured from  $T_{MIN}, T_{MAX}$ .
2.  $\pm V_{CC} = \pm 4.5\text{V}$  to 5.5V.
3.  $\pm V_{IN} = \pm 2.5\text{V}$ ,  $V_{OUT} = 0\text{V}$

### Closed Loop AC Electrical Characteristics

$V_S = \pm 5V$ ,  $A_V = +20$ ,  $R_f = 1500\Omega$ ,  $R_L = 100\Omega$  unless otherwise specified.

Parameter	Description	Test Conditions	Temp	Min	Typ	Max	Unit
SSBW	-3dB Bandwidth ( $V_{OUT} = 0.4V_{PP}$ )	$A_V = +10$	25°C		400		MHz
		$A_V = +20$	25°C	150	200		MHz
			$T_{MIN}, T_{MAX}$		125		
		$A_V = +50$	25°C		40		MHz
GBWP	Gain-Bandwidth Product	$A_V = +100$	25°C		2.0		GHz
LSBWa	-3dB Bandwidth	$V_{OUT} = 2V_{PP}^{[1]}$	All	80	128		MHz
LSBWb	-3dB Bandwidth	$V_{OUT} = 5V_{PP}^{[1]}$	All	32	50		MHz
GFPL	Peaking (<50MHz)	$V_{OUT} = 0.4V_{PP}$	25°C		0	0.5	dB
			$T_{MIN}, T_{MAX}$			0.5	dB
GFPH	Peaking (>50MHz)	$V_{OUT} = 0.4V_{PP}$	25°C		0	1	dB
			$T_{MIN}, T_{MAX}$			1	dB
GFR	Roll-off (<100MHz)	$V_{OUT} = 0.4V_{PP}$	25°C		0.1	0.5	dB
			$T_{MIN}, T_{MAX}$			0.5	dB
LPD	Linear Phase Deviation (<100MHz)	$V_{OUT} = 0.4V_{PP}$	All		1	1.8	°
PM	Phase Margin	$A_V = +10$	25°C		60		°
tr1, tf1	Rise Time, Fall Time	0.4V Step, $A_V = +10$	25°C		1.2		ns
tr2, tf2	Rise Time, Fall Time	5V Step, $A_V = +10$	25°C		6		ns
ts1	Settling to 0.1% ( $A_V = -20$ )	2V Step	25°C		13		ns
ts2	Settling to 0.01% ( $A_V = -20$ )	2V Step	25°C		25		ns
OS	Overshoot	2V Step, $A_V = +10$	25°C		10		%
SR	Slew Rate	2V Step, $A_V = +10$	All	500	800		V/ $\mu$ s
DISTORTION <sup>[2]</sup>							
HD2	2nd Harmonic Distortion	@ 20MHz, $A_V = +20$	25°C		-40	-30	dBc
			$T_{MIN}, T_{MAX}$			-30	dBc
HD3	3rd Harmonic Distortion	@ 20MHz, $A_V = +20$	25°C		-65	-50	dBc
			$T_{MIN}, T_{MAX}$			-50	dBc

1. Large-signal bandwidth calculated using  $LSBW = Slew\ Rate / (2\pi \cdot V_{PEAK})$ .
2. All distortion measurements are made with  $V_{OUT} = 2V_{PP}$ ,  $R_L = 100\Omega$ .

# EL2075C

2GHz GBWP Gain-of-10 Stable Operational Amplifier

## Typical Performance Curves

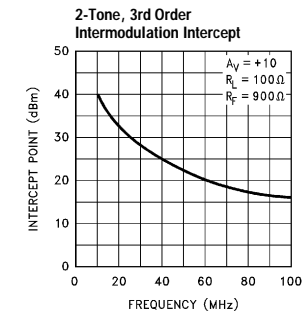
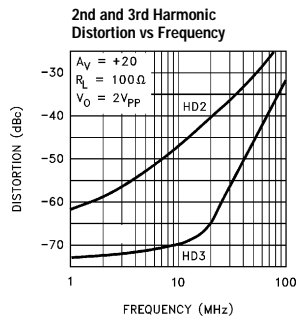
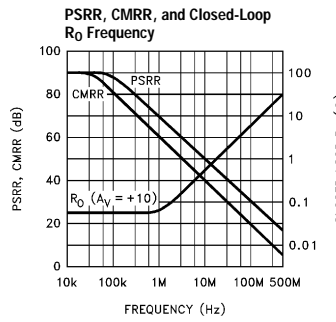
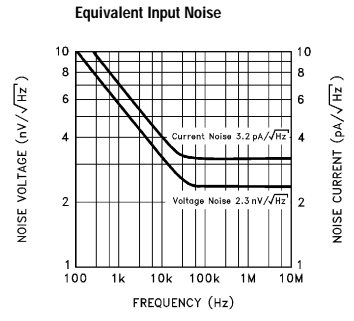
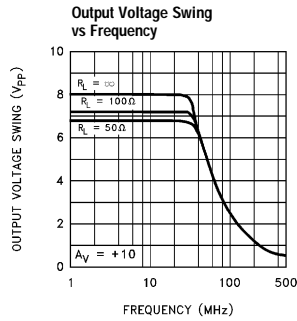
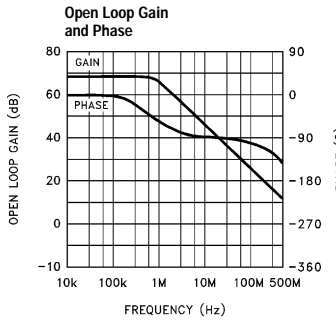
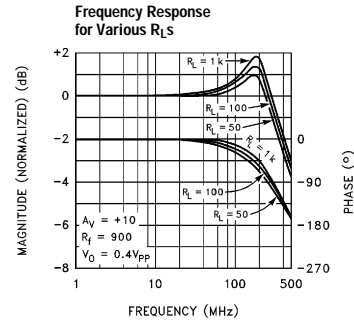
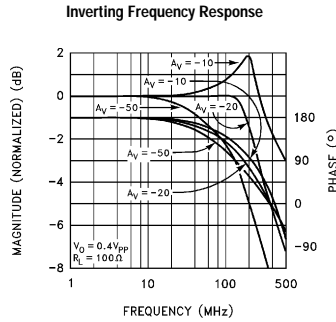
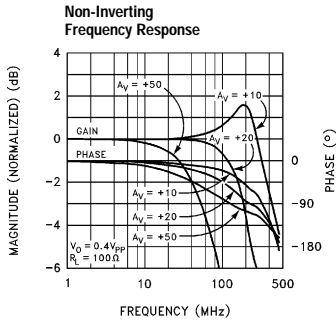

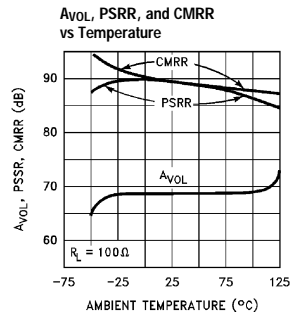
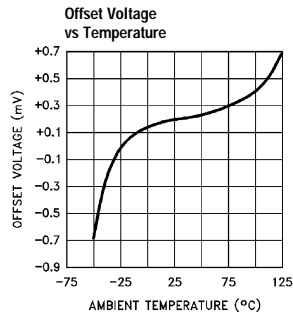
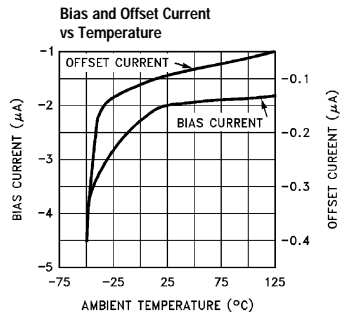
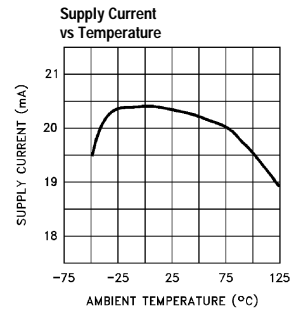
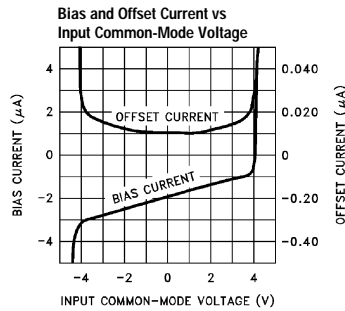
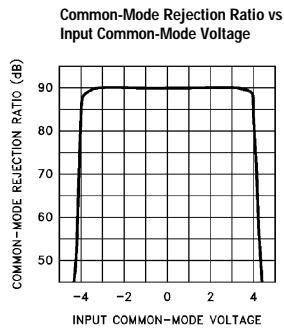
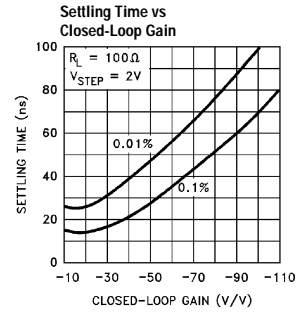
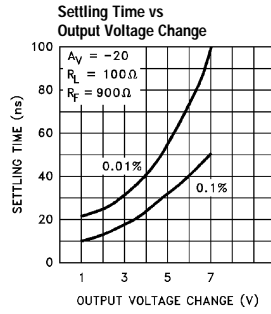
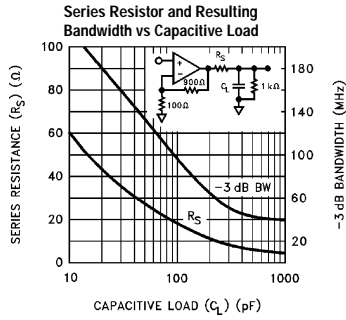

# EL2075C

2GHz GBWP Gain-of-10 Stable Operational Amplifier

Small Signal Transient Response

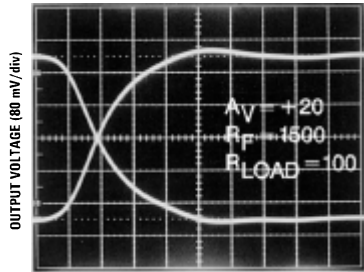

TIME (1ns/div)

Large Signal Transient Response

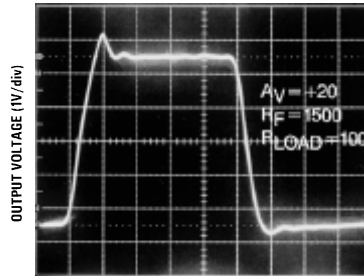

TIME (10ns/div)

**Equivalent Circuit**

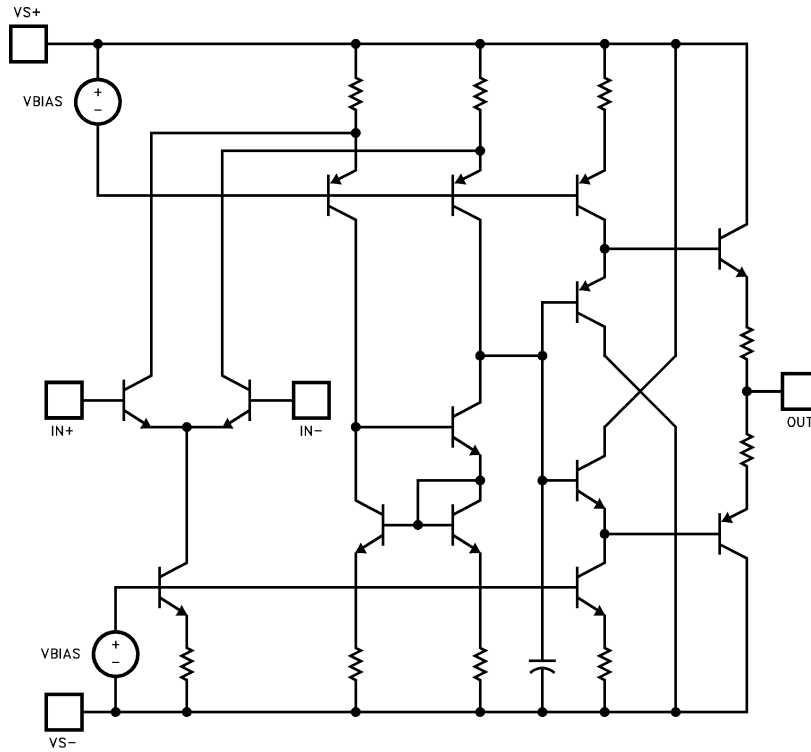

**Burn-In Circuit**

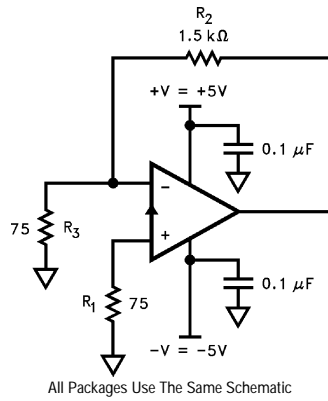

# EL2075C

2GHz GBWP Gain-of-10 Stable Operational Amplifier

## Applications Information

### Product Description

The EL2075C is a wideband monolithic operational amplifier built on a high-speed complementary bipolar process. The EL2075C uses a classical voltage-feedback topology which allows it to be used in a variety of applications requiring a noise gain  $\geq 10$  where current-feedback amplifiers are not appropriate because of restrictions placed upon the feedback element used with the amplifier. The conventional topology of the EL2075C allows, for example, a capacitor to be placed in the feedback path, making it an excellent choice for applications such as active filters, sample-and-holds, or integrators. Similarly, because of the ability to use diodes in the feedback network, the EL2075C is an excellent choice for applications such as log amplifiers.

The EL2075C also has excellent DC specifications:  $200\mu\text{V}$   $V_{OS}$ ,  $2\mu\text{A}$   $I_B$ ,  $0.1\mu\text{A}$   $I_{OS}$ , and 90dB of CMRR. These specifications allow the EL2075C to be used in DC-sensitive applications such as difference amplifiers. Furthermore, the current noise of the EL2075C is only  $3.2\text{ pA}/\sqrt{\text{Hz}}$ , making it an excellent choice for high-sensitivity transimpedance amplifier configurations.

### Gain-Bandwidth Product

The EL2075C has a gain-bandwidth product of 2GHz. For gains greater than 40, its closed-loop -3dB bandwidth is approximately equal to the gain-bandwidth product divided by the noise gain of the circuit. For gains less than 40, higher-order poles in the amplifier's transfer function contribute to even higher closed loop bandwidths. For example, the EL2075C has a -3dB bandwidth of 400MHz at a gain of +10, dropping to 200MHz at a gain of +20. It is important to note that the EL2075C has been designed so that this "extra" bandwidth in low-gain applications does not come at the expense of stability. As seen in the typical performance curves, the EL2075C in a gain of +10 only exhibits 1.5dB of peaking with a  $100\Omega$  load.

### Output Drive Capability

The EL2075C has been optimized to drive  $50\Omega$  and  $75\Omega$  loads. It can easily drive  $6V_{PP}$  into a  $50\Omega$  load. This high output drive capability makes the EL2075C an ideal

choice for RF and IF applications. Furthermore, the current drive of the EL2075C remains a minimum of 50mA at low temperatures. The EL2075C is current-limited at the output, allowing it to withstand momentary shorts to ground. However, power dissipation with the output shorted can be in excess of the power-dissipation capabilities of the package.

### Capacitive Loads

Although the EL2075C has been optimized to drive resistive loads as low as  $50\Omega$ , capacitive loads will decrease the amplifier's phase margin which may result in peaking, overshoot, and possible oscillation. For optimum AC performance, capacitive loads should be reduced as much as possible or isolated via a series output resistor. Coax lines can be driven, as long as they are terminated with their characteristic impedance. When properly terminated, the capacitance of coaxial cable will not add to the capacitive load seen by the amplifier. Capacitive loads greater than 10pF should be buffered with a series resistor ( $R_s$ ) to isolate the load capacitance from the amplifier output. A curve of recommended  $R_s$  vs  $C_{load}$  has been included for reference. Values of  $R_s$  were chosen to maximize resulting bandwidth without additional peaking.

### Printed-Circuit Layout

As with any high-frequency device, good PCB layout is necessary for optimum performance. Ground-plane construction is highly recommended, as is good power supply bypassing. A  $1\mu\text{F}$ – $10\mu\text{F}$  tantalum capacitor is recommended in parallel with a  $0.01\mu\text{F}$  ceramic capacitor. All lead lengths should be as short as possible, and all bypass capacitors should be as close to the device pins as possible. Parasitic capacitances should be kept to an absolute minimum at both inputs and at the output. Resistor values should be kept under  $1000\Omega$  to  $2000\Omega$  because of the RC time constants associated with the parasitic capacitance. Metal-film and carbon resistors are both acceptable, use of wire-wound resistors is not recommended because of parasitic inductance. Similarly, capacitors should be low-inductance for best performance. If possible, solder the EL2075C directly to the PC board without a socket. Even high quality sockets



# ***EL2075C***

## ***2GHz GBWP Gain-of-10 Stable Operational Amplifier***

**EL2075C**

add parasitic capacitance and inductance which can potentially degrade performance. Because of the degradation of AC performance due to parasitics, the use of

surface-mount components (resistors, capacitors, etc.) is also recommended.

**EL2075C****2GHz GBWP Gain-of-10 Stable Operational Amplifier****EL2075C Macromodel**

```

*
* Connections: input
*
*      |      -input
*      |      |      +Vsupply
*      |      |      -Vsupply
*      |      |      |      output
*      |      |      |      |
.subckt M2075C 3 2 7 4 6
*
* Input Stage
*
ie 37 4 1mA
r6 36 37 15
r7 38 37 15
rc1 7 30 200
rc2 7 39 200
q1 30 3 36 qn
q2 39 2 38 qna
ediff 33 0 39 30 1
rdiff 33 0 1 Meg
*
* Compensation Section
*
ga 0 34 33 0 2m
rh 34 0 500K
ch 34 0 0.4 pF
rc 34 40 50
cc 40 0 0.05 pF
*
* Poles
*
ep 41 0 40 0 1
rpa 41 42 250
cpa 42 0 0.8 pF
rpb 42 43 50
cpb 43 0 0.5 pF
*
* Output Stage
*
ios1 7 50 3.0mA
ios2 51 4 3.0mA
q3 4 43 50 qp
q4 7 43 51 qn
q5 7 50 52 qn
q6 4 51 53 qp
ros1 52 6 2
ros2 6 53 2
*
* Power Supply Current
*
ips 7 4 11.4mA
*
* Models
*
.model qna npn(is800e-18 bf170 tf0.2ns)
.model qn npn(is810e-18 bf200 tf0.2ns)
.model qp pnp(is800e-18 bf200 tf0.2ns)
.ends

```

# EL2075C

2GHz GBWP Gain-of-10 Stable Operational Amplifier

## General Disclaimer

Specifications contained in this data sheet are in effect as of the publication date shown. Elantec, Inc. reserves the right to make changes in the circuitry or specifications contained herein at any time without notice. Elantec, Inc. assumes no responsibility for the use of any circuits described herein and makes no representations that they are free from patent infringement.

**élantec**

HIGH PERFORMANCE ANALOG INTEGRATED CIRCUITS

## Elantec Semiconductor, Inc.

675 Trade Zone Blvd.

Milpitas, CA 95035

Telephone: (408) 945-1323

(888) ELANTEC

Fax: (408) 945-9305

European Office: +44-118-977-6020

Japan Technical Center: +81-45-682-5820

## WARNING - Life Support Policy

Elantec, Inc. products are not authorized for and should not be used within Life Support Systems without the specific written consent of Elantec, Inc. Life Support systems are equipment intended to support or sustain life and whose failure to perform when properly used in accordance with instructions provided can be reasonably expected to result in significant personal injury or death. Users contemplating application of Elantec, Inc. Products in Life Support Systems are requested to contact Elantec, Inc. factory headquarters to establish suitable terms & conditions for these applications. Elantec, Inc.'s warranty is limited to replacement of defective components and does not cover injury to persons or property or other consequential damages.